

MITEL NETWORKS

SX-200 EL/ML

GENERAL INFORMATION GUIDE
LIGHTWARE 19, RELEASE 3.0



NOTICE

The information contained in this document is believed to be accurate in all respects but is not warranted by Mitel Networks Corporation (MITEL). The information is subject to change without notice and should not be construed in any way as a commitment by Mitel or any of its affiliates or subsidiaries. Mitel and its affiliates and subsidiaries assume no responsibility for any errors or omissions in this document. Revisions of this document or new editions of it may be issued to incorporate such changes.

SX-200, SX-2000, SUPERSET, ACD TELEMARKEETER, SUPERCONSOLE 1000, MILINK, TALK TO, SMART-1, NuPoint Messenger, Mitel Express Messenger, and LIGHTWARE are trademarks of Mitel Networks Corporation.

VT100 is a trademark of Digital Equipment Corporation
IBM, IBM PC and IBM AT are trademarks of International Business Machines Corporation
Windows is a trademark of Microsoft Corporation
CENTREX is a trademark of Western Electric Company.

Other product names mentioned in this document may be trademarks of their respective companies and are hereby acknowledged.

SX-200 EL/SX-200 ML General Information Guide

LIGHTWARE 19, Release 3.0

50002721, Revision A

October 2002

®,™ Trademark of Mitel Networks Corporation
©Copyright 2002, Mitel Networks Corporation
All rights reserved

Product Overview	1
History	1
The Theme - Flexibility, Reliability, Usability	4
SX-200 [®] EL System	5
SX-200 ML System	7
SX-200 ELx Cabinet	8
SX-200 LIGHT Peripheral Cabinet	9
SX-200 SPINE Peripheral Bay	10
SX-200 IP Node	11
SX-200 EL/ML Peripheral Devices	12
Voice Capabilities	13
Data Capabilities	17
Supporting Applications	19
Voice over IP (VoIP)	19
Business/Commercial/Institutional	19
Hotel/Motel	19
Assisted Living	20
Call Management	21
ACD TELEMARKETER [®] Application	22
Automated Attendant	22
MITEL [®] MyAttendant	23
FAX Tone Detection	23
Centralized Attendant	23
Centralized Voice Mail	24
Tenanting	24
MITEL Application Interface (MAI) Package	24
Data Switching	24
NuPoint Messenger [™]	25
Mitel Express Messenger	25
MITEL TAPI [™] Desktop Software	25
Mitel Networks [™] 6100 Contact Center Solutions	26
Mitel Networks 6500 Speech-Enabled Applications	27
ISDN Support	28
Basic Rate Interface Card	29
ISDN Primary Rate Interface Card	29
ISDN Network Gateway (North America only)	31
SX-200 MyAdministrator	31
System Fail Transfer	32
Configuration	33
SX-200 EL System Configuration	34
SX-200 EL Control Cabinet	34
Connecting Peripheral Bays	40
Connecting SX-200 IP Nodes	42
Maximum Number of T1 Links	43

- SX-200 ML System Configuration 43
 - Connecting a Peripheral Bay 47
- SX-200 ML (FD) System Configuration 48
- SX-200 RM Peripheral Cabinet 50
- SX-200 LIGHT Peripheral Cabinet 51
- Peripheral Interface Cards and Modules 52
- Digital Control and Digital Services Cards and Modules 54
- SX-200 Wall Mount Bracket 57
- SX-200 SPINE Bay 58
- SX-200 SPINE Modules 58
- Power Supplies 59
 - Bay Power Supply 59
 - Power Module II 59
 - Uninterruptible Power Supply (UPS) 59
- System Fail Transfer 60
- Peripherals 63**
 - Introduction 63
 - Mitel Networks 5000 Series IP Phones 64
 - Mitel Networks 5010 IP Phone 64
 - Mitel Networks 5020 IP Phone 65
 - Mitel Networks 5215 IP Phone 66
 - Mitel Networks 5220 IP Phone 67
 - Mitel Networks 5305 IP Office Conference Unit 68
 - Mitel Networks 5310 IP Board Room Conference Unit 69
 - Attendant Consoles 70
 - SUPERCONSOLE 1000® Attendant Console 71
 - SUPERSET™ 7000 Attendant Console 72
 - SUPERSET 4000 Series Telephones 73
 - SUPERSET 4001 Telephone 75
 - SUPERSET 4015 Telephone 76
 - SUPERSET 4025 Telephone 77
 - SUPERSET 4090 Telephone 78
 - SUPERSET 4125 Telephone 79
 - SUPERSET 4150 Telephone 80
 - Programmable Key Modules 81
 - Mitel Networks 5410 Programmable Key Module 81
 - Mitel Networks 5415 Programmable Key Module 82
 - Mitel Networks Programmable Key Module 12 83
 - Mitel Networks Programmable Key Module 48 84
 - Interface Modules 85
 - SUPERSET Interface Module 1 85
 - SUPERSET Interface Module 2 86
 - DSS/BLF Interface Unit 87
 - Music-On-Hold/Pager Unit (DMP) 88
 - Datasets 89

DATASET 1103 Standalone	90
DATASET 2103 Standalone	91
SMART-1® Devices	92
Digital Line Monitor (DLM)	93
MITEL Express Messenger Voice Mail	93
Auto Attendant Features	94
Voice Mail Features	95
NuPoint Messenger Voice Mail	97
Feature Description	99
Feature Categories	100
Abbreviated Dial	117
Access Codes - Global Find	117
Account Codes	118
Account Codes - Verified	118
Account Codes - Verified (Special DISA)	118
Add Held	118
Analog Networking	119
Attendant Abbreviated Dial Number Entry	119
Attendant Access (Dial 0)	120
Attendant Advisory Message Setup	120
Attendant Alarm Readout	120
Attendant Automatic Overflow	120
Attendant Bell Off	120
Attendant Busy Override	120
Attendant Callback - Busy/No Answer	120
Attendant Call Forward Setup and Cancel	121
Attendant Call Selection	121
Attendant Call Splitting and Swapping	121
Attendant Calls Forwarded On No Answer	121
Attendant Conference	121
Attendant Console Display Language	121
Attendant Console Handset and Headset Receiver Volume Control	121
Attendant Console Last Call Retrieve	122
Attendant Console LCD Display	122
Attendant Console LDN Keys	122
Attendant Console Lockout	122
Attendant Console Macro Keys	123
Attendant Console Set Paging - Directed, Group, or All Set	123
Attendant Date and Time Setup	123
Attendant Default Call Positions	123
Attendant Destination (DEST) Key	123
Attendant Directed Call Pickup	123
Attendant Direct Trunk Select	124
Attendant DISA Code Setup	124
Attendant Do Not Disturb (DND) Setup, Cancel or Override	124
Attendant Emergency Call (911) Detection	124
Attendant Extension Busy-Out	124
Attendant Flash Over Trunk	124
Attendant Function Access	124
Attendant Hold Positions	125
Attendant Implicit New Call	125

Attendant Individual Directory Number 125

Attendant Interposition Calling and Transfer 126

Attendant Lockout Alarm 126

Attendant Message Waiting Setup and Cancel 126

Attendant Multi-New Call Tone 126

Attendant New Call Ring 127

Attendant Night/Day Switching 127

Attendant Paging Access 127

Attendant Paged Hold Access 127

Attendant Serial Call 127

Attendant Source Key 127

Attendant Timed Recall 127

Attendant Tone Signaling 128

Attendant Training Jacks 128

Attendant Transfer To Campon 128

Attendant Transparent Multi-Console Operation 128

Attendant Trunk Busy-Out 128

Attendant Trunk Group Status Display 128

Auto - Answer 129

Auto - Hold 129

Automated Attendant 129

Automated Attendant - Auto-Attendant Group 129

Automated Attendant - Default Destination 130

Automated Attendant - Front End Recording 130

Automated Attendant - Illegal Number Handling 130

Automated Attendant - Prefix Digits 131

Automated Attendant - RAD Operation 131

Automated Attendant - Resource Allocation 131

Automated Attendant - Vacant Number Routing 131

Automatic Call Distribution (ACD) 131

ACD - Path 132

ACD - Positions 132

ACD - Displays 132

ACD - Longest Idle Agent 132

ACD - Mobility 132

ACD - Predictive Overflow 133

ACD - Printed Reports 133

ACD - Real Time Event 133

ACD - Recorded Announcements 133

ACD - Sets 134

Automatic Number Identification (ANI) on Outgoing Trunks 134

Automatic Number Identification (ANI) / Dialed Number Identification
Service (DNIS) on Incoming Trunks 134

Automatic Number Identification (ANI) on Outgoing Trunks 135

Automatic Route Selection (ARS) 135

Background Music 136

BRI Card Support 136

Broker's Call (Station Swap) 136

Broker's Call With Transfer (Transfer With Privacy) 136

Busy Lamp Field 136

Calculator 137

Call Forwarding 137

Call Logging 138

Call Park from Single-line Sets	139
Call Park from Multi-line Sets	139
Call Park System Orbit	139
Call Rerouting	139
Callback	139
Campon	140
Campon Priority Over Call Forward Busy	140
Campon Warning Tone	140
Centralized Attendant	140
CENTREX Compatibility (Double Flash Over Trunk)	140
CENTREX Compatibility (Single Flash Over Trunk)	141
CLASS (Custom Local Area Signaling Services) for Analog Telephones	141
CLASS (Custom Local Area Signaling Services) for Digital Sets	141
Class of Restriction (COR)	141
Class of Service (COS)	141
Clear All Features	142
CO Line Group Key	142
CO Line Key	142
CO Line - Select Direct	142
CO Line Type - Direct Access - Bypass Key System Toll Control	142
Conference	142
Conflict Dialing	142
Consoleless Operation	143
Contact Monitor	143
Customer Data Entry (CDE)	143
Customer Data Entry - Default Data	143
Customer Data Entry - Range Programming	143
Customer Data Print	143
Data: Abbreviated Dial For ADL Calls	143
Data: Account Codes	143
Data: Associated Data Line (ADL)	144
Data: ADL Hotline	144
Data: ADL Speed Call Originate	144
Data: Associated Modem Line (AML)	144
Data: Auto Answer	144
Data: Automatic Data Route Selection (ADRS)	145
Data: Hunt Groups	145
Data: Modem Pooling	145
Data: Modem Pooling Queuing	145
Data: Peripherals	145
Data: Security	146
Data: Station Message Detail Recording (Data SMDR)	146
Data: Station Queuing	146
Data Transceiver (DTRX)	146
Data: DTRX Call by Name	146
Data: DTRX Call Originate/Disconnect	146
Data: DTRX Help	146
Data: DTRX Hotline	146
Data: DTRX Messages	147
Daylight Savings Time Adjustment	147
Device Interconnection Control	147
Dial Tone Disable	147
Dial Tone - Discriminating	147

Dictation Trunks	147
DID/Dial-in/Tie Intercepts	148
Digit Translation	148
Direct-in Lines (DIL)	148
Direct Station Page/Busy Lamp Field	148
Direct Station Select (DSS) Key	148
Direct Station Select/Busy Lamp Field (DSS/BLF)	149
Direct Station Select/Busy Lamp Field (DSS/BLF) Call Pickup	149
Direct Station Select/Busy Lamp Field (DSS/BLF) Interface Unit	149
Direct to ARS	149
Direct Trunk Select	149
Disconnect Alarm	149
Display Caller ID on Non-Prime Lines	150
Display Keys	150
Do Not Disturb (DND)	150
DTMF-To-Rotary Dial Conversion	150
Emergency Call Handling	150
Emergency Calls (911) - Detection and Reporting to Attendant Consoles	150
Emergency Calls (911) - Detection and Reporting to Display Sets	151
Emergency Calls (911) - Reporting to PSAP	152
Expensive Route Warning	152
FAX Tone Detection	152
Feature Keys	152
Flash - Calibrated	155
Flash Control	155
Flash Disable	156
Flash For Dial 0 (Attendant)	156
Flash For Waiting Call	156
Flash Timing	156
Forward Campon	156
Group Listening	156
Handset Mute	156
Handset Receiver Volume Control	157
Handsfree Announce	157
Handsfree Answerback to a Directed Page	157
Handsfree Operation	157
Headset Mode Feature Key	157
Headset Operation	157
Headset Operation (Amplified Headset)	158
Headset User Control	158
Headset with In-Line Switch Operation	158
Hold	158
Hold Reminder	158
Holiday Messages	159
Hot Line	159
Hotel/Motel (Lodging)	159
Hotel/Motel - Attendant Console Guest Room Softkey	159
Hotel/Motel - Attendant Message Register Audit	160
Hotel/Motel - Attendant Message Waiting Setup and Cancel	160
Hotel/Motel - Audits	160
Hotel/Motel - Audit Screen	161
Hotel/Motel - Wakeups	161
Hotel/Motel - Call Blocking	162

Hotel/Motel - Call Restriction	162
Hotel/Motel - Check Out	162
Hotel/Motel - CLASS (station side) for Analog Telephones	162
Hotel/Motel - Do Not Disturb (DND)	162
Hotel/Motel - Front Desk Features	163
Hotel/Motel - Guest Names	163
Hotel/Motel - Guest Room Message Retrieval	163
Hotel/Motel - Guest Room SUPERSET Key Programming	163
Hotel/Motel - Guest Room Update Screen	163
Hotel/Motel - Guest Search Screen	164
Hotel/Motel - House Statistics Screen	164
Hotel/Motel - Internal Number Block	164
Hotel/Motel - Maid in Room Status Display - SUPERSET Display Telephones	164
Hotel/Motel - Message Lamp Test	164
Hotel/Motel - Message Register	165
Hotel/Motel - Multi-user	165
Hotel/Motel - Passwords	165
Hotel/Motel - Property Management System (PMS)	166
Hotel/Motel - Room Condition	167
Hotel/Motel - Room Occupancy	167
Hotel/Motel - Room Search Screen	167
Hotel/Motel - Room Status Display	168
Hotel/Motel - Room Types and Room Codes	169
Hotel/Motel - Single Line Reports	169
Hotel/Motel - Suite Services	169
Hunt Groups	169
Illegal Access Intercept	170
Inhibit Trunk Ring-Me-Back During Dialing	170
Intercept To Recorded Announcement	170
Internal Number Block	170
Inward Restriction (DID)	170
Language Change	170
Last Number Redial	171
Last Party Receives Dial Tone	171
Line Lockout	171
Line Preference	171
Line Privacy	171
Line Selection	171
Line Types and Appearances for SUPERSET Telephones	172
Line Appearance Variants	173
Lockout Alarm	174
Logical Lines	174
Maintenance	174
Manual Line (Dial 0 Hotline)	174
Messaging - Advisory	174
Messaging - Call Me Back	174
Meter Pulse Collection	175
MILINK Data Module	175
MITEL Application Interface (MAI)	175
MITEL Network Gateway	176
Moving Stations and SUPERSET Telephones	176
Multi-Attendant Positions	177
Music-on-Hold (MOH)	177

Music from an ONS Source 177

Names 177

Never a Consultee 177

Never a Forwardee 178

New Call Ring 178

NI3 Calling Name Delivery 178

Night Bells 178

Night/Day Switching 178

Night Services 178

Night Services Flexibility 178

Node Identification 179

Non-Busy Extension 179

Numbering Plan Flexibility (Conflict Dialing) 179

Off-Hook Alarm to Display Sets 179

Off-Hook Voice Announce 179

Off Premises Extension (OPS) 179

Originate Only Extension 179

Overlap Outpulsing 179

Override (Intrude) 180

ONS Positive Disconnect 180

ONS Ring Groups 180

Override Security 180

Paging - PA 180

Paging -Telephones 180

Paging - PA and Telephones 181

Parallel Connection of Industry-Standard Telephones 181

Personal Speed Call 181

Pickup Groups 182

Pickup - Local and Directed 182

PRI Card Support 182

Printer/Terminal Support 182

Priority Dial 0 182

Privacy Enable/Privacy Release 183

Programmable Key Module (PKM) 183

Q.SIG 184

RAD Support 184

Recall 184

Receive Only Extensions 184

Record a Call 185

Remote LAN Access 185

Reminder 185

Resale Package 185

Ringer Control 185

Ringling - Discriminating 185

Ringling Plan 185

Ringling Time-Out (Final Ringback) 186

Satellite PBX 186

Secretarial Line 186

Speak@Ease Support (Mitel Networks 6500 Speech-Enabled Applications) 186

Speaker Volume Control 186

Speed Call Key 186

Split 187

Station Message Detail Recording (SMDR) 187

Subattendant - Basic Function	187
Subattendant - Enhanced Functions	187
Subattendant - Abbreviated Dial Programming	188
Subattendant - Advisory Message Setup	188
Subattendant - Wakeups	188
Subattendant - Call Forward Setup and Cancel	188
Subattendant - Calls Waiting Indication	189
Subattendant - Date and Time Setup	189
Subattendant - Hold Positions	189
Subattendant - Listed Directory Number (LDN) Keys	189
Subattendant - Paged Hold Access	190
Subattendant - Recall	190
Subattendant - Station DND Setup	191
SUPERSET 3DN and SUPERSET 4DN Auto-Answer For Directed Page Calls	191
SUPERSET 3DN and SUPERSET 4DN Option	191
SUPERSET LCD Display	191
Swap (Trade Calls)	192
Swap Campon	192
System Fail Transfer (SFT)	192
System Identifier	192
System ID Module	192
Tandem Operation	192
TAPI Support Over DNIC	192
Tenanting	193
Toll Control	193
Tone Demonstration	193
Tone Plans	193
Traffic Measurement	193
Transfer	194
Transfer Dial Tone	194
Transfer Security (Recall)	194
Trunk Answer From Any Station (TAFAS)	194
Trunk Circuit Descriptor Options	194
Trunk Dial Tone Detection	194
Trunk Groups	194
Trunk Operation - Direct Inward Dial (DID)	194
Trunk Operation - Direct Inward System Access (DISA)	195
Trunk Operation - Non-Dial-in CO	195
Trunk Operation - Tie	195
Trunk Recall	195
Trunk Support - CO (LS/GS)	195
Trunk Support - Direct Inward Dial (DID)	196
Trunk Support - E&M	196
Trunk Support - T1	196
Uniform Call Distribution (UCD)	196
Vacant Number Intercept	196
Voice Mail Support	196
Whisper Announce	197
Feature Levels	199
Purchasable System Options	201

Maintenance	205
Introduction	205
Customer Data Entry (CDE)	205
Maintenance Functions	206
Alarm Indication	207
Alarm LEDs	207
Alarm Status Display	207
Configuration Report	207
Copy Database	207
Customer Data Entry (CDE) Backup and Restore	207
Device Error Analysis Statistics	208
Device Status Report	208
Diagnostics	208
Remote Maintenance Administration and Test (RMATS) Access	209
Remote Printing of CDE Reports	209
Remote Software Download	209
Remove from Service, Return to Service	209
Show, Set Date	209
Show, Set System Time	209
SUPERSET Firmware Download	209
System Logging Facility	209
Test Line Function	210
Maintenance Diagnostics	210
Maintenance Objectives	211
RS-232 Maintenance Terminal	211
Diagnostic Log Files	211
Types of Diagnostics	211
Database Installation and Updates	212
Database Storage on Loss of Power	212
Specifications	213
Environment	213
Shipping	213
Storage	213
Site	214
Feature Capacities	215
System Parameters	217
Tone Plan Support	217
Traffic and Performance	217
Traffic Parameters	217
Grade of Service	220
Traffic Limitations	220
Receiver Provisioning	221
SX-200 SPINE CLASS Receivers	222

Physical Characteristics 224

Electrical Characteristics 224

 Power and Grounding 225

 SX-200 IP Node 225

 Cabling 225

Regulatory Compliance 227

Glossary of Terms 229

Product Overview

The SX-200 EL and SX-200 ML systems are a microprocessor-controlled telephone system that handles both voice and data switching. The system hardware is electrically compatible with most

- Single line telephones
- Mitel Networks digital sets
- Key telephone systems
- System telephone systems
- Central office exchanges
- ISDN Networks.

History

The SX-200 system was first developed in 1977 using leading-edge technology from Mitel Semiconductor Division. MITEL customers worldwide participated in its definition.

The SX-200 system was introduced with a feature-rich package - Generic 202. Building on the phenomenal success of the SX-200 PBX, MITEL introduced software and hardware enhancements at the rate of one a year.

Responding to demands for digital technology, in 1985 MITEL introduced the SX-200 DIGITAL PBX as both a migration path for existing SX-200 users and a communications solution for new customers. Most features are fully compatible with the first SX-200 system shipped in 1978. No wonder almost every major telephone company in the world has standardized on the SX-200 family of products!

As an extension of the powerful SX-200, the SX-200 DIGITAL PBX provided a migration path unmatched by any other manufacturer. This, combined with the fact that it could be competitively installed for customers requiring between 40 and 400 lines made the system a logical choice for any small-to-medium-size business.

In 1986, MITEL continued its commitment to meeting customer needs by launching the first fully digital version of the SX-200 DIGITAL system. This system opened the door to a range of applications available with digital technology for new users under 250 lines. The system incorporated custom silicon developed by MITEL, including the DX Chip, (used in the digital switching matrix), and filter codecs (used to convert analog signals to digital PCM format and vice versa).

In 1988, the 672-port system was introduced as an expansion for existing 250-line systems, and for new customers needing up to 500 lines.

Generic 1003 software, introduced at the same time, offered advanced business features such as modem pooling and DATASETs capable of synchronous/asynchronous transmission. In addition, MITEL introduced one of the most flexible ACD Telemarketing packages available.

Generic 1004 software was introduced in 1990, delivering an office package that supports Key System functionality for companies that were interested in having a departmental key system application within their PBX environment. A Front Desk terminal provides a low-cost alternative to a PMS for smaller Hotel/Motel operators. As well it offers Enhanced Subattendant features.

The SX-200 LIGHT PBX and LIGHTWARE 15 software was introduced in 1991, responding to the need for fiber optic technology. At the same time, the SUPERSET 400 series telephones were delivered. This series consists of the SUPERSET 401+, SUPERSET 401, SUPERSET 410, SUPERSET 420 and SUPERSET 430 telephones. The sets are compatible with both the SX-200 LIGHT and SX-200 DIGITAL PBXs. The MILINK[®] Data Module was designed to be placed under the multiline SUPERSET 410, SUPERSET 420 and SUPERSET 430 telephones. Similar to the DATASETS introduced with Generic 1003, the MILINK Data Module provides asynchronous transmission. LIGHTWARE 15 also includes ISDN interface capability, DTMF Automatic Number Identification (ANI) and DTMF Dialed Number Identification Service (DNIS). The Programmable Key Module (PKM) was introduced in later versions of LIGHTWARE 15, providing SUPERSET 410, SUPERSET 420 and SUPERSET 430 telephones with 30 additional personal keys.

The first SX-200 ML PBX, SX-200 ML (FD), was developed using the same vertical cabinet of the SX-200 LIGHT PBX and modifying it to include the system main control. The result was a fiber distributed (FD) single cabinet, 96 port PBX.

LIGHTWARE 16 software was released in 1995 and it introduced the SX-200 SPINE, a peripheral bay containing a peripheral control module, a power module, Loop Start (LS) trunks and LS/CLASS II modules, ONS, DNIC and CLASS modules. The 48 port SX-200 SPINE, fiber optically connected, can be located up to 1006 metres (3300 feet) from the control cabinet.

Release 1.1 of the SX-200 ML PBX provided the SX-200 ML (FD) with an option of a second cabinet or bay. The second cabinet could be a 96 port peripheral cabinet, a 24 or 48 port SPINE, or an ISDN Network Gateway.

LIGHTWARE 17 software was released with the SX-200 ML (RM) and the SX-200 EL PBX. The SX-200 ML system is housed in a horizontal, rack mounted (RM) cabinet and has the same two cabinet limit as the SX-200 ML (FD) PBX. The SX-200 EL is also housed in the horizontal, rack mounted cabinet but supports six peripheral bays. Other features include: a new family of DNIC-based SUPERSET 4000-series telephones, a centralized voice mail, centralized attendant, enhanced paging for key system telephones, interface units that connect programmable key modules to the SUPERSET 4025, SUPERSET 4125, or SUPERSET 4150 telephone, the DSS/BLF (Direct Station Select/Busy Lamp Field) interface unit that connects programmable key modules to an attendant console.

The SX-200 EL and the SX-200 ML systems also offer an access interface to the ISDN Network. This interface is provided by the ISDN Network Gateway peripheral node and the PRI card that installs within the SX-200 ELx cabinet Rev. 4.4 or greater. ISDN provides an international standard for voice, data, and signaling with end-to-end digital compatibility worldwide, regardless of where the telephone terminal is located - in an office or in the home.

LIGHTWARE 18 software was released in the year 2000. Release 1.0 primarily introduced new software features. Release 2.0 is mostly hardware. LIGHTWARE 18 Release 2.0 introduces the BCC III, the BRI card, the ONS/CLASS Line card, the Control Triple CIM card, and the Peripheral Interface Module Carrier card. The BCC III provides extra processing power and holds a DSP module (single) that gives DTMF receivers, Record a Call conference bridges and CLASS generator resources, and a T1/E1 module that provides T1/D4 connectivity, CSU and ESF functionality at a reduced cost. Customers are also delighted with the introduction of the Copper Interface Module (CIM). Not every system requires fiber; the CIM offers you a cost-reduction with a co-located system.

LIGHTWARE 19 software released in 2001 provides functionality with Q.SIG that places the SX-200 system into a branch office network with the MITEL SX-2000 LIGHT system. This major leap is an exciting one for the SX-200 EL/ML system.

LIGHTWARE 19 Release 3.0 brings the cost-saving benefits of Voice over IP (VoIP) technology to the SX-200 EL. The Mitel Networks SX-200 IP Node addresses the IP telephony requirements of

- Small to medium enterprises
- Corporate enterprises with branch offices and teleworkers.

The SX-200 EL supports up to two SX-200 IP Nodes and 120 IP telephones in LIGHTWARE 19 Release 3.0.

The SX-200 family provide a rich foundation of features and a sound digital architecture which allows for even further enhancements in the areas of networking, data handling, applications processing, and, of course, telephony. Most of these enhancements are compatible with every SX-200 system ever produced. Feature enhancements are straightforward with flash memory card upgrades or remote down loads of system software, while new hardware for data interfaces comes in the form of plug-in circuit cards.

MITEL, now named Mitel Networks, has continued to produce enhancements since 1978. The SX-200 EL now offers the customer 768 ports (672 physical ports) with a maximum of 650 lines. The systems will evolve with your needs, in one continuous migration plan. This means that you can buy what you need today, knowing that the SX-200 family will always meet your needs. The SX-200 systems are designed to provide "Communications Answers That Work . . . For You."

The Theme - Flexibility, Reliability, Usability

The SX-200 EL and SX-200 ML systems are advanced microprocessor-control telephone systems that meets the three key customer requirements for installations of up to 650 telephones:

- Flexibility
- Reliability
- Usability.

By designing the SX-200 EL and the SX-200 ML systems for maximum flexibility, we give you the capability of tailoring your system to meet your communications needs. If you are starting a new business, or if your existing telephone system fails to meet your requirements, you can install a completely new SX-200 EL system or SX-200 ML system. If you are among the customers with an installed SX-200 system, you can upgrade your system to the latest technology while protecting your investment in cabinets, building wiring, telephones, and line and trunk circuit cards. Whether a new installation or an upgrade, you can choose the system features and services you need today, with the assurance that you can expand the system at any time in the future.

In today's information-oriented world, every business is concerned with the reliability of its communications system. The SX-200 EL and SX-200 ML systems continue the MITEL tradition of building a solid reliable product backed by our commitment to customer service. The system is designed to operate reliably in a typical business environment. No expensive equipment room or air conditioning is required. If problems should arise, built-in diagnostics and service aids assist the maintainer in quickly isolating and repairing the fault.

Usability is critical. A communications system is cost-effective only if users are able to access the features. The SX-200 EL and the SX-200 ML systems continue the philosophy of designing easy-to-use, highly functional telephone sets that are fully integrated with the features available on the system. And to ensure that we take care of your communications needs today and into the future, the latest series of voice and data sets conform to the evolving ISDN "U" interface standard.

As an introduction to the SX-200 EL and the SX-200 ML system, this guide outlines the various types of features, applications, and services available on the system, the major call management facilities that contribute to the system's flexibility and ease of use, the voice and data peripheral devices that can be connected to the system, and the hardware configurations that allow you to tailor the system to your needs.

SX-200 EL System

The SX-200 EL system can support up to six peripheral bays, cabinets, or SX-200 IP Nodes.

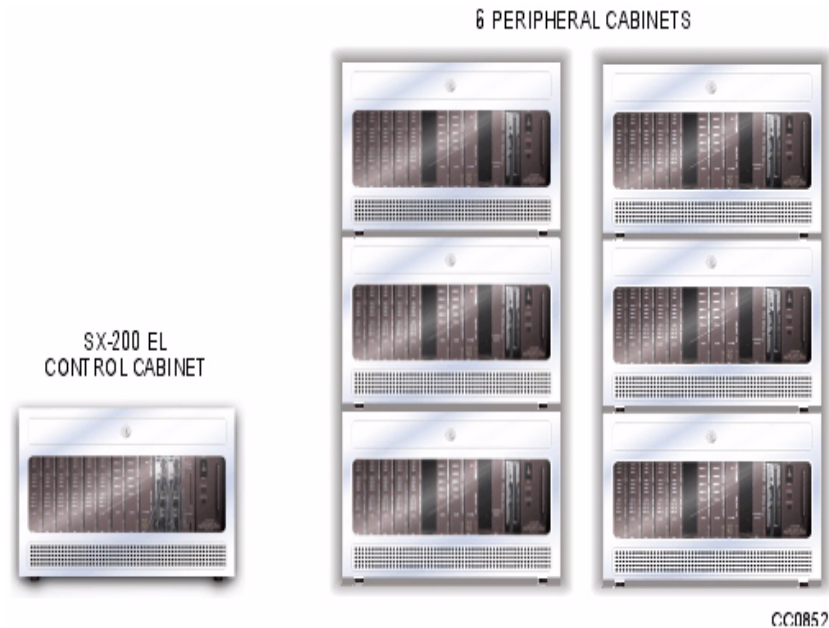

The SX-200 EL System has the following characteristics:

- Main Control Card IIIEL (MCCIIIEL) or Main Control Card IIIELx (MCCIIIELx)
- Bay Control Card II or Bay Control Card III, Bay Power Supply Card, and depending on the configuration, a maximum of two of the following carrier cards: Control Triple FIM Carrier Card, Control Dual FIM Carrier Card, Control Triple CIM Card
- ONS/CLASS Line card, LS/GS card, LS/CLASS Trunk card, Universal card, COV card, DID card, OPS card, DNIC card, PRI card, BRI card, Digital Line card, and T1 card
- Maximum of 96 physical ports using a single cabinet
- Maximum of six Peripheral cabinets, two SX-200 IP Nodes, six SPINE Bays, or six ISDN Bays
- Maximum of 672 physical ports in the system
- Requires LIGHTWARE 17 or greater software. To support the SX-200 IP Node, you must have LIGHTWARE 19 Release 3.0 or greater software.

SX-200 General Information Guide

The six peripheral bays can be SX-200 peripheral cabinets, SX-200 LIGHT peripheral cabinets, SX-200 IP Nodes (requires the MCC IIIELx), SPINE bays, or ISDN bays (A SPINE bay configured as bay 7 requires the MCC IIIELx). The ISDN bay may be an ISDN Network Gateway or a PRI card. The PRI card fits into a main control cabinet or a peripheral cabinet.

PERIPHERAL BAYS



SX-200 PERIPHERAL CABINET



SX-200 IP NODE



SX-200 LIGHT
PERIPHERAL CABINET



ISDN NETWORK GATEWAY



SPINE BAY

CC0851

SX-200 ML System

The SX-200 ML system can support up to one peripheral bay or cabinet.

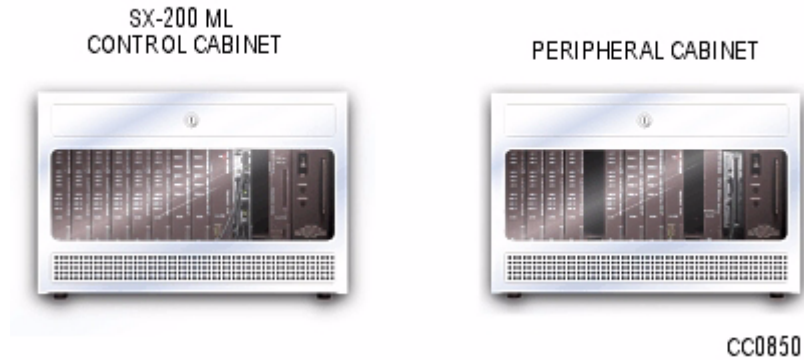

The SX-200 ML System has the following characteristics:

- Main Control Card IIIML (MCCIIIML)
- Bay Control Card II or Bay Control Card III, Bay Power Supply Card, and a Control Dual FIM Carrier Card or a Control Triple CIM Card (if expanding beyond the single cabinet)
- ONS/CLASS Line card, LS/GS card, LS/CLASS Trunk card, Universal card, COV card, DID card, OPS card, DNIC card, PRI card, BRI card, and T1 card
- Maximum of 96 physical ports using a single cabinet
- Maximum of one peripheral cabinet, SPINE bay or ISDN bay
- Maximum of 192 physical ports with a peripheral bay
- Requires LIGHTWARE 17 or greater software

The one peripheral bay can be a SX-200 peripheral cabinet, SX-200 LIGHT peripheral cabinet, SPINE bay, or ISDN bay. The ISDN bay may be an ISDN Network Gateway or a PRI card. The PRI card fits into a main control cabinet.

PERIPHERAL BAYS



SX-200 PERIPHERAL CABINET



SX-200 IP NODE



SX-200 LIGHT PERIPHERAL CABINET



ISDN NETWORK GATEWAY



SPINE BAY

CC0851

SX-200 ELx Cabinet

The SX-200 EL and the SX-200 ML system use the same rack mount (RM) horizontal cabinet, the SX-200 ELx cabinet (PN 9109-600-002-NA), for the control cabinet and for the peripheral cabinet.

The horizontal cabinet can be mounted in a standard 19" rack, or they can be stacked. The cabinet is plastic and plexiglass. The door on the cabinet allows the system administrator to see the system status at a glance. The control cabinet and the peripheral bays are linked by fibre or copper cables.

Located on the rear of the SX-200 ELx cabinet are four 25 pin connectors (J1- J4 for the peripheral interface cards), three RJ-45 connectors (J5 and J6 for T1 trunks and J7 for a system fail transfer control port), a printer port, a grounding connector, a maintenance port, and two RS-232 connectors (J10 and J11 for the PRI maintenance).

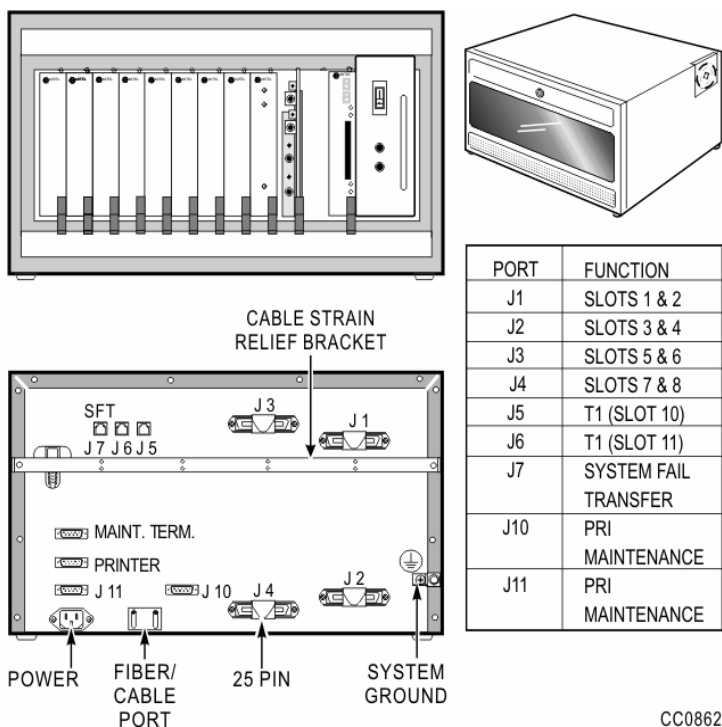

The SX-200 ELx cabinet supports 12 card slots: eight slots support line and trunk cards, and four support the control cards and the FIM or CIM carrier cards. The cabinet can be configured as the control cabinet or as a peripheral cabinet. The SX-200 EL system using a MCCIII ELx card requires the SX-200 ELx cabinet in order to accommodate the three links to each cabinet.

The system requires an SX-200 ELx cabinet to support any of the following cards or functionality:

- BCC III card
- PRI card
- BRI card
- CLASS functionality of the ONS/CLASS Line card
- SX-200 IP Node

SX-200 LIGHT Peripheral Cabinet

The SX-200 LIGHT Peripheral Cabinet is vertical as opposed to horizontal. The cabinet contains one Bay Power Supply, one Bay Control Card (with attached Peripheral FIM Carrier plus FIM), and up to eight peripheral interface cards. The SX-200 LIGHT Peripheral Cabinet is shown below.

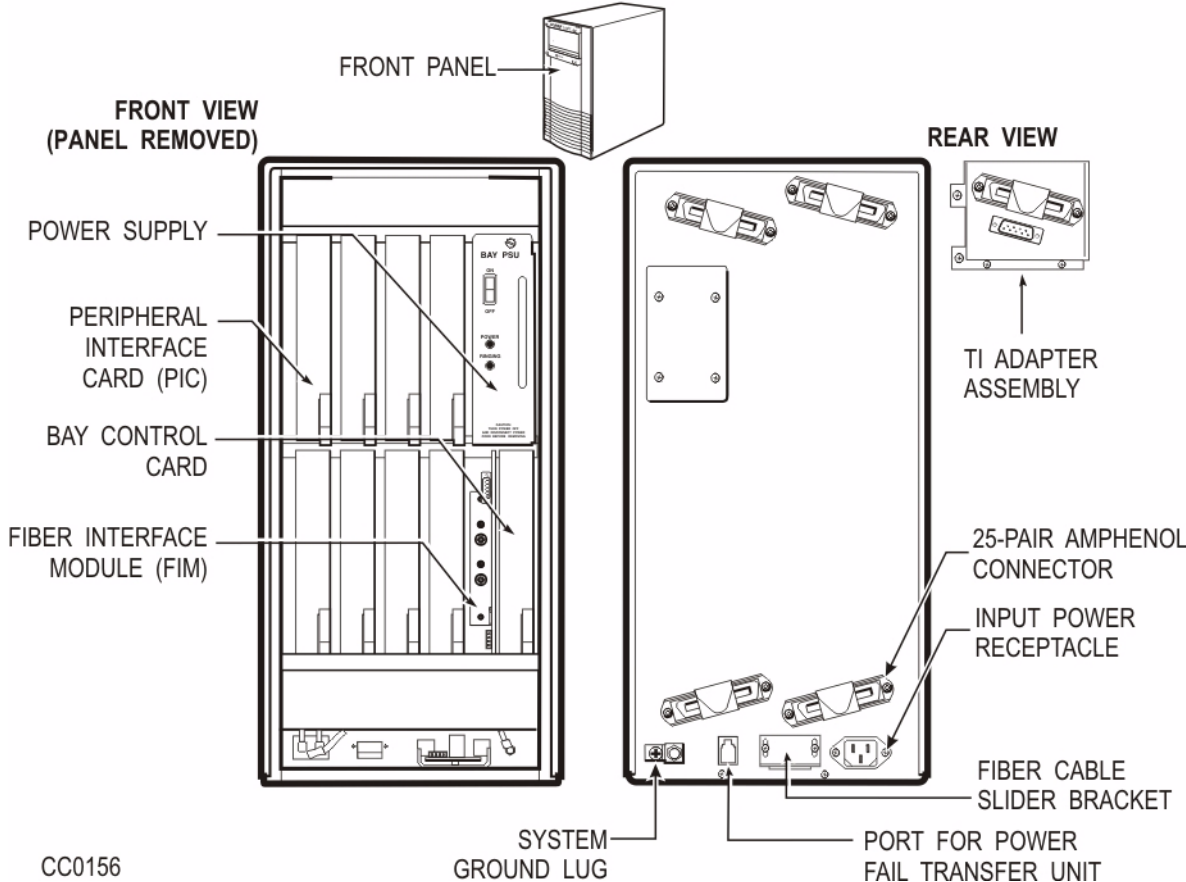

SX-200 SPINE Peripheral Bay

The SX-200 SPINE Peripheral Bay is available as a single (6 slot) or dual (12 slot) configuration. Each SPINE Peripheral Bay contains one Power Module, and up to six peripheral modules. The first SPINE Peripheral Bay (SPINE A) also contains a Control Module II (with FIM). There are limitations regarding the ONS modules. If there are three ONS modules installed in SPINE A, no other modules may be installed on that SPINE.

The SPINE Peripheral Bay can be located up to 1 km from the control node.

TYPICAL SX-200 SPINE PERIPHERAL BAY

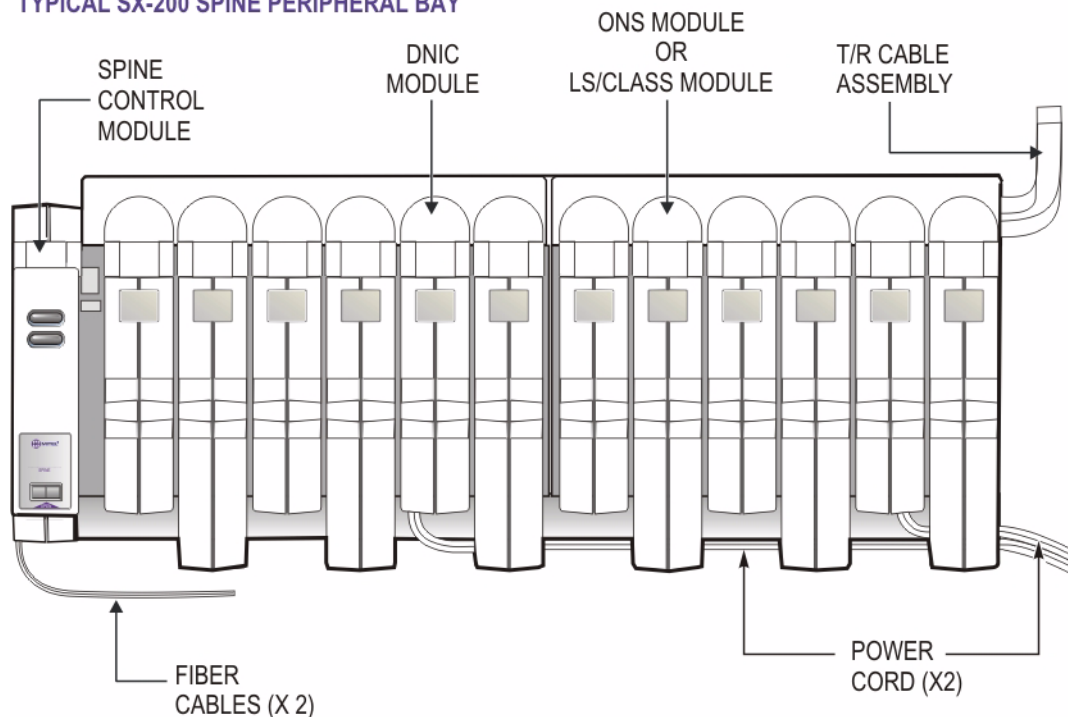

NOTE: MODULES MAY BE IN ANY SEQUENCE (EXCEPT ONS WHICH HAS QUANTITY RESTRICTIONS).

CC0269

SX-200 IP Node

The SX-200 IP Node brings Voice over IP (VoIP) capabilities to the SX-200 EL. The SX-200 IP Node addresses the LAN-based telephony requirements of small to medium enterprises and corporate enterprises with branch offices and teleworkers.

The SX-200 EL system supports up to 120 IP telephones. You can connect up to 60 IP phones to each SX-200 IP Node and up to two SX-200 IP Nodes per SX-200 EL system. Each SX-200 IP Node supports up to 24 IP phones with voice compression.

The SX-200 IP Node offers customers

- Reduced telecommunication costs and related support costs
- The flexibility of LAN-based telephony combined with the feature-rich, reliable and proven performance of the SX-200 EL
- Easy integration with existing circuit-switched telephony network and IP devices
- Fast installation of IP components in an existing SX-200 EL system
- The same easy-to-use functionality delivered by Mitel Networks DNIC phones
- An easy path for migrating your business communications to LAN-based telephony.

Your business can now gain these benefits and many others offered by the robust performance of an Internet-enabled SX-200 EL.

The SX-200 IP Node requires the following SX-200 system hardware:

- An SX-200 ELx Controller, page 8
- One or two Control Triple CIM Cards
- One Bay Control Card III for each SX-200 system.

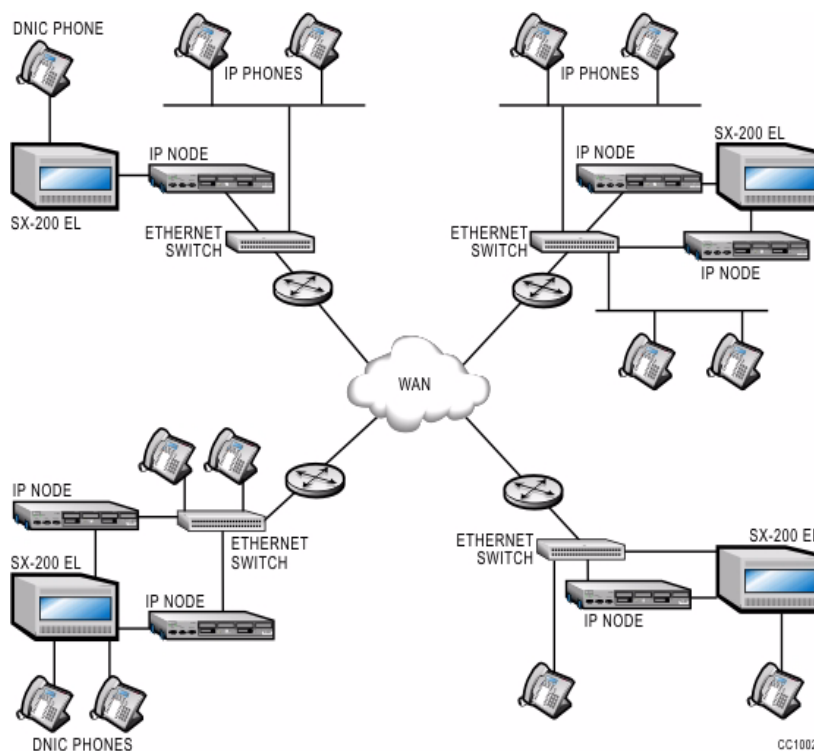

SX-200 EL/ML Peripheral Devices

The SX-200 EL and the SX-200 ML offer a wide range of peripheral devices to meet the voice and data switching needs of virtually all small to medium enterprises. The SX-200 EL now offers Voice over IP functionality and adds new IP phones and conference units to its long list of supported peripherals. Both the SX-200 ML and the SX-200 EL continue to support the highly successful SUPERSET line of telephones.

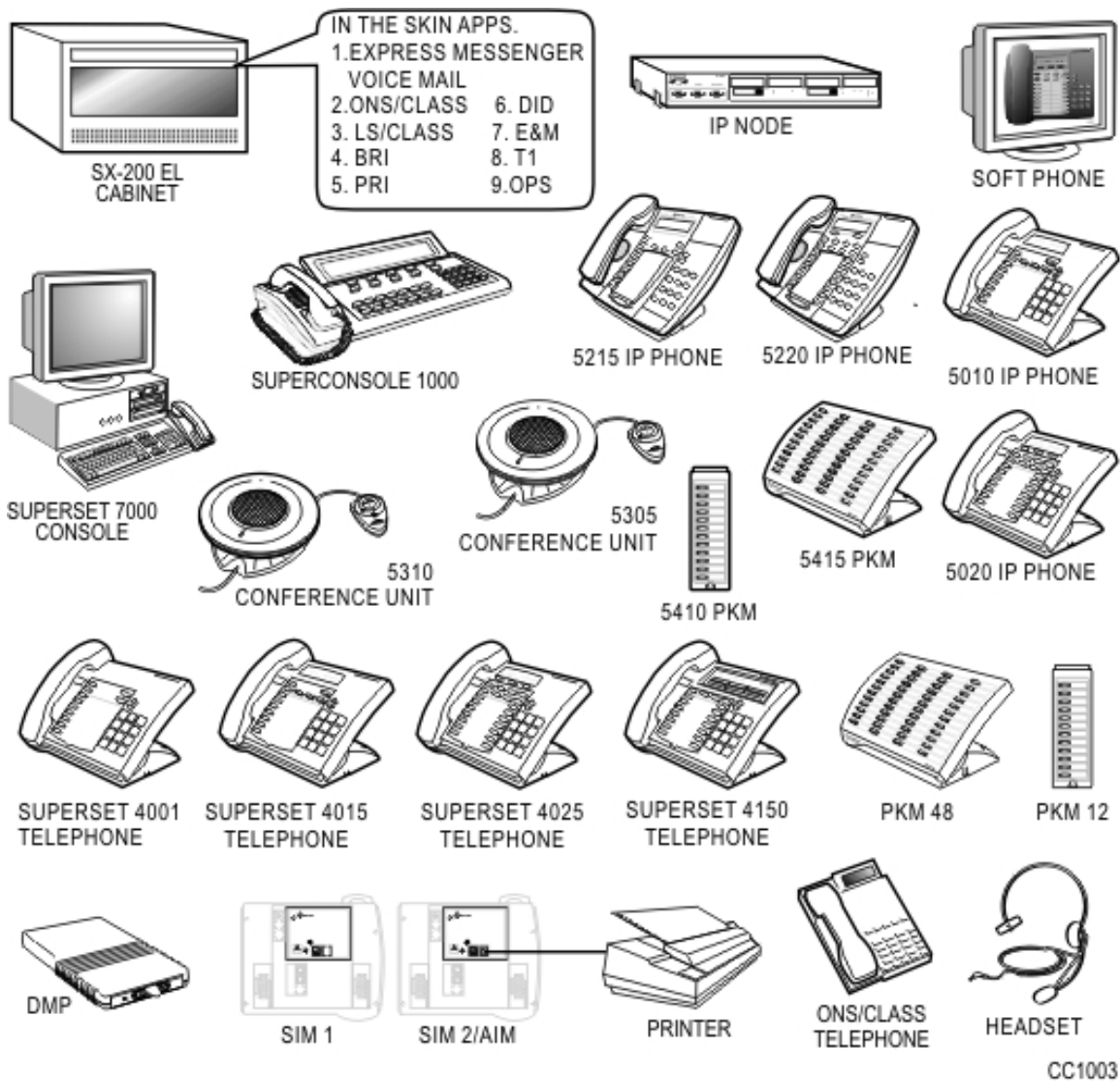

Voice Capabilities

The SX-200 EL interfaces to analog, digital, and IP peripheral devices. The SX-200 ML system interfaces to analog and digital peripheral devices. Peripheral devices for voice communications include, but are not limited to, the following sets.

IP Peripherals (SX-200 EL only):

Mitel Networks 5010 IP Phone: The Mitel Networks 5010 IP phone is a multi-line IP telephone. In addition to its 10 fixed function keys, the 5010 IP phone has six keys that you can program as **Speed Call** keys, **Feature Access** keys, or **Line Appearances**. The set also has a **Message** key and a **Microphone** key, both with indicator lamps. On incoming calls, the message lamp flashes in cadence with ringing of the set.

Mitel Networks 5020 IP Phone: The Mitel Networks 5020 IP phone is a multi-line IP telephone. It has 14 programmable keys with associated LCD indicators. These keys can be programmed as **Speed Call** keys, **Feature Access** keys, or **Line Appearances**. One key must be reserved for the prime line. Above the 14 programmable keys are a 2x20 alphanumeric bitmap graphics display and three softkeys. The display comes with or without backlighting. The three softkeys allow set users to select command prompts that appear in the display. The set also has a **Message** key and a **Microphone** key, both with indicator lamps, and eight fixed function keys without indicator lamps. On incoming calls, the message lamp flashes in cadence with ringing of the set. The 5020 IP phone offers half-duplex functionality with the speaker phone.

Mitel Networks 5215 IP Phone: The Mitel Networks 5215 IP phone is a multi-line IP phone. In addition to its 10 fixed function keys, the 5215 IP phone has six keys that can be programmed as **Speed Call** keys, **Feature Access** keys, or **Line Appearances**. The set also has a **Message** key and a **Microphone** key, both with indicator lamps. On incoming calls, the message lamp flashes in cadence with ringing of the set.

Mitel Networks 5220 IP Phone: The Mitel Networks 5220 IP phone is a multi-line IP phone. It has 14 programmable keys with associated LCD indicators. These keys can be programmed as **Speed Call** keys, **Feature Access** keys, or **Line Appearances**. One key must be reserved for the prime line. The three softkeys allow set users to select command prompts that appear in the display. The set also has a **Message** key and a **Microphone** key, both with indicator lamps, and eight fixed function keys without indicator lamps. On incoming calls, the message lamp flashes in cadence with ringing of the set. The 5220 IP phone offers half-duplex functionality with the speaker phone.

Mitel Networks 5305 IP Office Conference Unit: The Mitel Networks 5305 IP Office Conference Unit is a high-quality conference unit that uses acoustic beam-forming technology to ensure superior performance. The unit is used with the 5020 IP Phone and connects to the phone's headset port. This unit is designed for optimal performance in a private office that measures 12 feet by 15 feet (3.6 meters by 4.5 meters). The 5305 IP Conference Unit package includes a speaker unit and a side control unit. An optional mouse controller is available.

Mitel Networks 5310 IP Board Room Conference Unit: The Mitel Networks 5310 IP Board Room Conference Unit is a high-quality conference unit that uses acoustic beam-forming technology to ensure superior performance. The unit is used with the 5020 IP Phone and

connects to the phone's headset port. This unit is designed for optimal performance in a room that measures 15 feet by 25 feet (4.5 meters by 7.6 meters). The 5310 IP Conference Unit package includes a 5020 IP Phone, a speaker unit, and a side control unit. An optional mouse controller is available.

Mitel Networks 5410 Programmable Key Module: The Mitel Networks 5410 Programmable Key Module (PKM) provides 12 additional personal keys for a 5020 IP Phone. They can be programmed as **Feature** keys, **Speed Call** keys, **Direct Station Select** keys, or as **Line Appearance** keys. Each key has a Line Status Indicator that works the same way as those on the associated phone. The 5410 PKM unit connects to a 5020 IP Phone by using a Mitel Networks PKM Interface Module (IM). The PKM IM is installed separately at the base of phone and is only compatible with 5020 IP Phones.

Mitel Networks 5415 Programmable Key Module: The Mitel Networks 5415 Programmable Key Module provides 48 additional feature keys for a 5020 IP Phone. They can be programmed as **Feature** keys, **Speed Call** keys, **Direct Station Select** keys, or as **Line Appearance** keys. Each key has a Line Status Indicator that works the same way as those on the associated phone. The keys can be programmed through the phone. The 5415 PKM unit connects to a 5020 IP Phone by using a Mitel Networks PKM IM. The PKM IM is installed separately at the base of phone and is only compatible with 5020 IP Phones. A 5020 IP phone can support a maximum of two 5415 PKMs, which together provide a total of 96 additional feature keys.

Standard Telephones:

Industry-standard rotary dial and DTMF telephones are supported; ONS and OPS lines provide an interface to the bay for these sets. The rotary telephone is not supported on the SX-200 SPINE.

SUPERSET 4001 Telephone: The SUPERSET 4001 telephone is a single-line digital telephone. It has a Flash key, a Message key, a Hold/Retrieve key, seven Speed Dial keys, a hold lamp, and a message indicator lamp, as well as keys for adjusting the ringer and handset receiver volume. On incoming calls, the message lamp flashes in cadence with ringing of the set.

SUPERSET 4015 Telephone: The SUPERSET 4015 telephone is a multi-line digital telephone. In addition to its 10 fixed function keys, the SUPERSET 4015 has six keys that can be programmed as Speed Call keys, Feature Access keys or Line Appearances. The set also has a Message key and Microphone key with indicator lamps. On incoming calls, the message lamp flashes in cadence with ringing of the set.

SUPERSET 4025 Telephone: The SUPERSET 4025 is a multi-line digital telephone. It has 14 programmable keys with associated LCD indicators. These keys can be programmed as Speed Call keys, Feature Access keys or Line Appearances. One key must be reserved for the prime line. Above the 14 programmable keys are a 2x20 alphanumeric bitmap graphics display and three softkeys. The display comes with backlighting or without backlighting. The three softkeys allow set users to select command prompts that appear in the display. The set also has a Message key and Microphone key with indicator lamps, and eight fixed function keys without indicator lamps. On incoming calls, the message lamp flashes in cadence with ringing of the set. The SUPERSET 4125 offers half-duplex functionality with the speaker phone.

SUPERSET 4090 Telephone: The SUPERSET 4090 telephone is a digital cordless telephone equipped with a backup battery charging system and an extra battery. A belt clip and a wall-mounting adapter are also included. The SUPERSET 4090 cordless may be used with another 4000 Series set. You can set up Call Forward on the desk phone to send calls to the SUPERSET 4090 when you are away from your desk. You can also use a line appearance key on the SUPERSET 4090 to answer calls to the Prime Line on your desk phone.

SUPERSET 4125 Telephone: The SUPERSET 4125 telephone is similar to the SUPERSET 4025 telephone. The difference between the two is that the SUPERSET 4125 can be connected to a PC. The SUPERSET 4125 has a built-in RS-232 serial port to accommodate the connection to a PC serial port.

The SUPERSET 4125 telephone, like the SUPERSET 4025 telephone, has 14 programmable keys with associated LCD indicators. These keys can be programmed as Speed Call keys, Feature Access keys or Line Appearances. Above the 14 programmable keys are a backlit, 2x20 alphanumeric bitmap graphics display and three softkeys. The three softkeys allow set users to select command prompts that appear in the display. The set also has a **Message** key and **Microphone** key with indicator lamps, and eight fixed function keys without indicator lamps. On incoming calls, the message lamp flashes in cadence with ringing of the set. The set also has a headset jack that allows the user to have a headset and handset plugged in at the same time. The SUPERSET 4125 offers half-duplex functionality with the speaker phone.

SUPERSET 4150 Telephone: The SUPERSET 4150 telephone is a multi-line digital telephone that provides advanced telephony features and connectivity to a computer. A built-in RS-232 serial port accommodates the connection to a PC serial port. The SUPERSET 4150 has 14 keys that can be programmed as Speed Call keys or Line Appearances. One key must be reserved for the prime line. A backlit, alphanumeric display with six touch-sensitive softkey areas allows users to select call handling features easily. On incoming calls, the message lamp flashes in cadence with ringing of the set. The SUPERSET 4150 also offers full-duplex speaker functionality when the power adapter is connected to the set.

Note: The SUPERSET 400 series telephones have been discontinued, however they are still supported by the SX-200 system.

Attendant Console: The system supports three types of Attendant consoles; the LCD Console, the SUPERCONSOLE 1000® Attendant Console, and the SUPERSET 7000 Attendant Console. The LCD Console interfaces to a console module on the Universal Card, while the SUPERCONSOLE 1000 and SUPERSET 7000 Attendant consoles interface by one pair wiring to a DNIC circuit on a Digital Line Card.

Programmable Key Modules: Two types of Programmable Key Modules are available: the Mitel Networks Programmable Key Module 12 (PKM 12) and the Mitel Networks Programmable Key Module 48 (PKM 48). The PKM 12 provides 12 additional keys and line status displays to SUPERSET 4025, SUPERSET 4125, or SUPERSET 4150 telephones. Only one PKM 12 can be attached to the telephone. The PKM 48 provides 48 additional keys and line status displays to an attendant console or to SUPERSET 4025, SUPERSET 4125, or SUPERSET 4150 telephones. Up to two PKM 48 devices may be attached to the telephone or to an attendant console. Flash rates for the indicators are the same as on its associated telephone.

Notes:

1. The SUPERSET PKM has been discontinued but is still supported on the SX-200 system. This PKM provided 30 additional keys and line status displays to a SUPERSET 410, SUPERSET 420, or SUPERSET 430 telephone. Up to three PKMs could be attached to a telephone.
2. The SUPERSET DSS Module has also been discontinued but is still supported. This module provided a 32-position Busy Lamp Field and a 32-key direct station select keypad for the associated SUPERSET telephone.

Interface Modules: Two types of interface modules are available. SUPERSET Interface Module 1 (SIM1) interfaces a PKM 12 or up to two PKM 48 devices with a SUPERSET 4025, SUPERSET 4125, or SUPERSET 4150 telephone. SUPERSET Interface Module 2 (SIM2) interfaces a SUPERSET 4025, SUPERSET 4125, or SUPERSET 4150 telephone with a PKM 12 or up to two PKM 48 devices and an analog device, such as a telephone set, modem, or FAX machine. Both interface modules are installed in the base of a SUPERSET 4025, SUPERSET 4125, or SUPERSET 4150 telephone.

Direct Station Select/Busy Lamp Field (DSS/BLF) Interface Unit: This unit interfaces up to two programmable key modules (PKM 48 devices) with an attendant console. Each PKM 48 provides the attendant console user with 48 DSS/BLF keys. Note that the SUPERCONSOLE 1000 with the back-lit display does not require this interface unit.

DNIC Music-on-Hold/Paging Unit: The DNIC Music-on-Hold/Paging Unit (DMP) can be wall-mounted next to the PBX. It is powered by the system, and does not require a separate power source. A single 25 pair amphenol connects to the PBX via the main distribution frame. A single LED indicator provides basic status information. The DMP interfaces a standard DNIC port to the following external equipment:

- External music source for Music-on-Hold
- External paging amplifier (with or without answerback capability)
- Up to two night bells
- An external alarm.

Voice Mail Products: The NuPoint Messenger™ voice processor works in conjunction with your telephone to provide an effective and efficient communications tool. With it, you can use any multi-tone telephone to send and receive recorded messages at any time, anywhere in the world. In the office, NuPoint Messenger makes sure you don't miss calls. Your telephone is always answered with your personal message, even if you aren't available. You have the option of asking callers to leave a message, or giving them the name of someone else to contact.

The Mitel Networks 6500 Speech Enabled Applications is a PC based, speech recognition application that allows SUPERSET 420, SUPERSET 430, SUPERSET 4025, SUPERSET 4125, and SUPERSET 4150 telephone users to place a call to a specific person or department based on spoken commands or use speech to listen to and manage their messages, appointments, meetings, and tasks within Microsoft Outlook.

The Mitel Express Messenger voice mail card allows an SX-200 EL or the SX-200 ML system to have a single card voice mail facility. This card allows a single voice mail card to provide either two, four, six, or eight voice mail ports to an SX-200 EL or an SX-200 ML system that has LIGHTWARE 16 Release 1.1 software or later. Softkey and Hospitality support is offered with LIGHTWARE 17 Release 3.1 and greater and Mitel Express Messenger Version 2.1 and greater.

Express Messenger supports up to 249 mailboxes and provides 33 hours of message file storage. After a call is forwarded to voice mail from an extension, the caller's calling line identification (CLID) and the forwarding extension number are passed to the Express Messenger system. The Express Messenger offers

- Auto attendant
- Paging
- Record a Call
- Multiple Languages
- Secure personal mailboxes
- Broadcast message distribution
- Temporary greetings
- Unlimited message length
- Directory/name dialing
- Operating revert.

Data Capabilities

Datasets provide data facilities for terminals, digital SUPERSET telephones, and other types of data circuits. The DATASET 1100 series support asynchronous data communications at rates up to 19.2 kbps and interface with the system through a Digital Line Card or a DNIC Module. The DATASET 2100 series support asynchronous and synchronous data communications at rates up to 19.2 kbps and interface with the system through a Digital Line Card or a DNIC Module.

MILINK Data Module: The MILINK Data Module is connected to a modular jack located on the base of SUPERSET 410, SUPERSET 420, or SUPERSET 430 telephones, and is used to interface a terminal, personal computer, or other peripheral device to a host computer. The MILINK Data Module interfaces to the system through the same pair of wires that the telephone set voice circuit uses. The MILINK Data module is discontinued but is still supported with the SX-200 system.

DATASET 1101 Cartridge: A DATASET 1101 Cartridge is mounted within a SUPERSET 3DN or a SUPERSET 4DN telephone set. The cartridge is connected via an internal cable to the telephone set circuit and is used to interface a terminal, personal computer, or other peripheral device to a host computer. It interfaces to the system Digital Line Card through the same pair of wires that the telephone set voice circuit uses.

DATASET 1103 Standalone: The DATASET 1103 Standalone is packaged in a flat case which can be placed under a standard desk telephone set. The DATASET 1103 Cartridge usually interfaces a terminal, a personal computer, a printer, a file disk, or another peripheral device to the system, for connection to a host computer or to another peripheral device.

DATASET 2103 Standalone: The DATASET 2103 Standalone is a Synchronous/Asynchronous data set which is used with Mitel Networks PBXs to interface peripheral devices to the system. It is packaged in a flat case which can be placed under a standard desk telephone set. The DATASET 2103 Standalone connects to a DNIC circuit within the PBX by a single twisted pair (the telephone set is connected independently).

Terminals and Printers: A VT100™ compatible terminal or personal computer with VT100 terminal emulation software can be connected to the system as a maintenance terminal. Printers are used to create hard-copy records such as traffic reports, maintenance information, etc.

Supporting Applications

In the SX-200 EL and the SX-200 ML system, groups of features have been combined into applications designed to meet the specialized needs of small to medium size enterprises. Applications can simplify call handling and control communication costs in business, commercial and institutional environments, simplify hotel/motel operation, enhance any telephone sales activity, and provide a cost-effective way for small organizations to access advanced business features.

Voice over IP (VoIP)

With the introduction of the Mitel Networks SX-200 IP Node, the SX-200 EL now brings the cost-saving benefits of Voice over IP (VoIP) to small to medium enterprises and corporate enterprises with remote offices and teleworkers. The SX-200 IP Node supports up to 60 IP phones per IP Node and up to 120 IP phones per SX-200 EL system. Each SX-200 IP Node supports up to 24 IP phones with voice compression.

Business/Commercial/Institutional

The SX-200 EL and the SX-200 ML system business features, such as uniform call distribution and verified account codes, enhance your communications capability. They offer your organization flexible office configurations, control of your personnel's telephone privileges, control of communication costs, and traffic measurement reports.

On an individual basis, they offer your employees personalized call management capabilities - campon, speed calling, messaging, conferencing, and callback to a line that is busy or doesn't answer.

Key system functionality is provided for those companies or divisions that are interested in having a departmental key system application within their system environment.

Hotel/Motel

The Hotel/Motel application is a purchasable option.

Hotel/Motel features speed up guest check in and check out, and allow you to manage your rooms efficiently, wake up guests on request, control guest telephone privileges, recover the cost of guest calls (SMDR supported), and notify guests of their messages. These functions are all handled by the Attendant or front desk clerk using the SUPERCONSOLE 1000® Attendant Console or the Front Desk Terminal.

The Front Desk Terminal interfaces to the SX-200 EL and SX-200 ML systems through an 1100-Series DATASET. If efficient billing is in place the Front Desk Terminal provides a low-cost alternative to a Property Management System (PMS) for smaller Hotel/Motel operators (in the 40 - 90 room size). It is ideal for fast check in and out, guest location, and house keeping functions.

For computerized control and monitoring of Hotel/Motel functions, the system can interface to a property management system (PMS).

Hotel/Motel and Front Desk Terminal functions are mutually exclusive with Property Management System (PMS).

Assisted Living

Mitel Networks 6451 Intelligent Dispatch is a PC software application that provides the ideal alarm messaging system for Assisted Living Centers with less than 250 rooms. The messaging system sends telephone, pull cord, and door alarms from extended care residents to wired/wireless telephones or pagers of the nurses/caregiver.

The nurses/caregivers can

- Provide immediate care 24-hours a day

The management can

- Provide a discrete alarm system
- Provide alarm logs
- Ensure constant supervision
- Increase staff efficiency

Mitel Networks 6451 Intelligent Dispatch ensures a superior alarm system by using Guardian; a safety net for the alarm messaging system. Guardian provides a constant watch and flags any malfunctions in the system and in the devices being monitored.

Mitel Networks 6451 Intelligent Dispatch supports the following alarm types:

- Telephone Timer Alarm
 - The Telephone Timer alarm generates when the telephone of the resident is in the following states:
 - Off-hook and nothing dialed in a specified time period
 - Off-hook, incomplete dialing, and idle for a specified time period
 - On hold for a specified time period
 - Abnormal states (re-order tone) for a specified time period.
 - The Telephone Timer alarm does not generate if the telephone is in a connected state or if the telephone is on-hook.
- Emergency 911 Alarm
 - The Emergency 911 alarm generates when a resident or an attendant dials 911. This alarm notifies staff of an emergency, so the appropriate actions can take place.
- Assistance Required Alarm (pull cords)
 - The Assistance Required alarm generates when a pull cord is pulled. This alarm will remain active until the pull cord is put back to its normal state.

- Door Alarm
 - The Door alarm generates when a monitored door opens. The monitored doors have two-wired contact sensors; one on the frame and one on the movable door. When the door opens, the sensor contact is lost and the sensor generates an alarm. The alarm goes off when the door opens and remains active until the attendant takes responsibility for the alarm and closes the door. If the door is opened and closed immediately, the alarm will remain active until an attendant takes responsibility for the alarm.

Call Management

The SX-200 EL and the SX-200 ML systems are designed to meet the needs of customers with special call management requirements. The system has the flexibility to accommodate users needing a large number of account codes or abbreviated dialing numbers, as well as those who wish to control communications costs by connecting to a private network or alternate common carrier. Three of the major call management facilities are outlined below.

Dynamic Memory Allocation: For maximum flexibility, the SX-200 EL and the SX-200 ML systems allocate memory only as required to features such as ARS, Toll Control, Verified Account Codes, and Abbreviated Dialing. This avoids the problems associated with allocating fixed blocks of memory to a particular feature.

Universal Digit Handling: Universal Digit Handling gives the SX-200 EL and SX-200 ML systems flexibility in processing dialed digits. It can handle any string from one to 26 digits long. This accommodates both North American and International numbering plans. It also allows access to alternative common carriers.

Internal telephone numbers can be one to five digits long, and conflicts are allowed. For example, extension 123 conflicts with extension 1234. The system can differentiate between conflicting extension numbers. Conflicts could slow down system performance.

Dial-in trunks can have up to two prefix digits to allow for setup of seven-digit private networks and flexible handling of incoming calls.

Automatic Route Selection and Toll Control: Automatic Route Selection (ARS) and Toll Control are integrated features. Long-distance checks are completed before the system selects a trunk. Illegal calls are stopped as soon as they are recognized, and allowed calls, select a trunk group as soon as the route is known. To prevent long delays, dialing on the trunk can start while you are dialing.

- Universal Digit Handling, ARS and Toll Control can handle any dialed string from one to 26 digits.

ACD TELEMARKETER® Application

The ACD TELEMARKETER application is a purchasable option.

The ACD TELEMARKETER application is an advanced Automatic Call Distribution (ACD) system that is fully integrated with the SX-200 EL/ML systems, and designed with the power and performance needed to ensure satisfaction in the most demanding call center environments. For maximum efficiency, all ACD personnel use SUPERSET 4015, SUPERSET 4025, SUPERSET 4125, SUPERSET 420, and SUPERSET 410 telephones programmed with special displays and softkeys. With LIGHTWARE 17 Release 3.0 and greater software, the ACD personnel may also use the SUPERSET 4150 and SUPERSET 430. The displays provide call status and progress messages; the softkeys give single button selection of ACD features.

The heart of the ACD TELEMARKETER feature is the ACD PATH, an innovative call routing design that guides incoming calls through the system. See ACD Path, page 132. The ACD TELEMARKETER feature also uses predictive overflow to keep call queuing time to a minimum. See Predictive Overflow, page 133.

The ACD TELEMARKETER feature includes real-time displays via standard asynchronous datasets and ASCII terminals. Thirteen displays encompass every area of the ACD operation.

The purchasable option, Maximum ACD Agents, enables the maximum number of ACD agents that can be logged in concurrently. This maximum number is from 0 through 100, in increments of 5.

Complementing the ACD TELEMARKETER application is a reporting system offered by Mitel Networks 6100 Contact Center Solutions . The purchasable option, ACD Real Time Event, enables the system together with Mitel Networks 6100 Contact Center Solutions on a host computer, to monitor and record the activity of the ACD operation in real time.

Automated Attendant

The automated attendant application is a purchasable option.

Automated attendant features connect incoming calls from a DTMF telephone to a recording. The recording instructs the caller to dial one or more digits to be routed to a specific answering point, such as sales, service, parts, or general office. Once a digit is dialed, the system can add prefix digits in front of the dialed digit to provide a valid extension number, a hunt group number, a system abbreviated dial number, or a feature access code. If a digit is not dialed (or cannot be dialed because the incoming telephone is not DTMF) the incoming caller is routed to a default answering point at the completion of the message.

The automated attendant feature supports the FAX tone detection feature. Both of these features are optional and must be purchased.

MITEL MyAttendant

MITEL MyAttendant is a software application that provides a call answering position for a multi-tenant environment or for a general business with multiple departments and mobile workers. This PC application allows the user to work on other PC applications when there are no incoming calls and when there are calls, allows the PC user to effectively manage calls for multiple clients.

MITEL MyAttendant

- Provides a Message Board where messages are typed, saved, printed or emailed to the employee
- Allows the programming of customized greetings for different incoming trunks
- Lists employees associated with each incoming LDN to allow easy transferring
- Shows specific transfer information; e.g., cell phones, extensions, or pager numbers for each employee

MITEL MyAttendant on a PC can be used in conjunction with other PCs with MITEL MyAttendant to allow a group of attendants to work as a team. Information such as the client database, and information about calls waiting in the queue is shared via a local area network.

The MITEL MyAttendant system consists of a system unit (PC), monitor, keyboard, TALK TO[®] CX card, a handset, and optionally a local area network.

The purchased package includes a MITEL MyAttendant Installation Disc, a TALK TO CX card, a handset and cradle, and keyboard stickers. Documentation is provided on the MITEL MyAttendant Installation Disc.

You can use a headset instead of the handset. The headsets that are qualified for use with MITEL MyAttendant are the Monaural Overhead Headset PN 9132-800-500-NA and the Binaural Overhead Headset PN 50000606.

MITEL MyAttendant requires LIGHTWARE 17 Release 4.0 or greater.

FAX Tone Detection

The FAX tone detection application is a purchasable option.

FAX Tone Detection allows incoming FAX calls arriving on the Automated Attendant trunks to be automatically routed to a preprogrammed FAX machine. The Automated Attendant option must be enabled before enabling the FAX Tone Detection option.

Centralized Attendant

The Centralized Attendant application is a purchasable option.

The Centralized Attendant feature allows an attendant on one system to answer calls that arrive at another interconnected system. The call arrives at the attendant via a dedicated Release Link Trunk (RLT), which can be T1 E&M, T1 E&M DISA, E&M, or E&M DISA. When the attendant releases a call to its destination, the RLT is released.

Centralized Voice Mail

The Centralized Voice Mail application is a purchasable option

The Centralized Voice Mail feature allows a single voice mail device to service several interconnected PBXs with LIGHTWARE 17 and greater software.

Tenanting

Economy of scale makes sharing system services practical. Using the tenanting features, up to 25 small businesses, or departments of a larger business, can share the services of an SX-200 EL or SX-200 ML system. Logically, the system can be divided into up to 25 separate PBXs, each providing its tenant with customized features and services.

Consoles, night bells, Music-on-Hold, CO trunks, and dial-in trunks can either be shared between tenants or allocated individually to each tenant. Switching to night service can be done centrally, or by an individual tenant. Calls through the system can be blocked, so tenants can only call each other on CO trunks. Unanswered or after-hours calls can be answered by a "landlord" console.

Tenants can gain additional flexibility by using SUPERSET display telephones as subattendant positions. The main console position could be handled by these telephones, using line buttons to receive tenant recalls.

Data calls may be assigned to separate tenants, as required, to control access to data devices.

MITEL Application Interface (MAI) Package

The MITEL Application Interface (MAI) package is a purchasable option.

The MITEL Application Interface (MAI) software package allows MITEL computer-based applications to access the system features. MAI is used in conjunction with an external host computer connected via an RS-232 link to a DATASET 2100 device. The DATASET device is connected to a DNIC port on the system via a single twisted pair.

Data Switching

The family of datasets meets customers' expanding data-switching needs by integrating voice and data in the SX-200 EL or SX-200 ML systems. Datasets provide access to data switching in ASCII format for all types of synchronous and asynchronous data devices.

Data switching is transparent to the system. When data is switched through the system its data format and protocol are unchanged.

For switching data over longer distances, modems can be connected to the system. Modems can be associated with Datasets in a modem pool hunt group for improved access to the system.

NuPoint Messenger

NuPoint Messenger voice mail is an optional service. This powerful PC-based voice processing system, provides call processing, voice and fax messaging, as well as paging support.

With NuPoint Messenger, you can send and receive voice, fax, and compound voice and fax messages at any hour of the day from any multi-tone telephone in the world. You can call the system and access your messages quickly and easily by following the prompts. Fax and voice messages are sent and received from your personal "mailbox". This give you access to information remotely, and assures you of secure access to your documents. You determine when and where you want your fax messages delivered.

The caller is given the choice of recording a message, speaking to someone else, or requesting personal assistance. When someone has left a message for you, NuPoint Messenger can notify you in a variety of ways:

- Message Delivery allows you to define a schedule so that if a message arrives in your mailbox, NuPoint Messenger will call you at a specific telephone number at a specific time so that you can retrieve the message
- Paging allows you to define a schedule so that when a message arrives in your mailbox, NuPoint Messenger notifies your pager.

Mitel Express Messenger

Mitel Express Messenger is an automated voice mail system for handling telephone calls and taking messages; it is designed specifically for operation with your telephone. Express messenger provides you with a mailbox for sending and receiving messages, which you can personalize with your name, a greeting, and a private passcode.

Mitel Express Messenger provides notification of messages to pagers or other telephones and includes an Automated Attendant which is able to detect and forward incoming FAX calls.

Mitel Express Messenger provides up to eight voice mail ports to a SX-200 ML or SX-200 EL system that has LIGHTWARE 16 Release 1.1 or later software. More than one Express Messenger may be installed in a system; however, each Express Messenger will operate independently. For example, multiple Express Messenger systems could be installed to provide voice mail support to several tenants. Express Messenger typically supports 10 to 25 users per port, depending on the usage of Express Messenger.

MITEL TAPI Desktop Software

The MITEL TAPI (Telephony Application Programming Interface) Desktop software provides communication between the PC and the telephone. The users can activate management functions on first-party calls (e.g. dial, answer, hold, forward) from their PC.

The MITEL TAPI Desktop software enables the communication between the SX-200 system and the PC via an RS-232 cable on a SUPERSET 4150 or SUPERSET 4125 telephone. The

SUPERSET 4150 and the SUPERSET 4125 telephone are sold packaged with the MITEL TAPI Desktop software on a CD, an AC power adapter, and an RS-232 cable.

A MOSS password enables the feature, TAPI Support Over DNIC. This purchasable system option enables a maximum number of TAPI desktops. The option is sold in increments of 5 TAPI desktops and the maximum number available is 50 per system. Recommended configurations suggest a maximum of 24 sets per bay and a maximum of 3 sets per DNIC card.

Mitel Networks 6100 Contact Center Solutions

Mitel Networks 6100 Contact Center Solutions (6100 CCS) include automated call distribution, interactive voice response, computer-telephony integration, real-time workforce management, intelligent in-queue messaging, email, web chat, fax routing and queuing, and comprehensive reporting capabilities. The 6100 CCS product has a suite of applications that enable customers to maximize the efficiency of their call center.

The 6100 CCS product incorporates

- Mitel Networks 6110 Contact Center Management
- Mitel Networks 6115 Interactive Contact Center
- Mitel Networks 6120 Contact Center Scheduling
- Mitel Networks 6150 Multimedia Contact Center
- Mitel Networks 6160 Intelligent Queue.

Mitel Networks 6110 Contact Center Management is an application that manages ACD information. The application uses a familiar Microsoft Excel and Microsoft Internet Explorer interface. Call Center managers can log on to any PC to run reports, monitor real time activities, forecast the number of agents required, and perform numerous management functions over the network.

Mitel Networks 6115 Interactive Contact Center enables supervisors to alter the way calls are handled in the call center.

Mitel Networks 6120 Contact Center Scheduling works in conjunction with the Mitel Networks 6110 Contact Center Management application to optimize staffing levels to match business needs.

Mitel Networks 6150 Multimedia Contact Center works with Microsoft Exchange and Outlook to provide Contact Centers with automatic e-mail distribution. E-mails are sent to one address, and the application manages the distribution based on agent availability and skill level. The process is similar to the way that Automatic Call Distribution works for telephone calls.

Mitel Networks 6160 Intelligent Queue enhances Mitel Networks 6110 Contact Center Management. 6160 IQ is an intelligent recorded announcement device (RAD) that allows call centers to customize which messages callers will hear based on the time, date, and/or number of callers in the queue. The application is managed through a web-based interface with .WAV file recordings.

Mitel Networks 6500 Speech-Enabled Applications

Mitel Networks 6500 Speech-Enabled Applications is a PC based, speech recognition application that routes incoming calls to a specific person or department based on spoken commands. Typically, you state the name of the person that you want to speak to and the system routes your call to the requested party.

The 6500 SE Applications have two systems: 6500 SE Attendant and the 6500 SE Unified Messaging.

The 6500 SE Attendant system has the following key features:

- Users can place a call to any number in the corporate directory by stating a name, extension, or department
- Internal users who have the required system privileges can call into the system from an external number and place a call to any number that is in the corporate directory by using speech
- Registered users can program their own directory list of frequently called numbers and then place calls to those numbers by using speech.

The 6500 SE Unified Messaging system has the following key features:

- Provides all the functionality of the 6500 SE Attendant plus allows users to access their email and voice mail messages in their inbox of Microsoft Outlook through spoken commands. Users can address messages by name and use voice commands to search or sort messages by sender or message type.
- With the Fax Integration software, users can use their telephone to identify incoming faxes in their inbox of Microsoft Outlook and forward the fax message to a fax machine of their choice.
- With the Calendar and Task Management software, users can use their telephone to manage their appointments, tasks, and meeting requests in Microsoft Outlook.

The 6500 SE Applications interface to the system via a number of DNIC ports. The auto attendant is available in two- to 24- port configurations in 2-port increments.

ISDN Support

The Integrated Services Digital Network (ISDN), transmitting voice, data and video at high speeds, accurately and without a modem, has revolutionised communications. ISDN services can be deployed and accessed at enterprise, department and desktop levels by its simple addition to your existing SX-200 network. ISDN proves its worth by its ability to carry voice, data and video imaging on one network.

ISDN standards define two types of ISDN interface. Basic rate interface (BRI) is defined as 2B+D: two 64 kbs B channels and one 16 kbs D channel. T1 ISDN Primary rate interface (PRI) is defined as 23B+D: 23 64 kbs B channels and one 16 kbs D channel. The B channels carry voice or data, and the D channel provides the signaling channel.

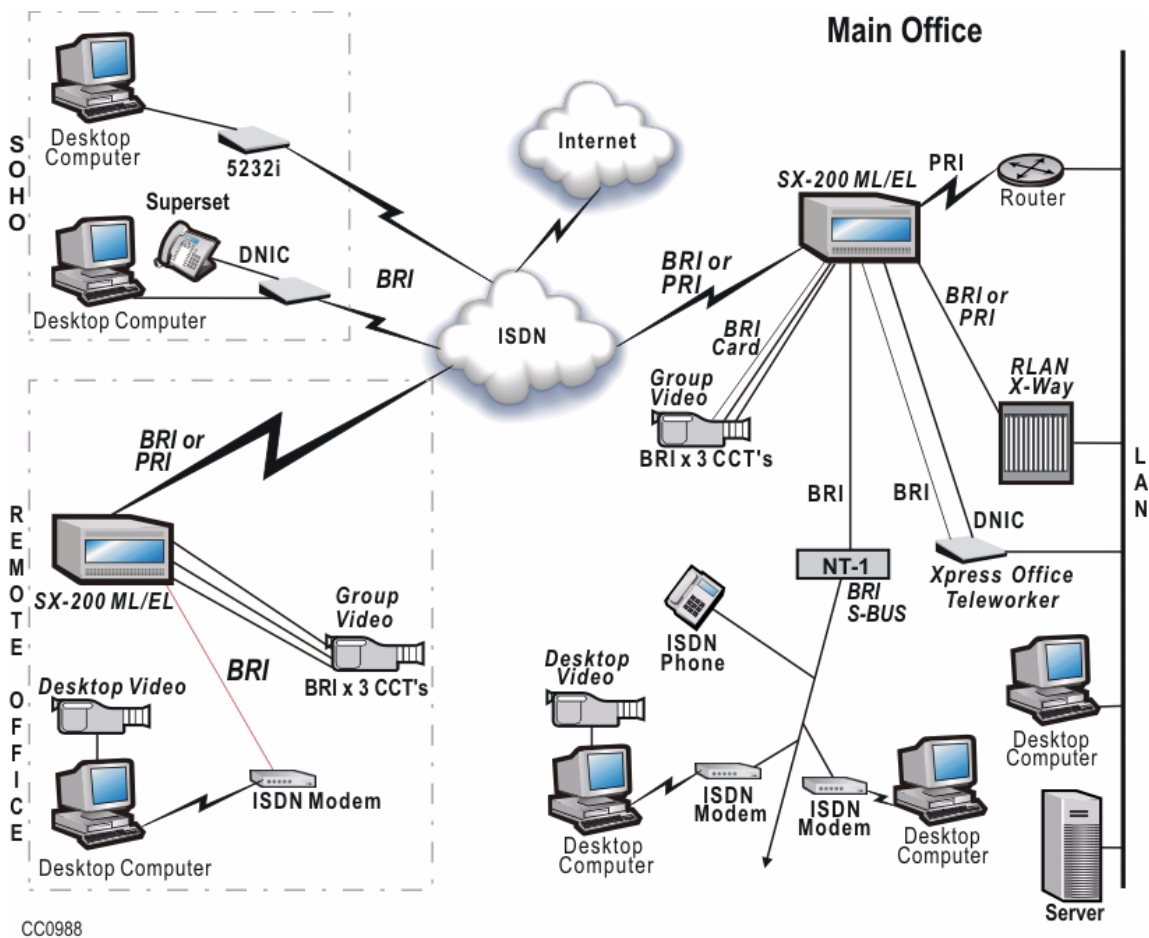

Basic Rate Interface Card

BRI is typically used for video conferencing and providing access to inexpensive digital trunking for small sites. BRI software supports National ISDN 1 (NI-1) and NI-2 basic call and incoming calling name delivery. On the trunk side, BRI software supports an access point for video conferencing and Group 4 fax. It also supports internet access for PC data terminals, and it can provide a voice alternative to analog lines for small systems. On the line side, BRI software supports the requirements for hosting a videoconference unit, a Group 4 fax unit, or a PC with a BRI interface. One common line-side BRI application is hosting an Xpress Office Teleworker (5232i) for remote DNIC operation either directly, or through a PRI channel.

The BRI card supports the following ISDN Services:

- **Calling Party Number (CPN)** - This number substitutes the calling station number on outgoing calls for purposes of network identification and call back.
- **Calling Name ID (CNID)** - This ID is the incoming call name delivery per NA DMS100 custom specification. This Calling Name feature is an option that must be enabled at the Central Office. The SX-200 only supports the inbound calling name.
- **Calling Line Identification Presentation (CLIP)** - The Calling Party Number can be provided to the ISDN Network for outgoing calls or provided to the BRI card from the ISDN Network for incoming calls. This information is passed onto the system and can be used for database applications such as screen pops and for inclusion in SMDR records.
- **Calling Line Identification Restriction (CLIR)** - This feature allows users to prevent their telephone number from being presented to the called party.

ISDN Primary Rate Interface Card

ISDN Primary Rate Interface (PRI) is becoming the most cost-effective solution for accessing enhanced voice capabilities. All inbound and outbound services that are usually obtained by using different trunk types (such as INWATS, OUTWATS, FX, Tie, and DID) can be accessed with a single ISDN trunk; as a result, the number of system trunks can be reduced by 10 to 15 percent. On outbound calls, the system requests the required service from the Network. The trunk takes on the requested characteristics for the duration of the call.

The PRI card provides two ISDN links and provides the same functionality as the two link ISDN Network Gateway. The PRI card has the Bearer Capabilities (BC) of Speech (voice) and 3.1 kHz audio. The card also transports the BCs of rate-adapted 56 kbs data and unrestricted 64 kbs data transparently through the system.

The PRI card supports the following ISDN network services:

- **Calling Party Number (CPN)** - This number substitutes the calling station number on outgoing calls for purposes of network identification and call back.
- **Calling Name ID (CNID)** - This ID is the incoming calling name delivery per NA DMS100 custom specification or National ISDN-3 (NI3).
- **Calling Line Identification Presentation (CLIP)** - The Calling Party Number can be provided to the ISDN Network for outgoing calls or provided to the PRI card from the ISDN

Network for incoming calls. This information is passed onto the system and can be used for database applications such as screen pops and for inclusion in SMDR records.

- **Calling Line Identification Restriction (CLIR)** - This feature allows users to prevent their telephone number from being presented to the called party.
- **Partial PRI Links** - The SX-200 PRI card will support COs that provide this feature.
- **Direct Dial-In (DDI)** - DDI is an ISDN option that allows direct access to a line behind a system through a unique directory number. This allows the dialed digits of an incoming ISDN call to be presented to the system. All ISDN trunks are treated as Dial-In trunks; the CO always sends digits to the system.
- **Call-By-Call Service Selection (CBC)** - This feature allows telephone users to select the ISDN network services that they wish to use on a per call basis.
- **DID Calling Party Number Forwarding** - Outgoing CPN delivers the calling party's DID number to the Network when the call has been identified as a call from a device with an associated DID number instead of delivering the main directory number associated with the system.
- **Equal Access to Interexchange Carriers** - The system provides a carrier access code to the ISDN Network Gateway which identifies to the Central Office which Interexchange Carrier is to receive the call. The system output a digit string which includes a carrier access code, followed by an identification number, followed by the called number.
- **Min/Max** - This feature allows a customer to control incoming and outgoing call traffic. Minimums are assigned to ensure that a particular type of call (such as INWATS) always has a set number of lines available. Maximums are assigned to limit certain types of calls, i.e., OUTWATS. This ensures that resources are not used up by a single type of call. Different Min/Max databases can be created for different times of the day or for special occasions such as telethons or infomercials.
- **Auto Min/Max** - This feature provides user programmable time-of-day automatic control of Min/Max parameters.
- **NFAS (Non-Facility Associated signaling)** - NFAS allows you to use a single D-channel to handle the signaling requirements for a group of PRI links that all use the same Protocol. This feature eliminates the need to purchase a D-channel for each link. NFAS is mainly for North America.
- **D-Channel Backup** - This feature is used for signaling to establish and maintain the circuit, and to send user data. D-channel Backup provides an alternate D-channel for calls related to NFAS. If the active D-channel fails, the system switches to the backup D-channel to support call processing. This functionality is mainly for North America. NFAS is required in order to program D-channel Backup.
- **Q.SIG** - This feature provides the ability to connect Q.SIG compatible PBXs from different vendors together to form a private network and to connect the SX-200 to the SX-2000 LIGHT system or any other Q.SIG compatible PBX. Q.SIG features that are supported include Calling Name for incoming calls, Message Waiting Indication, Call Transfer, Call Diversion, and Path Replacement.
- **Remote LAN Access** - This feature provides LAN access to the wide area network (WAN) for both incoming and outgoing calls through LAN servers (routers or bridges).
- **Multiple Variants and Configurations** - This feature provides the ability to run multiple protocol variants and program multiple configurations on the two links of the PRI Gateway

through the IMAT application. The option to run multiple variants allows you to connect the PRI Gateway to two different CO switches. The option to run multiple configurations allows you to program Network-side on one link of the PRI Gateway and program User-side on the other link of the PRI Gateway. For more information on programming multiple variants and configurations, refer to the IMAT online Help.

ISDN Network Gateway (North America only)

The ISDN Network Gateway delivers the full benefits of ISDN network services for PRI voice applications. ISDN delivers the highest degree of voice clarity of any transmission medium available.

The ISDN Network Gateway lets you take full advantage of these enhanced voice capabilities including calling number identification services (CLID/ANI) and called-line identification (DDI/DNIS), which allow you to know who's calling and facilitate call center and CTI applications. Plus, the ISDN Network Gateway supports fast call set-up, call-by-call, and Min/Max to speed call handling and make more efficient use of trunking.

SX-200 MyAdministrator

The SX-200 MyAdministrator software application allows the user to perform basic changes to the telephone configuration. With this application, the user connects to the system site locally or remotely and can add, modify, or delete telephone sets; add, modify, or delete telephone features, and control membership in telephone groups.

This application can manage the following device types:

- Mitel Networks 5010, 5020, 5215, and 5220 IP Phones
- Mitel Networks 5305 and 5310 IP Board Room Conference Units
- ONS Stations
- SUPERSET 401 and SUPERSET 4001 (key programming is not supported)
- SUPERSET 410, SUPERSET 4105, SUPERSET 420, SUPERSET 4025, SUPERSET 4125, and SUPERSET 4090
- SUPERSET 430, SUPERSET 4150, and their sub-attendant variants
- Programmable Key Modules

The application identifies the following devices: PKM Interface Unit (DSS/BLF Interface Unit), COV, SUPERSET 3DN telephones, SUPERSET 4DN telephones, and DMP Units. You can not program these devices.

The application works on a Pentium™ computer that has a minimum of 32 MB RAM, a CD-ROM Drive, keyboard and mouse. The application is designed for use with the Microsoft Windows™ 98, Windows 95, Windows 2000 Professional, Windows Millennium Edition, or a Windows NT 4.0 Workstation (Service Pack 4.0 or greater) operating system.

The PBX requirements consist of SX-200 LIGHTWARE 19 Release 1.0 or greater software and the purchasable System Option 80, MyAdministrator Access. The PC is connected to the PBX via the Maintenance Terminal at the back of the SX-200 cabinet. The PC is connected directly with an RS-232 cable or indirectly with two modems, a null modem adapter, and two RS-232 cables. The null modem adapter goes on the PBX side.

System Fail Transfer

System Fail Transfer (SFT) (or power fail transfer) is provided by the SFT control port, allowing preselected DTMF or rotary telephones to be connected directly to CO trunks in the event of system failure in the system. To provide system fail transfer, an external SFT unit or SPINE Bay LS/CLASS trunks are required.

Configuration

By designing your SX-200 EL and SX-200 ML systems for maximum flexibility, Mitel Networks gives you the capability of customizing your system to meet your requirements. Select the system configuration and options you need today with the assurance that you can expand the system at any time in the future.

Reliability is a key factor in the choice of any communications system. Mitel Networks has ensured the continued reliability of the SX-200 EL and SX-200 ML system by designing to wide tolerances and using proven components.

Usability is enhanced by the elegant simplicity of the hardware design - streamlined control architecture, specialized peripheral cards, and flash card-based software.

The SX-200 EL system is a microprocessor-controlled telephone system that switches both voice and data for installation up to 650 lines. It consists of separate cabinets connected by fiber or copper cables. Up to six peripheral bays, including up to two SX-200 IP Nodes, can be connected together. This allows for remote location of peripheral cabinets close to the devices they support and reduces installation costs.

The 96-port control cabinet can hold two Control FIM Carriers (dual or triple) which house the Fiber Interface Modules (FIM) that provide the communication link between the nodes of the distributed PBX system. The Main Control Card (MCC) controls all system operations.

The SX-200 ML system can have one peripheral bay. The SX-200 EL system can have 6 peripheral bays including two SX-200 IP Nodes. The bays may be an SX-200 IP Node, an SX-200 LIGHT peripheral cabinet, an SX-200 EL peripheral cabinet, SX-200 SPINE nodes (24 or 48-ports), ISDN Network Gateways, or PRI cards.

About the Main Control Card

The heart of the system is the Main Control Card (MCC) which interfaces to memory, a Direct Memory Access Controller (DMAC), a Digital Signal Processor (DSP), seven DSP Receivers, a Message Subsystem, and a DX Matrix, through its address, data, and control buses.

In the SX-200 EL system configuration, the MCC IIIEL or MCC IIIELx controls the control cabinet and each peripheral bay through the Bay Control Cards. To control each digital bay, a Control Dual FIM Carrier Card or a Control Triple FIM Carrier Card is installed in the main control cabinet. The MCC IIIEL plugs directly into the SX-200 EL Control Cabinet backplane. The MCCIIIELx must be installed in the SX-200 ELx cabinet to enable the three links to each peripheral bay. The SX-200 EL system can support a maximum of seven bays.

In the SX-200 ML system configuration, the MCC IIIML supports the control cabinet and one additional peripheral bay through its Bay Control Card. The MCC IIIML plugs directly into the SX-200 ML Control Cabinet backplane. The SX-200 ML system can support a maximum of two bays.

In the SX-200 ML (FD) system configuration, the MCC II controls the digital bay through the Bay Control Card to which it is attached.

LIGHTWARE 18 and greater software is enabled by the System ID module on the MCC. The System ID module password is provided by Mitel Networks and defines which options have been purchased. The password and options selection must match that provided on the MOSS sheet which accompanies the system software.

SX-200 EL System Configuration

The SX-200 EL system can support a maximum of seven bays.

LIGHTWARE 19 supports the following peripheral bays:

- SX-200 RM Peripheral Bay
- SX-200 LIGHT Peripheral Bay
- SX-200 SPINE Peripheral Bay
- ISDN Bay (ISDN Network Gateway or PRI card)
- SX-200 IP Node

Note: The PRI card requires LIGHTWARE 17 Release 4.0 and greater. The IP Node requires LIGHTWARE 19 Release 3.0 with Feature Level 4 enabled.

SX-200 EL Control Cabinet

The SX-200 EL and SX-200 ML system use the SX-200 ELx cabinet (PN 9109-600-002-NA) for the main control cabinet and the rack mount peripheral cabinets. The SX-200 ELx cabinet has a steel frame, a plastic door, and an internal structure designed to hold the system cards and components. The front door can be unlocked and removed to allow access to the cards.

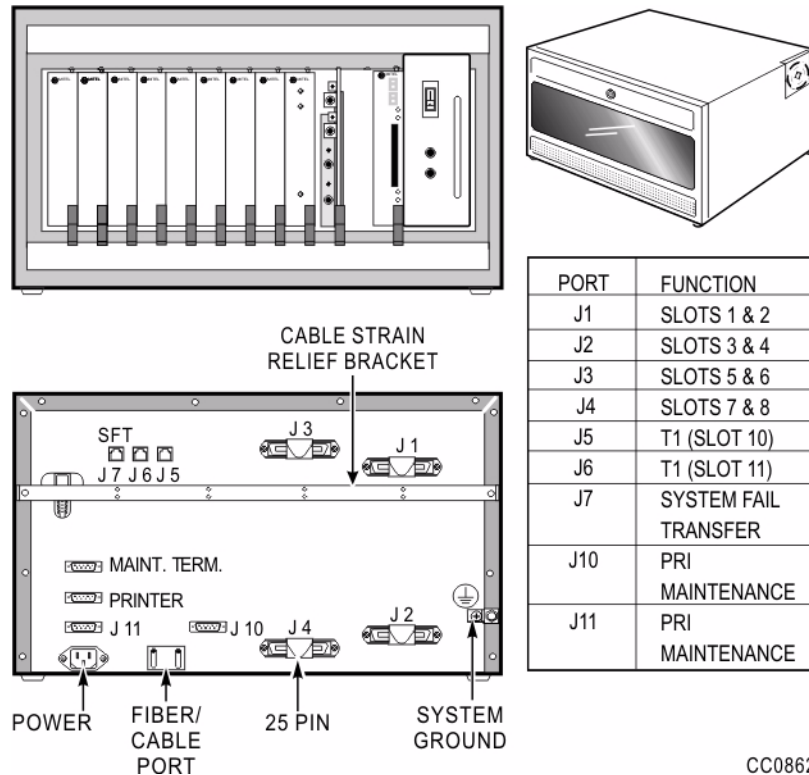

SX-200 ELx Cabinet

Located on the rear of the SX-200 ELx cabinet are four 25 pin connectors (J1- J4 for the peripheral interface cards), three RJ-45 connectors (J5 and J6 for T1 trunks and J7 for a system fail transfer control port), a printer port, a maintenance port, and two RS-232 connectors (J10 and J11 for the PRI maintenance).

The SX-200 EL control cabinet holds the following components:

- Main Control Card IIIELx (MCC IIIELx) or Main Control Card IIIEL (MCC IIIEL)
- Bay Control Card II or Bay Control Card III
- Bay Power Supply
- A maximum of two of the following carrier cards, Control Triple FIM Carrier Card, Control Dual FIM Carrier Card, or Control Triple CIM Card
- Up to one PRI Card
- Up to two T1 links from T1 cards or from the T1/E1 module on a BCC III
- Up to eight Peripheral Interface Cards.

The SX-200 EL control cabinet with a MCC IIIELx or a MCC IIIEL supports up to six additional peripheral bays. The MCC IIIELx enables three links per peripheral bay from the Control Triple FIM Carrier cards and the Control Triple CIM cards.

The SX-200 ELx cabinet Rev 4.4 or greater supports the PRI card, the BRI card, the BCC III, and the CLASS functionality on the ONS/CLASS Line card. The SX-200 ELx cabinet Rev 4.3 or less can support a PRI card if you use an RS-232 Adapter (PN 9109-632-001-NA) to connect the cabinet to the PC.

Main Control Card IIIEL / IIIELx - performs call processing and maintains overall control through communication with up to seven Bay Control Cards. The Main Control Cards have four megabytes of RAM, one megabyte of non-volatile RAM (NVRAM), a System ID Module, a DX module set, tone receivers, seven DSP Receivers for conferencing, and DTMF tone generation. The Main Control Card IIIEL and the Main Control Card IIIELx are not backward or forward compatible.

The MCC IIIEL is available with a Stratum 3 or Stratum 4 clock. The MCC IIIELx is only available with a Stratum 3 clock.

The Main Control Card IIIEL enables the Triple FIM Carrier card to provide two links per peripheral cabinet.

The Main Control Card IIIELx (installed in a universal cabinet PN 9109-610-202-NA) enables the Triple FIM Carrier card to provide three links per peripheral cabinet.

Bay Control Card - interfaces the peripheral cards with the main control card. The SX-200 EL and the SX-200 ML system can use the Bay Control Card II (BCC II) or the Bay Control Card III (BCC III). The BCC III may support a DSP module (single), page 38, a T1/E1 module, page 37, or a Maintenance module, page 36, in a main control cabinet.

Maintenance Module - This is an RS-232 driver module that sits on the BCC III in the main control cabinet. This module provides a serial port for BRI maintenance if the BRI card resides in the main control cabinet.

Bay Power Supply - provides required voltages to peripheral cards, control cards, PRI cards, and system peripheral devices.

CAUTION: Do not install more than one PRI card in the control cabinet. This restriction allows the bay to be within the power budget.

Control Dual FIM Carrier Card - supports two Fiber Interface Modules and connects to the backplane. The card distributes 6 links to two bays: 3 links per bay. One 1 km FIM is onboard the Control Dual FIM Carrier card. A connector is on the card for an additional FIM.

Control Triple FIM Carrier Card MM 1 km - supports up to three Fiber Interface Modules and connects them to the backplane. With a MCCIIIEL card, the Control Triple FIM card distributes 6 links to three bays: 2 links per bay. With a MCCIIIELx card, the Control Triple FIM card distributes 9 links to three bays: 3 links per bay. It has two 1 km FIMs onboard and a connector to plug in a third optional FIM (either a 1 km FIM or an extended FIM).

Control Triple FIM Carrier Card MM 5km - similar to the Control Triple FIM Carrier Card with the exception that this card has two multi-mode 5 km FIMs onboard and a connector to plug in a third optional FIM (either a 1 km FIM or an extended FIM).

Control Triple FIM Carrier Card SM 14km - similar to the Control Triple FIM Carrier Card with the exception that this card has two single mode 14 km FIMs onboard and a connector to plug in a third optional FIM (either a 1 km FIM or an extended FIM).

Fiber Interface Module (FIM) - supports the transmission of voice and data signals over fiber optic cables. The FIM plugs into the Control FIM Carrier. Three Fiber Interface Modules are available with ranges of 1 km, 5 km, and 14 km. Both FIMs at each end of a fiber cable must be the same type. Onboard FIMs in the Control Dual FIM Carrier, Control Module II, and Application Fiber Controller (AFC) card are 1 km FIMs. Add on FIMs are ordered separately.

Control Triple CIM Card - provides three onboard Copper Interface Module (CIM) circuits. The card also has a connector for a FIM II so that a FIM II may be used in place of one of the CIM circuits. The card may be used for an SX-200 EL system or an SX-200 ML system. A manual switch determines whether the card emulates a Dual or Triple FIM Carrier card. Any SX-200 rack-mount cabinet supports the Control Triple CIM Card.

Copper Interface Module (CIM) - supports the transmission of voice and data signals over copper cables that provide connectivity between the main control cabinet and the peripheral cabinets. The CIM uses a twisted pair interface with standard Category 5 cable. The CIM is similar to the FIM in the way that it provides 3 ST links. In a main control cabinet, the CIM plugs onto the PRI card. In a peripheral cabinet, the CIM plugs onto the BCC III, Peripheral Interface Module Carrier card, or the PRI card. The CIM supports connectivity of cabinets up to 30 meters or 100 feet apart. The copper interface modules are ideal for a co-located system.

FIM II - supports the transmission of voice and data signals over fiber optic cables that provide connectivity between the main control cabinet and the peripheral cabinets. The FIM II plugs into the PRI card, the BCC III, Peripheral Interface Module Carrier card, or the Control Triple CIM Card. The FIM II modules are available with ranges of 1 km, 5 km, and 14 km. The FIM II can connect with a FIM, however the fiber interface module at each end of the fiber cable must have the same range. The FIM II is ideal for distributed systems (cabinets greater than 10 meters apart).

PRI Card - provides up to two links of ISDN connectivity with the T1/E1 module that is installed on the PRI card. The PRI card requires LIGHTWARE 17 Release 4 or greater software and a SX-200 ELx cabinet Rev 4.4 or greater (PN 9109-600-002-NA).

The SX-200 ELx cabinet Rev 4.3 or less can support a PRI card if you use an RS-232 Adapter (PN 9109-632-001-NA) to connect the cabinet to the PC. The PRI card can also hold a FIM II or CIM. A PRI card installed in a control cabinet does not require a FIM II or CIM because the card connects directly to the backplane of the control cabinet. A PRI card installed in a peripheral cabinet does require a FIM II or CIM to connect the PRI card to the main control cabinet.

T1/E1 Module - contains two digital trunk connections which can be configured as either having a T1 style interface (1.544Mbps/s) or an E1 style interface (2.048Mbps/s).The SX-200 only uses the T1 style interface.The two T1 connections, also referred to as circuits or links, support 48 channels.The T1/E1 module can be programmed for Extended Superframe (ESF) and also

has Channel Service Unit (CSU) functionality. The T1/E1 module is installed on the PRI card providing PRI connectivity or on the Bay Control Card III providing all the features and functionality of the T1 card with 48 channels.

DSP Module (Single) - provides 8 CLASS generators for ONS/CLASS sets and provides 16 conference bridges for Record a Call. This DSP module also provides 16 DTMF receivers thus eliminating the need for a Universal Card. The DSP module sits on the BCC III. For CLASS functionality, the DSP module must be in the same cabinet as the ONS/CLASS Line card. For the Record a Call conference bridges, the DSP module must also be in the same bay.

Peripheral Interface Cards - interface trunks and peripheral devices, such as telephones, SUPERSET telephones, Programmable Key Modules, and datasets to the system. Up to eight peripheral interface cards (PICs) can be installed in Slots 1 to 8. See PICs, page 52, for a description.

System Software Storage - LIGHTWARE 19 is provided on a 4-megabyte PCMCIA memory card (flash card). The core software occupies 2MB and the BCC III software occupies 2MB. Because the remote software download requires an extra 2MB of free space, the remote software download of LIGHTWARE 19 must be done in a two-step process. When the system is powered up, call processing and maintenance software is loaded from PCMCIA memory to the MCC III RAM. The BCC III software is also downloaded from the flash card to the BCC III.

Customers with a 2MB flash card are not able to upgrade to LIGHTWARE 19.

Customer Data Entry Storage - CDE software is stored in NVRAM, and can also be stored on an off-board personal computer. When the system is powered up, CDE software is loaded from NVRAM to the Main Control card RAM.

Backplane - the Main Control Card III, the Bay Control Card, the PRI card, the Bay Power Supply, and the eight Peripheral Interface Cards plug into connectors on the backplane.

SX-200 EL CONTROL CABINET EXAMPLES

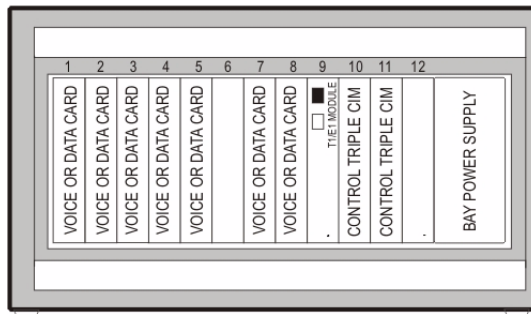
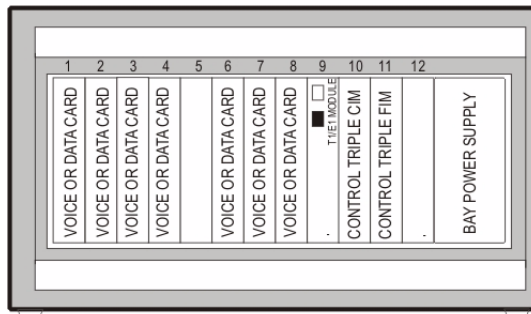

■ = CONNECTION IN USE

CC0949

SX-200 EL PERIPHERAL CABINET EXAMPLES

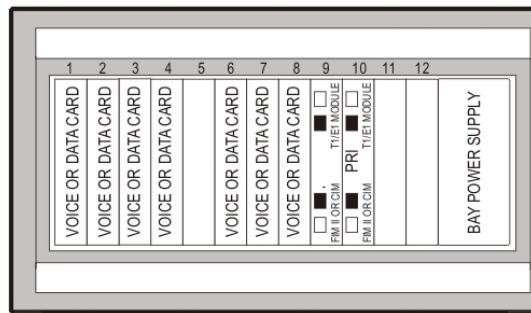
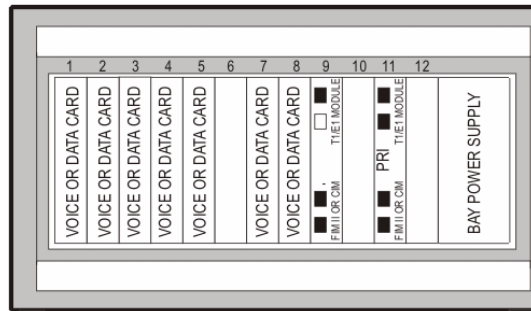

■ = CONNECTION IN USE

CC0950

Connecting Peripheral Bays

Up to six peripheral bays connect to the SX-200 EL main control cabinet. You have a choice on fiber connectivity or copper connectivity. Copper provides a cost-effective solution for co-located systems.

To obtain **fiber connectivity**, the system requires Fiber Interface Modules (FIM or FIM II) on carrier cards in the main control cabinet and each peripheral cabinet. Cabinet connectors can use a FIM or FIM II which means that a FIM can connect to a FIM, a FIM II can connect to a FIM II, or a FIM can connect to a FIM II. The only restriction is that both fiber interface modules must be of the same variant (1, 5 or 14 km), that is, a 1 km FIM must connect to a 1 km FIM II. The carrier card differs depending upon the configuration.

- In the main control cabinet, the FIM sits on a Control Dual FIM Carrier card or a Control Triple FIM Carrier card. The FIM II sits on a PRI card or on the Control Triple CIM card.
- In the peripheral cabinets, the FIM sits on a Peripheral FIM Carrier II Card. The FIM II sits on a Bay Control Card III (BCC III), on a Peripheral Interface Module Carrier card, or on a PRI card. The same variant of fiber interface module (1, 5 or 14 km) must be at both ends.

To obtain **copper connectivity**, the system requires a copper interface in the main control cabinet and each peripheral cabinet. The CIM (Copper Interface Module) supports a distance of up to 30 meters or 100 feet between cabinets. There is only one variant of the CIM; unlike the FIM and FIM II which have three variants.

- In the main control cabinet, the copper interface is a Control Triple CIM card (three onboard CIM circuits) or a CIM that sits on a PRI card.
- In the peripheral cabinets, a CIM sits on a Bay Control Card III (BCC III), on a Peripheral Interface Module Carrier card, or on a PRI card. The CIM sits on the same cards as the FIM II does, but in a different position; the CIM is not recessed back from the faceplate.

If the peripheral cabinet has a BCC III, the FIM II or CIM on the BCC III provides the fiber or copper connectivity, to the main control cabinet.

If the peripheral cabinet has a BCC II, the FIM II or CIM on the Peripheral Interface Module Carrier card provides the fiber or copper connectivity to the main control cabinet. Older cabinets can still use the FIM on the Peripheral Interface Carrier II card.

Note: Remember that the PRI card in a peripheral cabinet is a separate bay on its own and therefore requires its own FIM II or CIM to connect to the main control cabinet.

The Control FIM Carrier cards and the Control Triple CIM cards connect the main control cabinet to the peripheral bays. Up to six peripheral bays connect to the SX-200 EL main control cabinet.

- Control Dual FIM Carrier card allows the connection of up to two peripheral bays
- Control Triple FIM Carrier card allows the connection of up to three peripheral bays
- Control Triple CIM card allows the connection of up to three peripheral bays.

You can have either two or three links to each peripheral bay:

- With a MCCIII EL / ELx control card, the Control Dual FIM Carrier card or the Control Triple CIM card provides three links per peripheral bay

- With an MCCIII EL control card, the Control Triple FIM Carrier card or the Control Triple CIM card provides two links per peripheral bay
- With an MCCIII ELx control card (installed in a SX-200 ELx cabinet PN 9109-600-002-NA) the Triple FIM Carrier card or the Control Triple CIM card provides three links per peripheral bay.

Note: A manual switch on the Control Triple CIM card controls whether the card will emulate a Control Dual FIM Carrier card or a Control Triple FIM Carrier card.

If you provide two links to each bay:

- You can have a maximum of seven cabinets in the system
- Prior to LIGHTWARE 18 Release 2.0, you could have one bay with two T1 trunk cards and the other bays with one T1 trunk card to total a maximum of seven T1 trunk cards in the system
- With LIGHTWARE 18 Release 2.0 or greater, you can have a total of 8 T1 links in the system with a maximum of 2 T1 links per bay
- If a T1 trunk card is installed in slot 10 of a bay, you cannot install a peripheral interface cards in slot 5; if a T1 trunk card is installed in slot 11, you cannot install a peripheral interface card in slot 6
- T1 links from a T1/E1 module on a BCC III also occupy slots 5 and 6 in software only
- Calls must be evenly distributed across all bays
- Maximum channel blocking ratio is 0.58.

Note: As a guideline to achieve a P.0001 grade of service (one failure in 10,000 calls) for a Bay connected via a Control Triple FIM Carrier, the recommended maximum calls/hour is 500 based on traffic tables. With a typical call hold time of 2 minutes and 12 seconds the total Erlang rate is 18.33 (660 CCS) for the whole Bay. The half Bay would therefore be 9.17 Erlangs (330 CCS) at 250 calls/hour. It is important that calls be evenly distributed across all Bays.

If you provide three links to each bay

- You can have a maximum of seven cabinets in the system
- Prior to LIGHTWARE 18 Release 2.0, you could have one bay with two T1 trunk cards and the other bays with one T1 trunk card to total a maximum of seven T1 trunk cards in the system.
- With LIGHTWARE 18 Release 2.0 or greater, you can have a total of 8 T1 links in the system with a maximum of 2 T1 links per bay.
- If a T1 trunk card is installed in slot 10 of a bay, you cannot install a peripheral interface cards in slot 5; if a T1 trunk card is installed in slot 11, you cannot install a peripheral interface card in slot 6.
- T1 links from a T1/E1 module on a BCC III also occupy slots 5 and 6 in software only.
- Calls do not have to be evenly distributed across all bays
- Maximum channel blocking ratio is 0.94.

Connecting SX-200 IP Nodes

You can connect up to two IP Nodes to the SX-200 EL. The system requires one Control Triple CIM card (three onboard CIM circuits) in the main control cabinet and one Bay Control Card III.

The following connections are required to configure the SX-200 IP Node:

- Connections between peripheral bays and the main control cabinet are made with standard CIM connections, page 40.
- An Ethernet crossover cable connects the Control Triple CIM Card in the main control cabinet to CIM port 4 on the IP Node. All voice communications are carried over this connection.
- A standard Ethernet cable connects the Bay Control Card III to the Local Area Network (LAN). This connection carries the signaling information.
- Another Ethernet crossover cable connects the IP Node to the Ethernet switch on the LAN.
- The IP phones are connected to the LAN through the Ethernet switch.

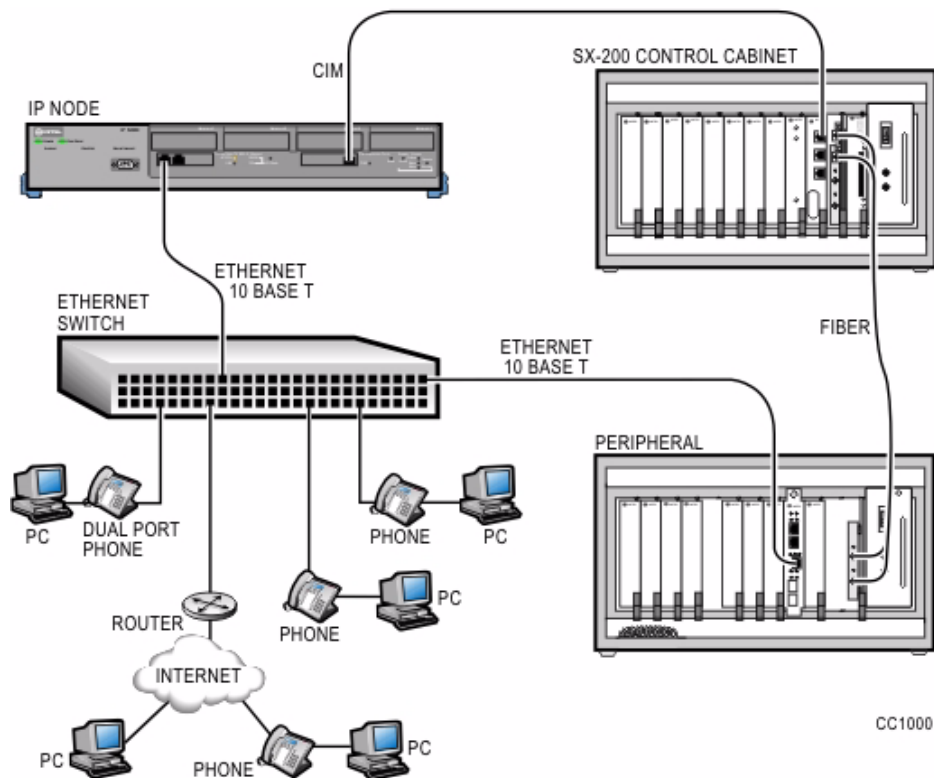

The configuration rules that apply to connecting standard peripheral bays to the control cabinet through CIMs also apply to connecting IP Nodes. For more information about configuration, see the Configuration Rules for the

- SX-200 EL Control Cabinet
- Bays supported by the SX-200 EL System
- Control Triple CIM Card and the SX-200 EL System
- SX-200 IP Node Local Area Network Design Guidelines

Maximum Number of T1 Links

LIGHTWARE 18 Release 2.0 and greater supports a maximum number of eight T1 links in the system. These links can be from the T1 cards and from the T1/E1 modules. Any bay can have a maximum of two T1 links to a total of eight T1 links in the system.

Notes:

1. The T1/E1 module offers all the same functionality as the T1 card, plus CSU functionality, ESF operation, plus an extra link of T1/D4 connectivity. The T1/E1 module offers up to two links of T1/D4 connectivity.
2. The T1 links in a bay (from a T1 card or a T1/E1 module) still logically occupy slots five and six in that bay.
3. The number of T1 links from T1 cards are not controlled by the purchasable Moss Option, Number of Links (0-8). This option limits the number of T1 links from T1/E1 modules; i.e. the T1 links from PRI cards and BCC III cards are counted in this total.
4. A cabinet may have a T1/E1 module on a PRI card and a T1/E1 module on the Bay Control Card III in the same cabinet. This configuration is possible because the software sees the PRI card as a separate bay.

Prior to LIGHTWARE 18 Release 2.0, the maximum number of T1 Trunk cards was dependent on the types of FIM Carrier Cards and the number of bays in the system. Up to six peripheral bays can be connected to the SX-200 EL main control cabinet. The Control Dual FIM Carrier (CFCII) card allows the connection of up to two peripheral bays. The Control Triple FIM Carrier (CFCIII) card allows the connection of up to three peripheral bays.

Maximum Number of T1 Trunk Cards (LIGHTWARE 17)		
Number of Bays	FIM Carrier Cards	Maximum T1 Trunk Cards
1	none	2
2	one CFCII	3
3	one CFCII	4
4	two CFCII	4
5	two CFCII	5
6	one CFCII and one CFCIII	6
7	two CFC III	7

SX-200 ML System Configuration

The SX-200 ML system is similar to the SX-200 EL system, page 34, except that the SX-200 ML control cabinet uses a Main Control Card IIIML (MCC IIIML), holds one Control Dual FIM Carrier card or a Control Triple CIM card and supports only one peripheral bay.

Main Control Card IIIML - performs call processing and maintains overall control through communication with one or two Bay Control Cards. Four megabytes of RAM, one megabyte of non-volatile RAM (NVRAM), a System ID Module, a DX module, and a Stratum 3 or Stratum 4 clock are part of the Main Control Card IIIML. The MCC IIIML provides tone receivers, seven DSP receivers, conferencing, and DTMF tone generation.

System Software Storage - LIGHTWARE 19 software is provided on a 4-megabyte PCMCIA memory card (flash card). The core software occupies 2MB and the BCC III software occupies 2MB. Because the remote software download requires an extra 2MB of free space, the remote software download of LIGHTWARE 19 software must be done in a two-step process. When the system is powered up, call processing and maintenance software is loaded from PCMCIA memory to the MCC III RAM.

Customers with a 2MB flash card are not able to upgrade to LIGHTWARE 19.

Customer Data Entry Storage - CDE software is stored in NVRAM, and can also be stored on an off-board personal computer. When the system is powered up, CDE software is loaded from NVRAM to the Main Control card RAM.

Bay Control Card - interfaces the peripheral cards with the main control card. The bay control cards are installed in the main control cabinet and the peripheral cabinet. The SX-200 ML system can use the Bay Control Card II (BCC II) or the Bay Control Card III (BCC III). The BCC III may support a DSP module (single), page 38, a T1/E1 module, page 37, a Maintenance module,, page 36, and a FIM II, page 50, or a CIM, page 50. Note that the BCC III does not support a FIM II or a CIM in a main control cabinet.

Maintenance Module - This is an RS-232 driver module that sits on the BCC III in the main control cabinet. This module provides a serial port in the main control cabinet for the maintenance procedures on the BRI card.

DSP Module (Single) - provides 8 CLASS generators for ONS/CLASS sets and provides 16 conference bridges for Record a Call. This DSP module also provides 16 DTMF receivers thus eliminating the need for a Universal Card. The DSP module sits on the BCC III. For CLASS functionality, the DSP module must be in the same cabinet as the ONS/CLASS Line card. For the Record a Call conference bridges, the DSP module must be in the same cabinet as the user's circuit.

Control Dual FIM Carrier Card - supports up to two Fiber Interfaces Module and connects them to the backplane. It has a 1 km FIM onboard and a connector to plug in a second optional FIM (either a 1 km FIM or an extended FIM).

Fiber Interface Module (FIM) - supports the transmission of voice and data signals over fiber optic cables. The FIM plugs into the Control FIM Carrier. Three Fiber Interface Modules are available with ranges of 1 km, 5 km, and 14 km. Both FIMs at each end of a fiber cable must be the same type.

Control Triple CIM Card - provides three copper interface module circuits. The card also has a connector for a FIM II so that a FIM II may be used in place of one of the CIM circuits. The card may be used for an SX-200 EL system or an SX-200 ML system; the technician sets a manual switch so the card may emulate a Dual or Triple FIM Carrier card.

Copper Interface Module (CIM) - supports the transmission of voice and data signals over copper cables that provide connectivity between the main control cabinet and the peripheral cabinets. The CIM uses a twisted pair interface with standard Category 5 cable. The CIM is similar to the FIM in the way that it provides 3 ST links. In a main control cabinet, the CIM plugs onto the PRI card. In a peripheral cabinet, the CIM plugs onto the BCC III, Peripheral Interface

Module Carrier card, or the PRI card. The CIM supports connectivity of cabinets up to 30 meters or 100 feet apart. The copper interface modules are ideal for a co-located system.

FIM II - supports the transmission of voice and data signals over fiber optic cables that provide connectivity between the main control cabinet and the peripheral cabinets. In a main control cabinet, the FIM II plugs onto the Control Triple CIM card. In a peripheral cabinet, the FIM II plugs onto the BCC III or Peripheral Interface Module Carrier card. The FIM II modules are available with ranges of 1 km, 5 km, and 14 km. A FIM II can attach to a FIM as long as the fiber interface module at each end of the fiber cable is the same distance.

PRI Card - provides one or two links of ISDN connectivity with the T1/E1 module that is installed on the PRI card. The PRI card requires LIGHTWARE 17 Release 4.0 or greater and a SX-200 ELx cabinet Rev 4.4 or greater (PN 9109-600-002-NA). The PRI card in a SX-200 ML system connects directly into the backplane of the main control cabinet.

T1/E1 Module - contains two digital trunk connections which can be configured as either having a T1 style interface (1.544Mbps/s) or an E1 style interface (2.048Mbps/s). The SX-200 only uses the T1 style interface. The two T1 connections, also referred to as circuits or links, support 48 channels. The T1/E1 module can be programmed for Extended Superframe (ESF) and has Channel Service Unit (CSU) functionality. The T1/E1 module is installed on the PRI card to provide PRI connectivity or on the Bay Control Card III providing all the features and functionality of the T1 card with 48 channels.

Peripheral Interface Cards - interface trunks and peripheral devices, such as telephones, SUPERSET telephones, and datasets into the system. Up to eight Peripheral Interface Cards (PICs) can be installed in Slots 1 to 8. PICs are described later in this Section.

Bay Power Supply - provides required voltages to peripheral cards, control cards, and system peripheral devices.

Backplane - the Main Control Card III, the Bay Control Card, the PRI card, the Bay Power Supply, and the eight Peripheral Interface Cards plug into connectors on the backplane.

SX-200 ML CONFIGURATION EXAMPLE

CONTROL CABINET

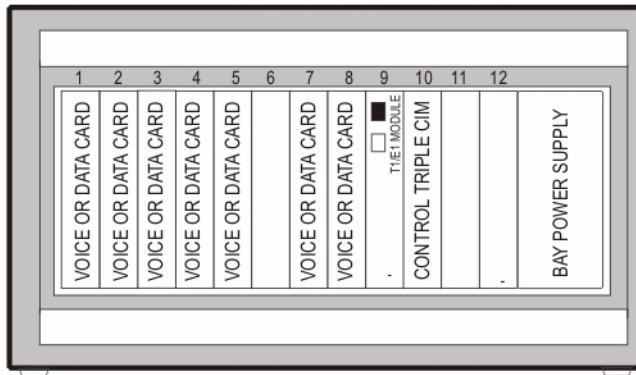

PERIPHERAL CABINET

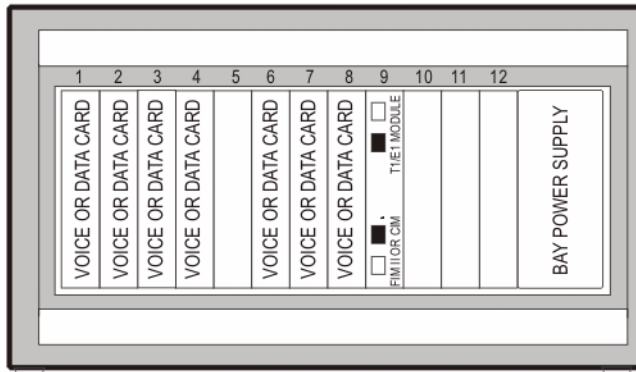

■ = CONNECTION IN USE

CC0948

Another configuration for the SX-200 ML exists when the cabinets do not have a BCC III. The FIM II or CIM on the Peripheral Interface Module Carrier Card (PIMCC) provides the connectivity to the main control cabinet.

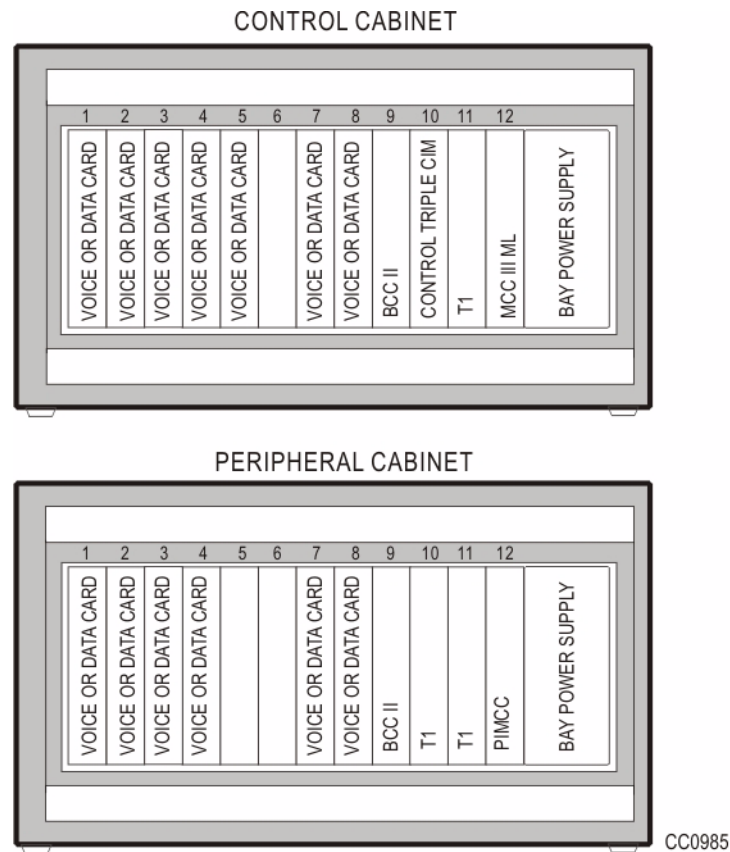

Connecting a Peripheral Bay

The SX-200 ML system supports only one peripheral bay.

Note: The system counts a PRI card sitting in a main control cabinet as a peripheral bay. The PRI card does not require a CIM or FIM II to connect to the main controller.

For **fiber connectivity**, the main control cabinet and the peripheral cabinet must have a fiber interface module (FIM or FIM II). A FIM can connect to a FIM, a FIM II can connect to a FIM II, or a FIM can connect to a FIM II and vice versa. The only restriction is that both fiber interface modules must be of the same variant (1, 5 or 14 km), that is, a 1 km FIM must connect to a 1 km FIM II.

- The SX-200 ML main control cabinet can have in slot 10, a Control Dual FIM Carrier card with the 1 km FIM (on-board), or a Control Triple CIM card with a FIM II that connects to a second peripheral bay (Bay 2). If the peripheral cabinet has a BCC III, the BCC III supports a FIM II. If the peripheral cabinet has a BCC II, the peripheral cabinet can have a Peripheral Interface Module Carrier card with a FIM II or a Peripheral FIM Carrier II card with a FIM.

For **copper connectivity**, the main control cabinet and the peripheral cabinet must have a copper interface module (CIM). The CIM supports a distance of up to 30 meters or 100 feet between cabinets. There is only one variant of the CIM; unlike the FIM and FIM II which have three variants.

- The SX-200 ML main control cabinet supports a Control Triple CIM card in slot 10 to connect a second peripheral cabinet (Bay 2). If the peripheral cabinet has a BCC III, the BCC III supports a CIM. If the peripheral cabinet has a BCC II, the Peripheral Interface Module Carrier card supports a CIM.

Note: A manual switch on the Control Triple CIM card controls whether the card will emulate a Control Dual FIM Carrier card or a Control Triple FIM Carrier card.

The Control Dual FIM Carrier card or the Control Triple CIM card provides three links to the peripheral bay.

The following rules apply:

- Prior to LIGHTWARE 18 Release 2.0 , you could have one bay with two T1 trunk cards and the other bay with one T1 trunk card to total a maximum of three T1 trunk cards in the system
- With LIGHTWARE 18 Release 2.0 or greater software, you can have a maximum of four T1 links in the SX-200 ML system, with each bay having two T1 links
- If a T1 trunk card is installed in slot 10 of a bay, you cannot install a peripheral interface card in slot 5; a T1 trunk card in slot 11 occupies slot 6
- Two T1 links from a T1/E1 module on a BCC III occupies slots 5 and 6 (software only)
- Maximum channel blocking ratio is 0.94.

SX-200 ML (FD) System Configuration

The cabinet holds one Main Control Card II (MCC II), one Bay Control Card II, one Bay Power Supply, and up to eight Peripheral Interface Cards. Located on the rear of the cabinet is a connector panel for printer and maintenance ports, and the SFT (system fail transfer) control port. The SX-200 ML (FD) PBX Control cabinet supports one peripheral bay. When a second bay is added, a Control FIM Carrier is installed in slot 4 of the Control cabinet, reducing its number of ports to 84.

Main Control Card II - performs call processing and maintains overall control through communication with the Bay Control Card. Four megabytes of RAM, one megabyte of non-volatile RAM (NVRAM), a System ID Module, a DX module, and a Stratum 3 or Stratum 4 clock are part of the Main Control Card II. The MCC II provides seven tone receivers, conferencing, and DTMF tone generation.

System Software Storage - system software is stored on a 2-megabyte PCMCIA memory card or an optional 4-megabyte PCMCIA memory card (required for remote software upgrade feature). When the system is powered up, call processing and maintenance software is loaded from PCMCIA memory to the MCC II RAM.

Customer Data Entry Storage - CDE software is stored in NVRAM, and can also be stored on an off-board personal computer. When the system is powered up, CDE software is loaded from NVRAM to the MCC II RAM.

Bay Control Card II - interfaces the peripheral cards with the Main Control Card.

Control FIM Carrier Card - supports the Fiber Interface Module and connects to the MCC II via a ribbon cable. The Control FIM Carrier Card plugs into slot 4 of the backplane.

Fiber Interface Module (FIM) - supports the transmission of voice and data signals over fiber optic cables. The FIM plugs into the Control FIM Carrier.

Peripheral Interface Cards - interface trunks and peripheral devices, such as telephones, SUPERSET telephones, and datasets into the system. Up to eight Peripheral Interface Cards (PICs) can be installed in Slots 1 to 8. PICs are described later in this section.

Bay Power Supply - provides required voltages to peripheral cards, control cards, and system peripheral devices.

Backplane - the Bay Control Card, the Bay Power Supply, and the eight Peripheral Interface Cards plug into connectors on the backplane.

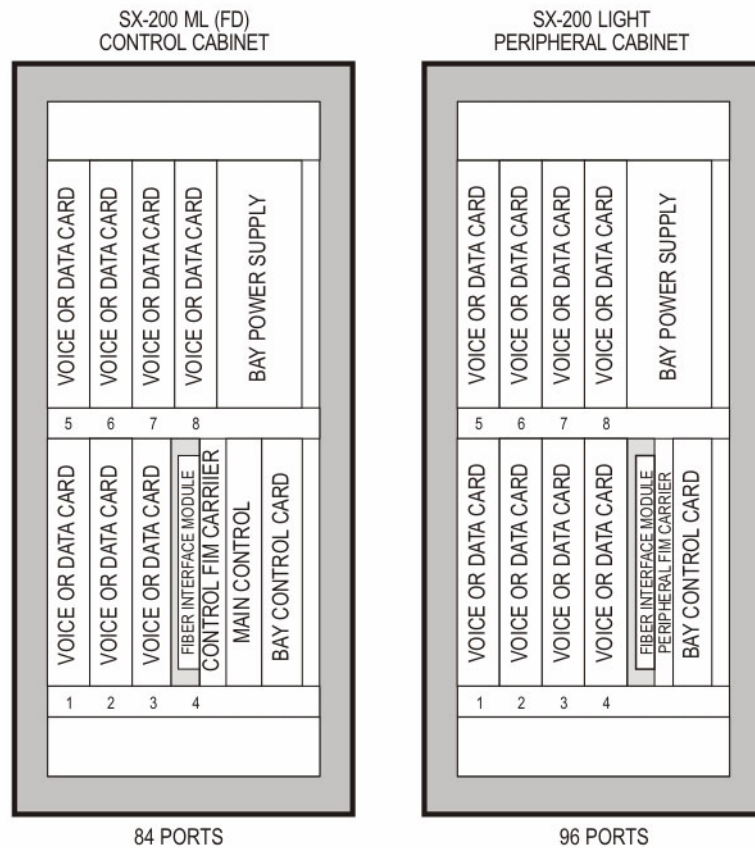

CC0813

SX-200 ML (FD) Configuration

SX-200 RM Peripheral Cabinet

The SX-200 RM peripheral cabinet supports a Bay Power Supply, a Bay Control card, a PRI card, a T1 card, a Peripheral FIM Carrier II card or a Peripheral Interface Module Carrier card, and up to eight Peripheral Interface Cards. The peripheral cabinet is the same cabinet as the SX-200 EL control cabinet.

Note: The BCC III, Peripheral Interface Module Carrier card, and the PRI card require the SX-200 ELx cabinet. These cards support a FIM II or a CIM to connect the bay to the control cabinet.

Components of the peripheral cabinet include:

Bay Control Card - interfaces the peripheral cards with the Main Control Card III in the Control Cabinet. The Bay Control Card (BCC) comes in two variants: BCC II and BCC III. The BCC III has more processing power that is required for ISDN connectivity (BRI and PRI cards). The BCC III in a peripheral cabinet also supports a DSP Module (Single), a T1/E1 Module, a FIM II or a CIM. The BCC III requires an SX-200 ELx cabinet.

DSP Module (Single) - provides CLASS generators for ONS/CLASS sets and provides conference bridges for Record a Call. This DSP module also provides 16 DTMF receivers thus eliminating the need for a Universal Card. The DSP module sits on the BCC III. For CLASS functionality, the DSP module must be in the same cabinet as the ONS/CLASS Line card. For the Record a Call conference bridges, the DSP module must be in the same cabinet as the user's circuit.

T1/E1 Module - contains two digital trunk connections which can be configured as either having a T1 style interface (1.544Mbits/s) or an E1 style interface (2.048Mbits/s). The SX-200 only uses the T1 style interface. The two T1 connections, also referred to as circuits or links, support 48 channels. The T1/E1 module has an Extended Superframe (ESF) and has built in Channel Service Unit (CSU) functionality. The T1/E1 module is installed on the PRI card or on the BCC III.

FIM II - connects the peripheral cabinet or the ISDN bay (PRI card) to the FIM II in the main control cabinet. The FIM II is installed on the PRI card, Peripheral Interface Module Carrier card, or on the Bay Control Card III in a peripheral cabinet. The FIM II has three variants: 1 km, 5 km, and 14 km. The fiber interface module must be the same type at both ends (main control cabinet and peripheral cabinet).

Copper Interface Module (CIM) - supports the transmission of voice and data signals over copper cables that provide connectivity between the main control cabinet and the peripheral cabinets. The CIM uses a twisted pair interface with standard Category 5 cable. The CIM is similar to the FIM in the way that it provides 3 ST links. In a peripheral cabinet, the CIM plugs onto the BCC III, Peripheral Interface Module Carrier card, or the PRI card. The CIM supports a minimum distance of ten meters between cabinets. The copper interface modules are ideal for a co-located system.

PRI Card - provides one or two links of ISDN connectivity with the T1/E1 module that is installed on the PRI card. The PRI card requires LIGHTWARE 17 Release 4.0 or greater software and a SX-200 ELx cabinet (PN 9109-600-002-NA). The PRI card also holds a FIM II or a CIM. The FIM II or CIM connects the PRI card bay to the interface module in the main control cabinet. The SX-200 EL peripheral cabinet can hold up to 2 PRI cards.

Peripheral Interface Module Carrier Card - supports the FIM II or the CIM. The Peripheral Interface Module Carrier Card (PIMCC) replaces the Peripheral FIM Carrier II card. The Peripheral Interface Module Carrier Card (PIMCC) provides fiber or copper connectivity from the peripheral cabinet to the main control cabinet using a CIM (Copper Interface Module) or a FIM II. The Peripheral Interface Module Carrier card provides connectivity when the peripheral cabinet has a BCC II instead of a BCC III.

Peripheral FIM Carrier II Card - supports the Fiber Interface Module, the RS-232 maintenance port, and the system fail transfer circuit. The Peripheral FIM Carrier II Card plugs into slot 12 (same slot as the MCC III in the Control Cabinet).

Fiber Interface Module (FIM) - supports the transmission of voice and data signals over fiber optic cables. The FIM plugs into the Peripheral FIM Carrier Card.

Peripheral Interface Cards - interface trunks and peripheral devices, such as telephones, SUPERSET telephones, and datasets into the system. Up to eight Peripheral Interface Cards (PICs) can be installed in Slots 1 to 8 of the peripheral cabinet. In an SX-200 RM cabinet, T1 trunk cards plug into slots 10 and 11 (slots 5 and 6 respectively must then be left vacant). See Peripheral Interface Cards, page 52, for more information.

Peripheral Backplane - the Bay Control Card, the Bay Power Supply, and the eight Peripheral Interface Cards plug into connectors on the peripheral backplane.

SX-200 LIGHT Peripheral Cabinet

The SX-200 LIGHT Peripheral Cabinet has a single bay that contains a Bay Power Supply, a Bay Control Card II, a Peripheral FIM Carrier and Fiber Interface Module (FIM), and up to eight Peripheral Interface Cards.

Components of the SX-200 LIGHT Peripheral cabinet include:

Bay Control Card II - interfaces the peripheral cards with the Main Control Card II in the Control cabinet.

Peripheral FIM Carrier Card - supports the Fiber Interface Module, the RS-232 maintenance port, and the system fail transfer circuit. The Peripheral FIM Carrier Card plugs into the Bay Control Card.

Fiber Interface Module (FIM) - supports the transmission of voice and data signals over fiber optic cables. The FIM plugs into the Peripheral FIM Carrier Card.

Peripheral Interface Cards - interface trunks and peripheral devices, such as telephones, SUPERSET telephones, and datasets into the system. Up to eight Peripheral Interface Cards (PICs) can be installed in Slots 1 to 8 of the peripheral cabinet. PICs are described later in this Section.

Peripheral Backplane - the Bay Control Card, the Bay Power Supply, and the eight Peripheral Interface Cards plug into connectors on the peripheral backplane.

Peripheral Interface Cards and Modules

The SX-200 EL and the SX-200 ML cabinet hold a main control card and a bay control card with peripheral interface cards in slots one to eight. The SX-200 SPINE holds a peripheral control module and a power module with Loop Start (LS) trunks and LS/CLASS II modules, ONS, DNIC and CLASS modules.

The SX-200 LIGHT Peripheral cabinet has up to four high-power digital peripheral cards which can only plug into upper card slots; low-power digital peripheral cards can plug into upper or lower card slots. The SX-200 rack mount cabinet used for the SX-200 EL and SX-200 ML supports up to four high power cards which may be plugged into any slots; low-power digital peripheral cards can plug into the remaining card slots.

The high power cards have the ■ symbol on the face of the peripheral interface card.

The low power cards have the ● symbol on the face of the peripheral interface card.

Universal Card ■

The Universal Card is a high power card that holds up to four modules. If more than the seven receivers provided by the Main Control Card are required on a system, a Universal Card and one or more Receiver Modules must be installed. Each module is assigned a power rating. The cumulative ratings of the modules on the Universal Card cannot exceed a value of 10. The modules are as follows:

- Receiver/Relay Module (contains four DTMF receivers and two relays) (power rating = 2)
- Music-on-Hold/Pager Module (contains one music input, one PA paging output) (power rating = 1)
- E&M Trunk Module (contains one E&M trunk) (power rating = 3)
- LCD Console Interface Module (power rating = 5)

ONS/CLASS Line Card ●

The ONS/CLASS Line card is a low power card and replaces the ONS Line card. The card has the same functionality as the ONS Line card and if software enabled, offers CLASS functionality.

The ONS/CLASS Line card has 12 DTMF/Rotary line circuits per card. The card accepts up to three industry-standard DTMF/Rotary telephone sets per line circuit. The card interfaces the telephone analog input with the system's digital crosspoint network. It converts the analog telephone signals into the digital format used by the system, and converts the digital information back into the analog signals required by the telephone sets.

The ONS/CLASS Line card is backwards compatible. The card provides the ONS Line functionality as a default to the SX-200 DIGITAL, the SX-200 LIGHT, the SX-200 ML (FD), the SX-200 EL and the SX-200 ML systems. The CLASS functionality is enabled by a purchasable MOSS option and is only offered to the SX-200 EL and the SX-200 ML systems. CLASS also requires LIGHTWARE 18 Release 2.0 or greater and an SX-200 ELx cabinet with a BCC III holding a DSP module (single). The ONS/CLASS Line card must reside in the same cabinet as the BCC III.

Digital Line Card ●

The Digital Line Card (DLC) is a low power card with 12 Digital Network Interface Circuits (DNIC) per card. The Digital Line Card interfaces DNIC-based peripheral devices to the system through its Digital Network Interface Circuits (DNIC); the DNIC is a proprietary integrated circuit. DNIC devices include SUPERSET 4001, SUPERSET 4015, SUPERSET 4025, SUPERSET 4125, SUPERSET 4150, SUPERSET 4090, SUPERSET 401+, SUPERSET 410, SUPERSET 420, SUPERSET 430 telephones, Programmable Key Modules, DATASETs, SUPERCONSOLE 1000 Attendant Console, DMP Module, and SUPERSET 7000 Attendant Consoles.

Note: The card is a high power card if a console is attached to a SX-200 LIGHT cabinet.

LS/GS Trunk Card ●

The LS/GS Trunk card is a low power card that contains six loop start or ground start trunks (jumper-selectable) and six message registration inputs. The card may be installed in any digital peripheral slot. Facilities provided by the LS/GS Trunk Card include: Loop Start or Ground Start selectable by jumper, M and MM signaling leads (refer to the feature, Meter Pulse Collection), trunk activity indicated by LED (one per trunk), transient suppression on Tip, Ring, and signaling leads, and an alarm LED.

LS/CLASS Trunk Card ●

The LS/CLASS Trunk card interfaces eight trunk circuits to the system. LS is the acronym for Loop Start and CLASS is the acronym for Custom Local Area Signaling Services (allows the system to receive calling Line ID digits and CLASS name on incoming CLASS trunks). The LS/CLASS Trunk card can be installed into slots one to eight in a SX-200 rack mount cabinet or a SX-200 ML (FD) cabinet. The card is dependant on LIGHTWARE 19 Release 2 or greater software. The LS/CLASS Trunk card provides loop start operation, forward/reverse current detectors (polarity reversal, answer supervision), alarms and trunk activity indicated by an LED (a single LED for any circuit in use), CLASS signal reception, and transient suppression on Tip and Ring leads.

Direct Inward Dial (DID) Trunk Card ■

The DID trunk card is a high power card that contains six 1-way Direct Inward Dial circuits. The DID trunk allows incoming trunk calls to dial directly to an extension within the system without attendant intervention.

Off-Premise (OPS) Line Card ●

The OPS line card is a low power card that interfaces the system to extensions which are part of the system, but are located in a different building from the PBX. It contains additional protection circuitry to protect the system from extraneous high voltages or induced currents that may appear on the line. Each OPS card has six circuits.

COV Card ■

The COV card is a high power card that is required to interface to certain voicemail applications.

Mitel Express Messenger Card ●

The Mitel Express Messenger card is a low-power card. The card uses a DNIC interface that connects directly to the backplane of the cabinet. The card provides either two, four, six, or eight voice mail ports to an SX-200 EL/ML system that has Release 1.1 software or later.

BRI Card ●

The BRI card is a low power card, although there is a maximum limit of two cards per cabinet. The card allows the SX-200 to communicate to Central Offices and devices that support BRI (Basic Rate Interface). The SX-200 supports the termination and the origination of ISDN voice and data calls for trunk side and line side U interfaces. The trunk side provides Basic Call and Incoming Calling Name. The line side provides data and voice calls from BRI devices, and voice calls from sets. The BRI card provides up to 12 ISDN BRI U interfaces.

LS/CLASS Trunk Module

The LS/CLASS Trunk module mounts in any slot of the SX-200 SPINE and interfaces four trunk circuits to the system. It includes circuitry to switch trunk circuit 1 to a SFT telephone set during power or system failure.

DNIC Module

The Digital Network Interface Circuit (DNIC) module interfaces up to four DNIC devices to the SX-200 SPINE.

ONS Line Module

The ON-Premises (ONS) line module interfaces up to four industry-standard DTMF telephone sets within the building to the SX-200 SPINE.

Digital Control and Digital Services Cards and Modules

T1 Trunk Card ■ The T1 Trunk Card is a high power card that provides an interface to one 24-channel (D4 format) T1 trunk. In an SX-200 rack mount cabinet, T1 trunk cards plug into slots 10 and 11 (slots 5 and 6 respectively must then be left vacant). Because of signal cable restrictions in an SX-200 FD cabinet, the T1 card must be positioned in slot 6. With a dual T1 adapter, two T1 trunk cards (in slots 5 and 6) are allowed.

Main Control Card

The Main Control Card (MCC) and its integral Switch Matrix perform all call processing for the entire system. The Switch Matrix is integrated into the Main Control card and includes a DX (digital crosspoint) switch. The DX array is a non-blocking array that provides bi-directional links with balanced drivers and receivers.

The main control cards are MCC IIIEL, MCC IIIELx, MCC IIIML, and MCC II. The MCC IIIELx is only available with a Stratum 3 clock. The other main control cards are available with either a Stratum 4 or a Stratum 3 clock.

Bay Control Card

The bay control card provides control of operations within the cabinet and monitors the lines, trunks and other circuits within the bay. Reports are sent to the Main Control Card via HDLC message links. One bay control card is required in each cabinet.

The bay control cards are BCC II and BCC III. The BCC III offers more processing power for the BRI cards. The BCC III also supports a DSP module (single), a T1/E1 module, and a FIM II or CIM. The T1/E1 module and the FIM II provide a cost-effective solution for T1 network connectivity for a remote system. The CIM offers extra savings for a co-located system. The DSP module supports the ONS/CLASS Line card and the Record a Call feature. The Maintenance module provides serial connectivity in a main control cabinet for BRI card maintenance, when both cards are in the main control cabinet.

Control Dual FIM Carrier Card

The Control Dual FIM Carrier card provides the interface between the MCC and the peripheral cabinets. It includes one onboard 1 km FIM and a connector for a second FIM. The Control Dual FIM Carrier connects to the backplane via slot 10 or 11 in the SX-200 EL or slot 10 in SX-200 ML (RM) Control cabinet.

Control Triple FIM Carrier Card

The Control Triple FIM Carrier card provides the interface between the MCC and the peripheral cabinets. It includes two onboard FIMs and a connector for a third FIM. The Control Triple FIM Carrier connects to the backplane via slot 10 or 11 in the SX-200 EL Control cabinet.

Three types serve our customers:

Control Triple FIM Carrier Card MM 1km - has two multi-mode 1 km FIMs onboard and a connector to plug in a third optional FIM (either a 1 km FIM or an extended FIM).

Control Triple FIM Carrier Card MM 5km - has two multi-mode 5 km FIMs onboard and a connector to plug in a third optional FIM (either a 1 km FIM or an extended FIM).

Control Triple FIM Carrier Card SM 14km - has two single mode 14 km FIMs onboard and a connector to plug in a third optional FIM (either a 1 km FIM or an extended FIM).

Control Triple CIM Card

The Control Triple CIM Card provides three onboard copper interface modules. The card also has a connector for a FIM II so that a FIM II can replace one of the CIM circuits. Any SX-200 rack-mount control cabinet supports the Control Triple CIM Card. The Control Triple CIM Card is backwards compatible for the SX-200 EL and SX-200 ML systems.

PRI Card

The PRI card provides the SX-200 EL and SX-200 ML systems with Primary Rate Access (PRA) to the ISDN service provider. The PRI card, preloaded with software, comes with a T1/E1 module that supports up to two T1 links of ISDN connectivity. The PRI card is installed in the

SX-200 ELx cabinet Rev 4.4 or greater (PN 9109-600-002-NA) with LIGHTWARE 17 Release 4.0 software or greater. The PRI card also requires a Stratum 3 clock on the main control card. The PRI card has the same performance characteristics as a two link ISDN Network Gateway. The PRI card (unlike the T1 card) is not classed as a high power card. Because the PRI card is a separate bay, the PRI card is not included in the count for the four high power cards.

FIM II

The FIM II can sit on a PRI card, BCC III, a Control Triple CIM card, or a Peripheral Interface Module Carrier card. A FIM II on a PRI card in a main control cabinet can link a peripheral cabinet to the main control cabinet. A FIM II on a PRI card in a peripheral cabinet links the PRI card bay to the main control cabinet. A FIM II is only installed on the BCC III in a peripheral cabinet; the FIM II in the BCC III connects the peripheral cabinet to the FIM or FIM II in the main control cabinet. A FIM II on a Control Triple CIM card links the main control cabinet to a peripheral cabinet. A FIM II on a Peripheral Interface Module Carrier card connects the peripheral cabinet to the main control cabinet when the peripheral cabinet does not have a BCC III to hold a FIM II. The FIM II provides fiber connectivity to the system and sits recessed back from the faceplate. The FIM II comes in three variants. The FIM II at each end of the connection must be the same variant.

T1/E1 Module

The T1/E1 module on site 2 of the PRI card provides up to two links of ISDN connectivity. The T1/E1 module on site 2 of the BCC III provides up to two T1 links. The links from the module have the same functionality as the T1 link that the T1 card provides. The SX-200 only uses the T1 type connectivity.

CIM (Copper Interface Module)

The CIM provides copper connectivity between the peripheral cabinets and the main control cabinet. The CIM is very cost effective for a system that is co-located. The CIM supports a distance of up to 30 meters or 100 feet between cabinets. The CIM has a twisted pair interface. The CIM sits on a Peripheral Interface Module Carrier card in a peripheral cabinet, on site 1 of the BCC III in a peripheral cabinet, or on site 1 of a PRI card in a main control cabinet or a peripheral cabinet. Unlike the FIM II, the CIM sits close to the faceplate and only has one variant.

DSP Module (Single)

The DSP module (single) provides 8 CLASS generators for ONS/CLASS sets and provides 16 conference bridges for Record-a-Call. The DSP module also provides 16 DTMF receivers thus eliminating the need for a Universal Card. The DSP module sits on site 3 of the BCC III.

Maintenance Module

The Maintenance module provides a serial port on the BCC III for BRI card maintenance when the BCC III and the BRI card are in the main control cabinet. A mini-DIN (cable is included) provides the connection to the PC. The Maintenance module sits on site 1 of the BCC III when the main control cabinet has a BRI card.

SX-200 Wall Mount Bracket

The SX-200 Wall Mount Bracket lets you support a single SX-200 ELx cabinet on the wall. These brackets are for the horizontal rackmount cabinet, not the vertical cabinet. The cabinet can be installed at eye level to improve working conditions. The bracket also has two push buttons that allow you to extend the cabinet away from the wall, thereby giving you plenty of room to access the back of the cabinet.

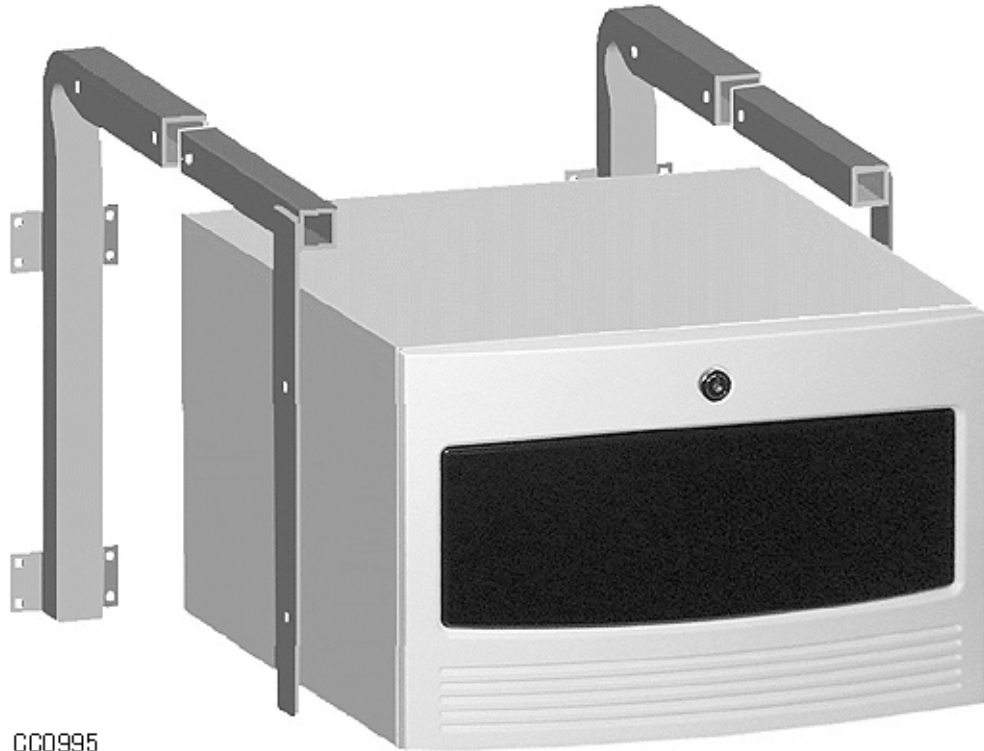

SX-200 SPINE Bay

The SX-200 SPINE is available as a single (6 slot) or dual (12 slot) configuration. Each SPINE contains one Power Module, and up to six peripheral modules. The first SPINE also contains a Control Module II (with a 1 km FIM).

The SPINE Peripheral Bay can be located up to 1 km from the control node.

Components of the SPINE include:

Control Module II - interfaces the peripheral modules with the Main Control Card in the control cabinet via its Fiber Interface Module.

Interface Modules - interface trunks and peripheral devices, such as telephones, SUPERSET telephones, and datasets, into the system.

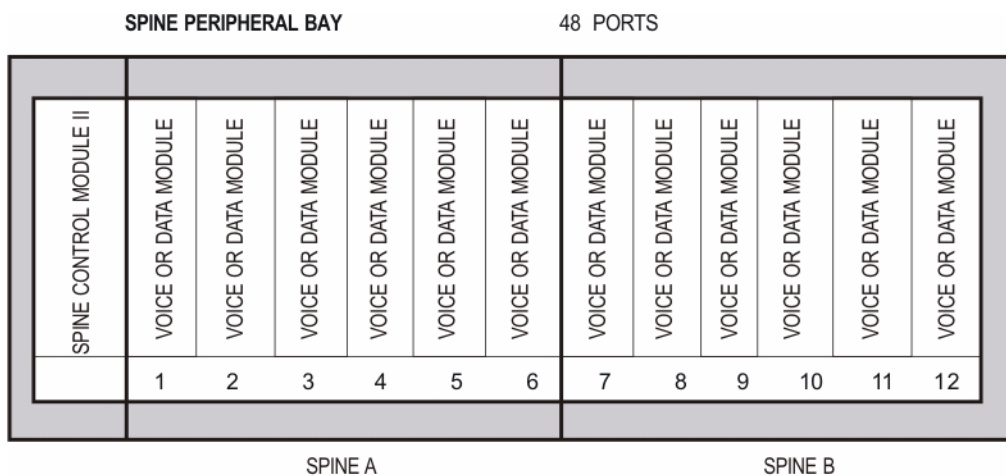

MODULES

- 4 CIRCUIT LS/CLASS MODULE
- 4 CIRCUIT ONS MODULE
- 4 CIRCUIT DNIC MODULE

CC0791b

SX-200 SPINE Configuration

SX-200 SPINE Modules

LS/CLASS Module - The LS/CLASS module mounts in any slot of the SX-200 SPINE and interfaces four trunk circuits to the system. It includes circuitry to switch trunk circuit 1 to a SFT telephone set during power or system failure.

DNIC Module - The Digital Network Interface Circuit (DNIC) module interfaces up to four DNIC devices to the SX-200 SPINE. DNIC devices include SUPERSET 4001 telephones, SUPERSET 4015 telephones, SUPERSET 4025 telephones, SUPERSET 4125 telephones, SUPERSET 4150 telephones, SUPERSET 401+ telephones, SUPERSET 410 telephones, SUPERSET 420 telephones, SUPERSET 430 telephones, Programmable Key Modules, DATASETs, SUPERCONSOLE 1000 Attendant Console, DMP Module, and SUPERSET 7000 Attendant Console.

ONS Module - The ON-Premises (ONS) line module interfaces up to four industry-standard DTMF telephone sets within the building to the SX-200 SPINE. The ONS module plugs into any slot, but each SPINE is limited to not more than three ONS modules. The ONS module does not support rotary dial telephones.

The following table provides the engineering limitations for a 48-port SX-200 SPINE bay. Spine A also contains the Control Module II.

ONS Modules installed in SPINE A or SPINE B	DNIC and/or LS/CLASS Modules Allowed	
	SPINE A	SPINE B
0	6	6
1	4	5
2	2	4
3	0	3

Power Supplies

The following identifies the power supply requirements:

Bay Power Supply

The Bay Power Supply unit is a rack-mounted AC-to-DC converter that furnishes the required operating voltages for circuit cards in the 96-port digital bays. The supply also contains a ringing voltage generator.

Power Module II

The Power Module II provides power to the SX-200 SPINE. It connects to the backplane through a 8-conductor cable located at the top of the Power Module.

Uninterruptible Power Supply (UPS)

The uninterruptible power supply (UPS) is a reserve power supply for the control cabinet and digital peripheral cabinets comprising of a battery pack, a charger, and an inverter. The UPS backup time is dependent upon the unit selected and the capacity of the batteries provided. The unit must be able to provide 115 Vac at 15 A.

Mitel Networks Corporation does not manufacture a UPS. Mitel Networks has evaluated several uninterruptible power supplies (UPS) that are compatible with the SX-200 system. Marketing and sales literature available from authorized representatives identifies these products.

The UPS should be a true uninterruptible power supply that always supplies the output load from its inverter and includes a reverse transfer switch to automatically bypass the UPS if it fails. The UPS must be capable of driving rectifier capacitor loads.

An uninterruptible power supply (UPS) can have an external connection (from an internal relay) that provides a closed contact to remotely indicate status or condition. Conditions which may be indicated include

- An alarm condition is present within the UPS
- The UPS is operating from its batteries (probably because commercial AC power has been interrupted).

The relay contact can be connected to a remote alarm or to a contact monitor line circuit to promptly indicate the condition. Refer to the manufacturer's installation manual for descriptions of conditions that are indicated. Compliance to electrical, installation, and building codes is the responsibility of the purchaser of the equipment.

System Fail Transfer

The SFT maintains telephone service in the event of system failure (such as a power outage). When the system goes into SFT mode, the SFT unit connects up to six internal POTS telephone extensions directly to the CO, bypassing the system completely.

The SFT is an optional, stand-alone, wall-mounted device that connects to the system's peripheral cabinet or main distribution frame (MDF). Each SFT can control six circuits, and up to four SFTs can be daisy-chained together for each zone, providing security for 24 internal extensions.

The SFT switches to SFT mode under the following conditions:

- Failure of the system power converter
- Failure of the system main control (in a redundant system, both main control planes must fail, causing a critical alarm to all zones)
- Interruption of the system AC power
- Failure of the peripheral switch controller (zone)
- Loss of the fiber link between the main control and peripheral cabinets.

Power Supply

All power for the SFT unit is provided from the -48 Vbat source on the system. A source of -12 V powers the electronic circuitry on the card. This supply is derived from the -48 V input and powers all the SFT circuitry except the transfer relays. The relays are powered by a transistor-regulated -41V source, also derived from the -48 Vbat input. Thus, in the event of Vbat varying between the standard -42.5 V to -56.5 V, the current drain remains constant.

Transfer Relays

Each circuit in the SFT uses a four form C relay to transfer between normal and SFT modes of operation.

Loop Detector

When a transfer relay enters SFT mode, the loop detector connects in series with the loop between the extension and CO trunk facility. This circuit prevents the extension from returning to normal operating mode before an SFT mode call is completed. When the SFT mode call is completed, the extension is returned to normal operating mode.

SFT Control Leads

The transfer control sensor on the SFT senses a loop closure across the SFT and SFT return (SFTR) leads. When a loop closure is sensed, the power to the relays is removed, the relays are released, and all circuits enter the transferred state.

Power Consumption

The total current drain for the SFT is typically 80 mA.

Power Dissipation (watts)

Power Supply	TYP. (Watts)	TYP+20%
-48Vbat	3.18	3.81
@Vbat=-56 V	3.71	4.45

Peripherals

Introduction

The SX-200 EL and the SX-200 ML systems extend their flexibility, reliability, and usability right to the desktop. Flexibility comes from the wide range of peripheral devices supported by the system. You can choose from standard telephones, IP phones, ASCII terminals and printers, modems, and proprietary peripherals.

Mitel Networks designs its peripheral devices for maximum reliability. This is evidenced by the proven performance record of each electronic telephone and dataset.

As pioneers in the world of sophisticated telephone instruments, Mitel Networks ensures the usability of its sets by fully integrating the sets with the features available on the system. Usability is further enhanced through multiline sets, softkeys with context-sensitive visual prompts, and message displays.

Mitel Networks 5000 Series IP Phones

Mitel Networks 5010 IP Phone

The Mitel Networks 5010 IP Phone connects to a 10/100BaseT Ethernet network. Features of the telephone include

- Twenty-character alpha-numeric liquid crystal display (LCD)
- Seven line keys, each with a built-in line status indicator
- Six fixed-function keys: SuperKey, Cancel, Hold, Redial, Transfer/Conference, and Message
- Automatic selection of prime line or ringing line
- Key selection of non-prime line
- Handset and ringer volume controls (Up Arrow and Down Arrow)
- Ringer pitch control
- Message Waiting lamp
- Dual Ethernet port to provide connectivity to the LAN for both your telephone and computer
- Dedicated Headset port.



LL0029

Mitel Networks 5010 IP Phone

Mitel Networks 5020 IP Phone

The Mitel Networks 5020 IP Phone connects to a 10/100BaseT Ethernet network. Features of the phone include

- Twenty-character alpha-numeric LCD with contrast control
- Three softkeys for feature access
- Fourteen line keys, each with a built-in line status indicator
- Eight fixed-function keys: SuperKey, Cancel, Hold, Redial, Transfer/Conference, Message, Microphone, and Speaker
- Automatic selection of prime line
- Key selection of non-prime line
- Handsfree operation (half-duplex)
- Handset, speaker, and ringer volume controls (Up Arrow and Down Arrow)
- Ringer pitch control
- Message waiting lamp
- Dual Ethernet port to provide connectivity to the LAN for both your telephone and computer
- Dedicated Headset port.



LL0030

Mitel Networks 5020 IP Phone

Mitel Networks 5215 IP Phone

The Mitel Networks 5215 IP Phone connects to a 10/100BaseT Ethernet network. Features of the phone include

- Alpha-numeric LCD
- Seven line keys, each with a built-in line status indicator
- Eight fixed-function keys: SuperKey, Cancel, Hold, Redial, Transfer/Conference, Message, Up Arrow, and Down Arrow
- Automatic selection of prime line or ringing line
- Key selection of non-prime line
- Handset and ringer volume control
- Ringer pitch control
- Message Waiting lamp
- Headset port
- Adjustable tilt mechanism.



NN0003

Mitel Networks 5215 IP Phone

Mitel Networks 5220 IP Phone

The Mitel Networks 5220 IP Phone connects to a 10/100BaseT Ethernet network. Features of the phone include

- Alpha-numeric LCD with contrast control
- Three softkeys for feature access
- Fourteen line keys, each with a built-in line status indicator
- Ten fixed-function keys: SuperKey, Cancel, Hold, Redial, Transfer/Conference, Message, Microphone, Speaker, Up Arrow, and Down Arrow
- Automatic selection of prime line
- Key selection of non-prime line
- Handsfree operation, group listening, and off-hook voice announce
- Handset, speaker, and ringer volume controls
- Ringer pitch control
- Message Waiting lamp
- Headset port
- Adjustable tilt mechanism.



NN0004

Mitel Networks 5220 IP Phone

Mitel Networks 5305 IP Office Conference Unit

The Mitel Networks 5305 IP Office Conference Unit is a high-quality conference unit that uses acoustic beam-forming technology to ensure superior performance. The unit is used in conjunction with the 5020 IP Phone and connects to the phone's headset port. This unit is designed for optimal performance in a private office that measures 12 feet by 15 feet (3.6 meters by 4.5 meters).

Features of the conference unit include

- Full Duplex operation
- Acoustic beam-forming technology that controls near end, far end, and double talk, and also locates direction of speech
- Noise reduction and automatic gain control to eliminate background noise
- High-fidelity speaker
- Power supply from a 24 V wall adapter
- Simple installation
- Side Control Unit with **Mute**, **Hold**, and **Volume** controls.

The 5305 IP Conference Unit package includes a speaker unit and a side control unit. An optional mouse controller is available.



LL0027

Mitel Networks 5305 IP Office Conference Unit

Mitel Networks 5310 IP Board Room Conference Unit

The Mitel Networks 5310 IP Board Room Conference Unit is a high quality conference unit that uses acoustic beam-forming technology to ensure superior performance. The unit is used in conjunction with the 5020 IP Phone and connects to the phone through the phone's headset port. This unit is designed for optimal performance in a room that measures 15 feet by 25 feet (4.5 meters by 7.6 meters).

Features of the conference unit include

- Full Duplex operation
- Acoustic beam-forming technology that controls near end, far end, and double talk, and also locates direction of speech
- Noise reduction and automatic gain control to eliminate background noise
- High-fidelity speaker
- Directional and Presentation Modes
- Dual color LEDs (7 on the unit, in total) for visual confirmation the unit has picked up the speaker's voice
- Power supply from a 24 V wall adapter
- Simple installation
- Side Control Unit with **Mute**, **Hold**, and **Volume** controls

The 5310 IP Conference Unit package includes a 5020 IP Phone, a speaker unit, and a side control unit. An optional mouse controller is available.



Mitel Networks 5310 IP Board Room Conference Unit and 5020 IP Phone

Attendant Consoles

At the heart of the SX-200 telephone system is the Attendant Console - a practical, multi-use tool that simplifies communications management in your organization.

For the Attendant, operating simplicity, innovative design, and elegant styling translate into an easy-to-read liquid crystal display, hardkeys for the most often performed functions, and softkeys for situation-dependent features, all contained in a compact package.

The Console can also be used as an economical option for a department secretary handling calls for a group of people, a maintenance console for troubleshooting, report generation and traffic measurement, and a programming console for customer data entry.

Attendant/Secretarial. The console's four-line, 80-character liquid crystal display (LCD) shows time and date, and call status information including the names of callers within your organization, call source and destination, and number of calls waiting to be answered. The 14 hardkeys are dedicated to standard attendant activities - answering calls, putting calls on hold, blocking calls, paging, releasing calls to their destination or hanging up, canceling dialed digits, checking the status of trunk groups, and performing Attendant functions such as setting time and date, and switching to night service. Ten softkeys control access to the attendant features through blank keys on the console. The name of the feature associated with a particular key is shown on the screen only when it is available for use.

Maintenance. All maintenance activities - system level functions (such as setting time and date, printer port status reporting, and monitoring diagnostics), reporting functions such as configuration, alarm status, and the display and clearance of device errors), maintenance log functions, diagnostic functions, and traffic measurement - can be done through a Console. When the Console is being used as a maintenance console, the softkeys displayed are the ones available on a maintenance terminal. Maintenance access is password controlled.

Customer Data Entry. All Customer Data Entry (CDE) - initial system installation, moves, adds and changes, and system expansion - can be done through the Console. When the Console is being used as a CDE Console, programming is done by softkeys. As in maintenance, access to CDE is password-controlled.

System Consoles are available in two models - the SUPERCONSOLE 1000 Console and the SUPERSET 7000 Console. Both models support:

- Up to nine line appearances
- Eight call hold positions
- English, French, and Spanish operation
- Two headset jacks.

The SUPERCONSOLE 1000 can directly connect two PKM 48 devices and has two blank keys on the console that are available for programming as macro keys. A macro is a series of keystrokes that you assign to a single key. Instead of repeating the keystrokes each time you want to perform a task, you can press the macro key to execute all the keystrokes at once. Macro keys may be used for transferring calls to voicemail, for recovering calls released to the wrong extension, or for one-button dialing of frequently called telephone numbers. If the user desires more than two macro keys, the user can reprogram the Trunk Group key and the Set Page key as a macro key.

Up to 11 consoles can be connected to the SX-200 system.

SUPERCONSOLE 1000 Attendant Console

The SUPERCONSOLE 1000 Attendant Console uses a standard twisted-pair telephone wire to interface to a DNIC circuit. The Console has a tilt display and two blank firmkeys for programming macros. The console supports up to two PKM 48 devices and has an RS-232C port for connecting an ASCII line printer.

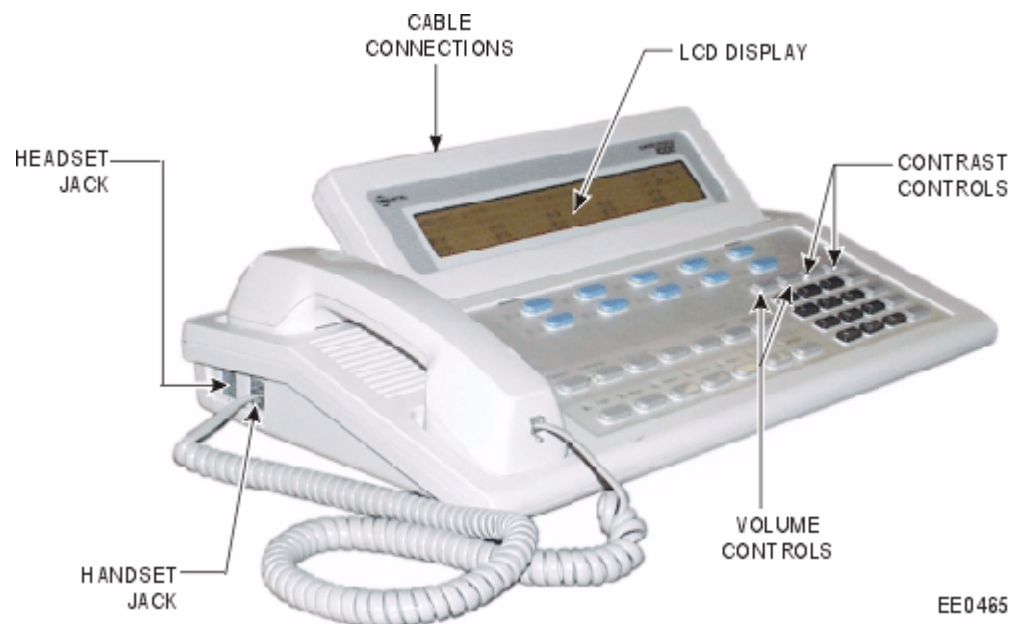

SUPERCONSOLE 1000 Attendant Console

SUPERSET 7000 Attendant Console

The SUPERSET 7000 Attendant Console is a DOS and Windows™ based application running on a PC. It is equipped with a MITEL PC TALK TO® card, a SUPERSET 400 series handset, an extended keyboard, and a handset cradle. The PC TALK TO card uses a standard DNIC interface to communicate to the SX-200 EL/ML system. Features such as call handling, telephone directory with user status, and trunk labeling, run on the SUPERSET 7000 attendant console. The SUPERSET 7000 attendant console performs call handling functions and is similar to the SUPERCONSOLE 1000. The SUPERSET 7000 is not intended to function as a primary console. The SUPERSET 7000 functions as a secondary console.

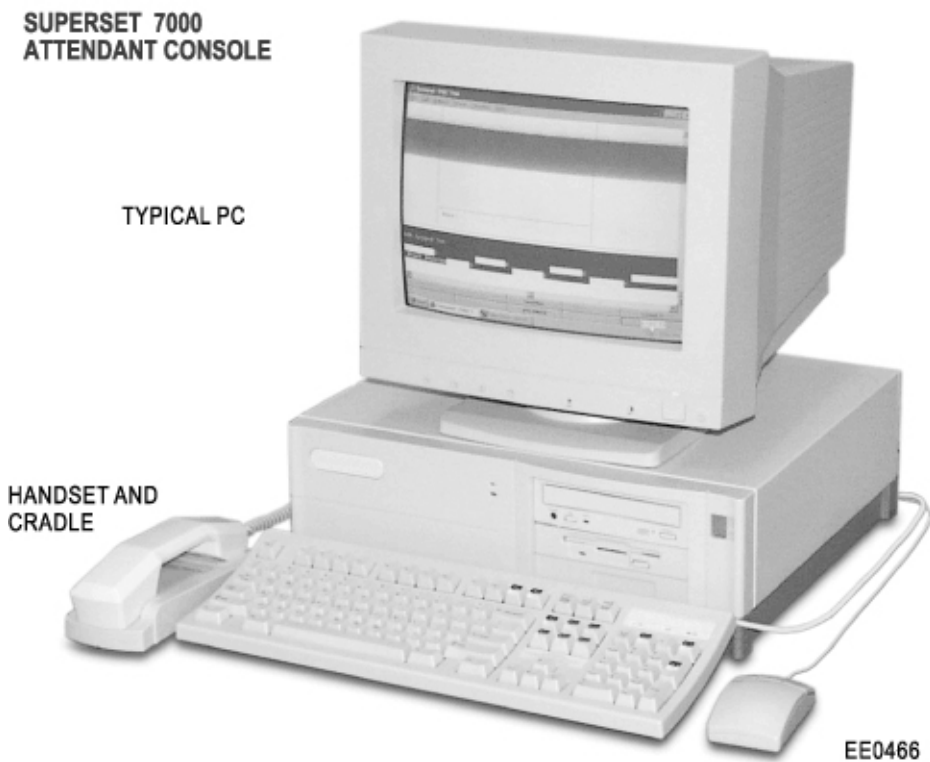

SUPERSET 7000 Attendant Console

SUPERSET 4000 Series Telephones

There are five SUPERSET 4000 series telephone sets:

- SUPERSET 4001 single-line telephone set
- SUPERSET 4015 multi-line telephone set with a LCD display
- SUPERSET 4025 multi-line telephone set with an enhanced LCD display
- SUPERSET 4090 two line, cordless telephone set with a LCD display
- SUPERSET 4125 multi-line telephone set with a backlit,enhanced LCD display and a built-in RS-232 interface
- SUPERSET 4150 multi-line telephone set with a backlit, touch-sensitive LCD display and a built-in RS-232 interface.

Note: The SUPERSET 400 series telephones have been discontinued, however they are still supported by the SX-200 system.

The SUPERSET 4000 Series telephone set features are described below.

Note: The SUPERSET 4090 does not have the following keys but has many of the functions described below.

Line Keys

During Customer Data Entry, a line key may be programmed as a line appearance key, Speed Call key, direct trunk access key, multicall key, personal outgoing trunk key, or feature key.

Speed Call Keys

Program a Speed Call key on the SUPERSET 4001 telephone set to automatically dial a telephone number.

SuperKey

Use the Superkey to program line keys as feature keys or Speed Call keys. Program Name, reminder, messaging, call forwarding, calculator, ringer adjust, clean LCD, select a display language, and display programmed keys from SuperKey.

Program Key

On the SUPERSET 4001 telephone set only, use the Program key to assign a telephone number to a Speed Call key.

Flash Key

Use the Flash key on the SUPERSET 4001 telephone for feature access.

Hold Key

Press the Hold key to place your call on Hold.

To retrieve a call from Hold on the SUPERSET 4001 telephone set, press the Hold key again.

To retrieve a call from Hold on a multi-line telephone set, press the line key of the line on Hold.

Microphone key

During a handsfree call, press the Microphone key to mute the microphone. Press the Microphone key again to turn muting off. The indicator lamp built into the Microphone is on when the microphone on.

Speaker key

During a call, press the Speaker key to switch from handset mode to handsfree mode. To return to handset mode, press the Speaker key again.

Softkeys

When you press the SuperKey, the softkeys provide programming functions. The function of each softkey is defined by its corresponding field on the LCD. On the SUPERSET 4150 telephone set, the softkeys are touch-sensitive areas of the LCD. The SUPERSET 4150 telephone offers full-duplex speaker-phone functionality.

Liquid Crystal Display (LCD)

The LCD displays

- Time and date while the telephone set is idle
- Softkey labels during programming and feature access
- Call status during telephone calls
- Message information
- System status messages.

To adjust the LCD contrast, press the Up Arrow and Down Arrow keys while the set is idle.

Message Waiting Lamp

The Message Waiting Lamp flashes when another telephone set has left you a Callback message. The Message Lamp is on when you call a telephone that is capable of receiving a Callback message.

Handset, Speaker, and Ringer Volume Control

The user can adjust handset, speaker, and ringer volume.

Ringer Pitch Control

The user can adjust ringer pitch.

Line Status Indicators

The SUPERSET 4000 multi-line telephone set has each line key with a built-in line status indicator.

Headset Port

SUPERSET 4000 series telephones, except for the SUPERSET 4001, have a headset port on the base of the set.

SUPERSET 4001 Telephone

The SUPERSET 4001 telephone is a single-line, digital telephone set with

- Seven **Speed Call** keys
- Six fixed-function keys: **Program**, **Hold**, **Flash**, **Message**, **Up Arrow**, and **Down Arrow**
- Handset and ringer volume control
- Ringer pitch control
- Message Waiting lamp
- Adjustable tilt mechanism.



SUPERSET 4001 Telephone

SUPERSET 4015 Telephone

The SUPERSET 4015 is a multiline, digital telephone set with

- Alpha-numeric LCD
- Seven line keys, each with a built-in line status indicator
- Eight fixed-function keys: **SuperKey**, **Cancel**, **Hold**, **Redial**, **Transfer/Conference**, **Message**, **Up Arrow**, and **Down Arrow**
- Automatic selection of prime line or ringing line
- Key selection of non-prime line
- Handset and ringer volume control
- Ringer pitch control
- Message Waiting lamp
- Headset port
- Adjustable tilt mechanism.



SUPERSET 4015 Telephone

SUPERSET 4025 Telephone

The SUPERSET 4025 telephone is a multi-line, digital telephone set that comes in two versions (non-backlit and backlit). The backlit version offers backlighting in the LCD, thereby increasing visibility in dimly lit environments. The backlighting of the SUPERSET 4025 telephone is line powered, so there is no requirement for an AC Power Adapter. Both versions have the following features:

- Alpha-numeric LCD with contrast control
- Three softkeys for feature access
- Fourteen line keys, each with a built-in line status indicator
- Ten fixed-function keys: **SuperKey**, **Cancel**, **Hold**, **Redial**, **Transfer/Conference**, **Message**, **Microphone**, **Speaker**, **Up Arrow**, and **Down Arrow**
- Automatic selection of prime line
- Key selection of non-prime line
- Handsfree operation, group listening, and off-hook voice announce
- Handset, speaker, and ringer volume controls
- Ringer pitch control
- Message Waiting lamp
- Headset port
- Adjustable tilt mechanism.



SUPERSET 4025 Telephone

SUPERSET 4090 Telephone

The SUPERSET 4090 is a digital cordless telephone equipped with a backup battery charging unit and a base unit.

The SUPERSET 4090 cordless can be used as a primary set or with another SUPERSET 4000 series desk phone. You can set up Call Forward on the desk phone to send calls to the SUPERSET 4090 when you are away from your desk. You can also use a line appearance key on the SUPERSET 4090 to answer calls to the prime line on your desk phone.

The SUPERSET 4090 provides the following features:

- Ten fixed-function keys (**TALK**, **CHAN**, **VOL**, **HOLD**, **MSG**, **LINE 1**, **FN**, **CANCEL**, **TR/CNF**, and **MUTE**) and an extra personal key that you program for call forwarding or speed dialing
- Programming for **Speed Dial** keys and Language Selection
- A ringer on/off switch
- Status indicators for Talk, Battery level, and Lock
- Line status indicators on the two personal keys
- A 2x16 character display
- A headset port.



SUPERSET 4090 Telephone

SUPERSET 4125 Telephone

The SUPERSET 4125 is similar to the SUPERSET 4025. The difference between the two is the ability of the SUPERSET 4125 to connect to a PC. The SUPERSET 4125 comes with MITEL TAPI Desktop software, an AC power adapter, and a RS-232 cable. The SUPERSET 4125 is a multiline, digital telephone with

- Alpha-numeric, 2 line by 20 character, backlit, and LCD with contrast control
- Three softkeys for feature access
- Fourteen line keys, each with a built-in line status indicator
- Ten fixed-function keys: **SuperKey, Cancel, Hold, Redial, Transfer/Conference, Message, Microphone, Speaker, Up Arrow, and Down Arrow**
- Built-in RS-232 interface
- Automatic selection of prime line
- Key selection of non-prime line
- Handsfree operation
- Handset, speaker, and ringer volume controls
- Ringer pitch control
- Message Waiting lamp
- Dedicated headset port
- Adjustable tilt mechanism.



ES0010

SUPERSET 4125 Telephone

SUPERSET 4150 Telephone

The SUPERSET 4150 is a multiline, digital telephone set with

- Alpha-numeric, 4 line by 40 character, backlit LCD with contrast control
- Six touch-sensitive softkey areas for feature access on the LCD
- Fourteen line keys, each with a built-in line status indicator
- Six fixed-function keys: **SuperKey**, **Hold**, **Microphone**, **Speaker**, **Up Arrow**, and **Down Arrow**
- Automatic selection of prime line
- Key selection of non-prime line
- Handsfree operation, group listening, and off-hook voice announce
- Handset, speaker, and ringer volume control
- Ringer pitch control
- Message Waiting lamp
- Headset port
- Full duplex speaker phone functionality
- Adjustable tilt mechanism.

Note: The AC power adapter provides the power for the LCD backlighting and the full handsfree feature. If the AC power adapter is not used, or if the AC power is cut off, the SUPERSET 4150 backlit telephone will resort back to a standard LCD display for the LCD and have half of the duplex handsfree capability.



ES0011

SUPERSET 4150 Telephone

Programmable Key Modules

Mitel Networks 5410 Programmable Key Module

The Mitel Networks 5410 Programmable Key Module provides 12 additional personal keys for a 5020 IP Phone. They can be programmed as **Feature** keys, **Speed Call** keys, **Direct Station Select** keys, or **Line Appearance** keys. Each key has a Line Status Indicator that works the same way as those on the associated phone.

The 5410 PKM unit connects to a 5020 IP Phone through a Mitel Networks PKM Interface Module (IM). The PKM IM is installed separately at the base of telephone and is only compatible with 5020 IP Phones.



Mitel Networks 5140 Programmable Key Module

Mitel Networks 5415 Programmable Key Module

The Mitel Networks 5415 Programmable Key Module provides 48 additional feature keys for a 5020 IP Phone. They can be programmed as **Feature** keys, **Speed Call** keys, **Direct Station Select** keys, or **Line Appearance** keys. Each key has a Line Status Indicator that works the same way as those on the associated telephone. The keys can be programmed through the telephone.

The 5415 PKM unit connects to a 5020 IP Phone through a Mitel Networks PKM Interface Module (IM). The PKM IM is installed separately at the base of telephone and is only compatible with 5020 IP Phones.



LL0035

Mitel Networks 5415 Programmable Key Module

Mitel Networks Programmable Key Module 12

The Mitel Networks Programmable Key Module 12 (PKM 12) is a digital device which provides 12 additional personal keys for SUPERSET 4025, SUPERSET 4125 and SUPERSET 4150 telephones. The personal keys provide the same functionality as the Mitel Networks Programmable Key Module 48 personal keys. The keys can be programmed as

- **Speed Call** keys
- **Feature** keys
- **Line Appearance** keys
- Personal outgoing line keys
- Key system appearances
- Multi-call line appearances
- CO line keys
- Busy lamp field/direct station select keys.

Each personal key has a Line Status Indicator that behaves the same as the indicators on the SUPERSET 4000 series telephones.

The Mitel Networks Programmable Key Module 12 connects to a SUPERSET 4000 series telephone using the included modular cable, and a SUPERSET Interface Module (SIM1 or SIM2) installed in the set. The module supplies power to the PKM 12.

Note: The PKM 12 and PKM 48 are the only programmable key modules qualified by Mitel Networks for connection to SUPERSET 4000 series telephones. The PKM 12 is not designed to connect to a PKM 12 or PKM 48.



ES0123

Mitel Networks Programmable Key Module 12 with Telephone

Mitel Networks Programmable Key Module 48

The Mitel Networks Programmable Key Module 48 (PKM 48) provides SUPERSET 4025, SUPERSET 4125, SUPERSET 4150 telephones, and attendant consoles with 48 additional personal keys; 96 additional keys when two PKM 48 devices are daisy-chained. The SUPERSET telephone requires a SUPERSET Interface Module (SIM1 or SIM2) in its base to interface to the PKM 48. The attendant console requires a DSS/BLF Interface unit, page 87. When an attendant console has a DSS/BLF interface unit associated with it, only busy lamp field/direct trunk select keys can be programmed. When a PKM 48 is associated with a set, the keys can be programmed with the following functions:

- Speed call keys
- Feature keys
- Key line appearances
- Personal outgoing line keys
- Key system appearances
- Multi-call line appearances
- CO line keys
- Busy lamp field/direct station select keys.

The flash rates for the Line Status Displays on the PKM 48 are identical to those on the SUPERSET telephones. Keys are arranged in four vertical rows on the module. Beside each key is a Line Status Display that indicates the status of the key.

Up to two PKM 48 devices connect with the attendant console or SUPERSET telephone. The PKM 48 has the same adjustable tilt mechanism as the SUPERSET telephone. You must plug the mounting brackets to connect the PKM 48 to the SUPERSET telephone. The first PKM 48 connects to the port located on the base of the set. The second PKM 48 connects to the first PKM 48.

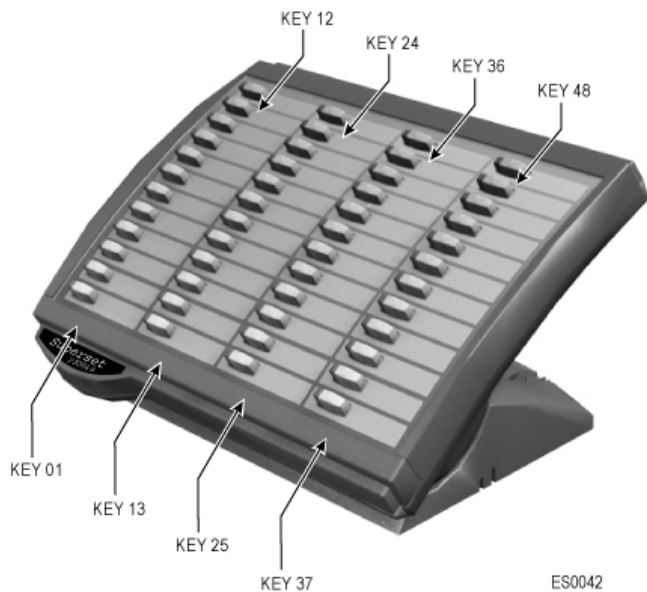

Mitel Networks Programmable Key Module 48

Interface Modules

SUPERSET Interface Module 1

A SUPERSET Interface Module (SIM1) is installed in a SUPERSET 4025, SUPERSET 4125, or SUPERSET 4150 telephone to connect a Mitel Networks Programmable Key Module 12 or up to two Mitel Networks Programmable Key Module 48 devices.



ES0039

SUPERSET Interface Module 1 (SIM 1)

SUPERSET Interface Module 2

The SUPERSET Interface Module (SIM2) allows the connection of one Mitel Networks 5410 Programmable Key Module or up to two Mitel Networks 5415 Programmable key Modules and one two-wire analog device such as an analog telephone, fax machine, or modem (to a maximum loop length of 50 feet and a ringer load of up to 2 REN). This interface module allows simultaneous use of both the SUPERSET 4000 series telephone and the analog peripheral.

The SUPERSET 4025 and the SUPERSET 4125 telephone require a power adaptor for the interface module connection. A power adaptor comes with the SUPERSET 4150 telephone but must be ordered if the PKM 48 or PKM 12 is to go on a SUPERSET 4025 or a SUPERSET 4125 telephone.

Message Waiting is not supported by sets connected to a SIM2. Devices with a Z-type REN are not to be connected to a SIM2. The analog device must signal using DTMF tones; devices that use dial pulse signaling are not supported.

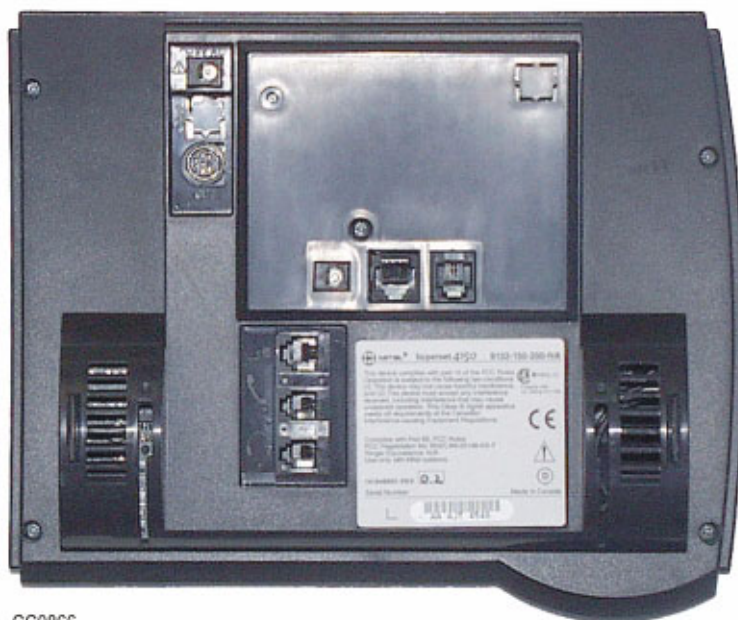

SUPERSET Interface Module 2 in a SUPERSET 4150 Telephone

DSS/BLF Interface Unit

The Direct Station Select/Busy Lamp Field (DSS/BLF) Interface Unit allows you to associate up to two Mitel Networks Programmable Key Module 48 devices with an attendant console. Each PKM 48 provides the attendant console user with 48 DSS/BLF keys (busy lamp field appearance keys for the associated extension numbers).

The DSS/BLF Interface Unit uses a separate line connection to a DNIC port. You attach the PKM 48 devices to the DSS/BLF Interface Unit and associate the PKM 48 devices with the attendant console through Customer Data Entry (CDE).



DSS/BLF Interface Unit

Music-On-Hold/Pager Unit (DMP)

The Music-On-Hold/Pager unit interfaces a standard SX-200 ML DNIC port to the following external equipment:

- External music source for Music-on-Hold
- External paging amplifier (with or without answerback capability)
- Up to two night bells
- An external alarm

The unit is powered by the SX-200 ML system and does not require a separate power source. A single 25 pair amphenol connects to the SX-200 ML system via the main distribution frame. A single LED indicator provides basic status information. The unit can be wall-mounted next to the SX-200 ML system.

Each Music-on-Hold/Pager Unit supports a single paging zone. If more than one paging zone is required, additional Music-on-Hold/Pager Units can be added as required.



Music-On-Hold/Pager Unit

Datasets

Mitel Networks datasets are proprietary limited-distance modems that provide data facilities for terminals, digital SUPERSET telephones, and other types of data devices. These datasets serve as the interface between the DNIC circuit in the PBX, and the data devices connected to the system, transmitting data and control signals over a single twisted pair of wires. The datasets are available in three series - DATASET 1100 series, DATASET 2100 series and the MILINK Data Module.

DATASET 1100 series supports asynchronous data communications at rates from 110 bps to 19.2 kbps. The datasets are RS-232C compatible, and provide end-to-end error correction, auto-baud detection and auto-parity generation.

DATASET 2100 series supports asynchronous data communications from 110 bps to 19.2 kbps, and synchronous data communications at rates from 1200 bps to 19.2 kbps. In asynchronous mode these datasets have the same operating characteristics as the DATASET 1100 series. In synchronous mode, the DATASET 2100 series uses X.31 protocol.

The DATASET 1100 series is available as

- DATASET 1103 Standalone.

The DATASET 2100 series is available as

- DATASET 2103 Standalone.

The DATASET 1100 and 2100 series of datasets interface to a PBX DNIC circuit through a single pair.

The MILINK Data Module is a limited distance, asynchronous, digital dataset. It converts data signals from such RS-232 serial devices as computers or display terminals, to high-speed digital signals. This conversion allows for peripheral interface with the SX-200 EL and SX-200 ML systems.

The MILINK Data Module is a desktop unit which can be positioned under or beside a SUPERSET 410, SUPERSET 420 or SUPERSET 430 telephone and connected to a modular jack at the base of the telephone. The 2-pair cable that connects the SUPERSET telephone to the switch, carries both voice and data signals, allowing the use of an RS-232 device and the SUPERSET telephone simultaneously.

DATASET 1103 Standalone

The standalone DATASET 1103 is packaged in a flat case which can be placed under a standard desk telephone set. It is used to interface a terminal, personal computer, or other peripheral device for connection to a host computer.

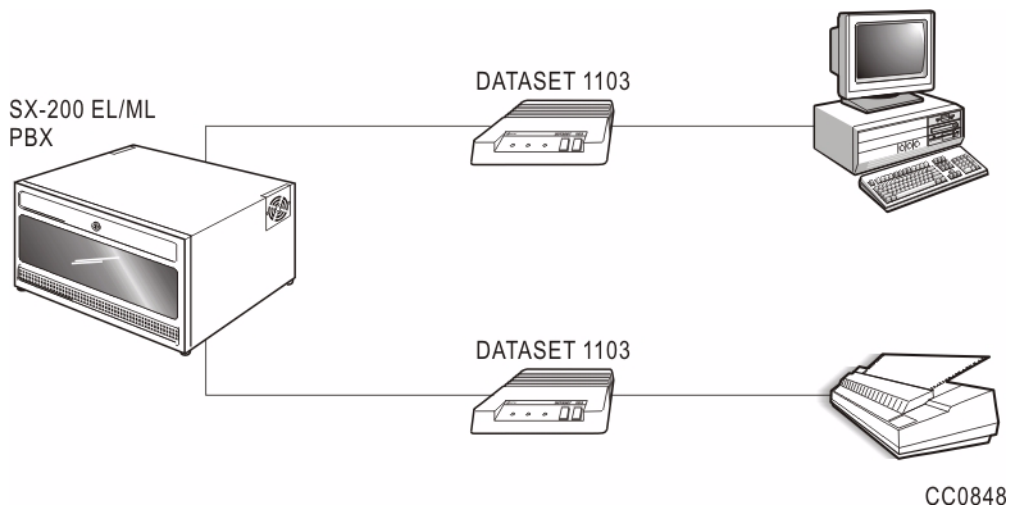

DATASET 1103 - Typical Application

DATASET 2103 Standalone

The standalone DATASET 2103 is a synchronous/asynchronous dataset which is used to interface peripheral data devices to the SX-200 EL and SX-200 ML systems. It is packaged in a flat case that can be placed under a standard desk telephone.

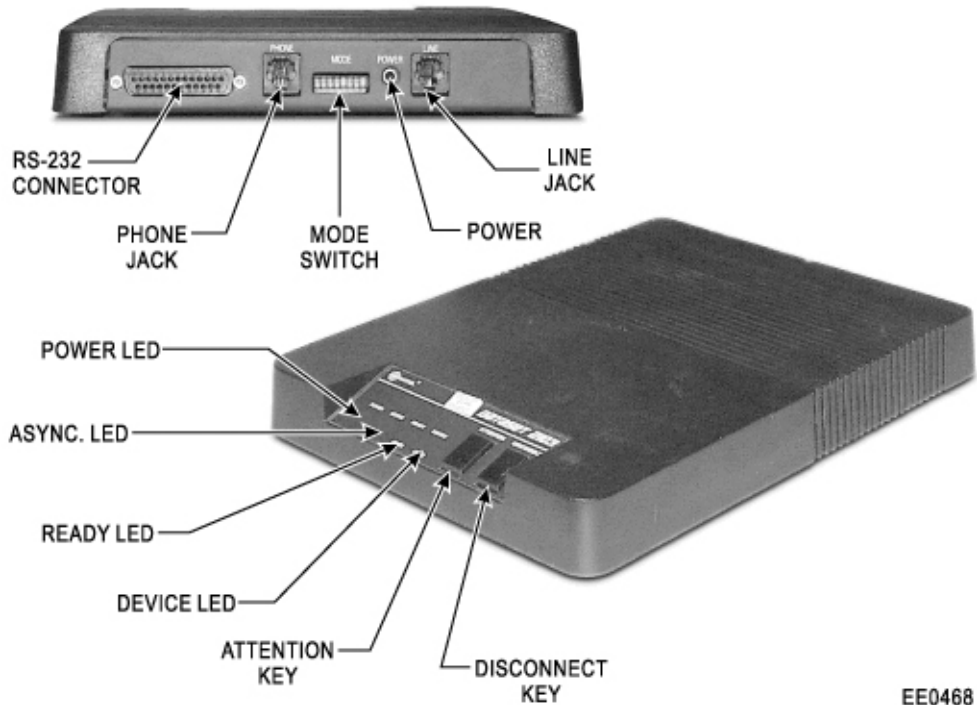

EE0468

Dataset 2103 Standalone

SMART-1® Devices

The SMART-1 device is a Programmable Communication Controller (PCC). It can be installed at your site to allow your telephone system to access the telephone company's "Other Common Carrier (OCC)/Reseller's Network". OCC facilities are usually less expensive than direct distance dialing for long distance calls.

The SMART-1 device does all the routing and exception searches to complete the call on less costly carriers. Each unit has an RS-232C Station Message Detail Recording (SMDR) output. The SMART-1 device is available in four-, two-, and one-line capabilities.

The most popular controller is the Positive Account Verification Controller. This call controller has the capability of positive account code verification, 1000 speed call numbers, and the ability to be chained together. Chaining provides a single output of Station Message Detail records with up to 10 units.



EE0470

SMART-1 Device

Digital Line Monitor (DLM)

The Digital Line Monitor (DLM) is an interface used to record voice information from Mitel Networks DNIC-based digital telephones or consoles on an externally connected tape recorder (not included). The unit records calls from the associated telephone only. The unit is free standing and can be located on a desk or elsewhere within the building. The DLM is designed so that a SUPERSET telephone can be placed on top of it if desired.



CC0921

Digital Line Monitor

MITEL Express Messenger Voice Mail

MITEL Express Messenger allows a single voice mail card to provide either two, four, six or eight voice mail ports to a system operating with LIGHTWARE 17 or greater software.

After a call is forwarded to voice mail from an extension, the caller's calling line identification (CLID) and the forwarding extension number are passed to the Express Messenger system.

Mitel Express Messenger supports English (North American), French (North American), and Spanish (North American). Spanish prompts are supported with MEM Release 2.1 or greater. French prompts are supported with MEM Release 3.0 or greater.

Mitel Express Messenger supports Record a Call. This feature allows the user to record an internal or external two-party conversation at their set. The recording process can start automatically or manually.

Auto Attendant Features

Open and Closed Greetings: The company greeting can be programmed to automatically change from open business hours to closed or after hours.

Temporary Greeting: A Company Greeting can be programmed for use over holidays or shutdowns that will automatically expire after a specified number of days.

Alternate Greetings: Each port can use one of eight alternate greeting sets (Open, Closed, or Temporary) to allow special greetings per port. This feature is useful in multi-tenant configurations.

Control Call Answer Time By Port: The number of rings to wait before the Auto-Attendant will answer can be controlled on a port-by-port basis, including immediate and never answer.

Flexible Mailbox Numbering (Dial plan): In addition to supporting single-digit mailboxes (1 - 8), a mailbox dial plan of 2, 3, or 4 digits can be selected.

Directory: Also known as Name Dialing. Callers may access a mailbox directory where they will be able to reach a mailbox owner by dialing the person's first or last name rather than their mailbox number. The system can be configured for either first or last name dialing (but not both at the same time).

Caller Type-Ahead: Callers who are familiar with the system may enter their key pad selections without waiting for the system prompts.

Operator Revert: Callers may reach a live attendant at any time by dialing "0".

Fax Finder: Detects an incoming fax tone and directs it to the fax mailbox/extension.

Operator Transfer to a Mailbox: Allows an operator to transfer an outside caller to a specified mailbox where the caller will immediately hear the subscriber's personal greeting and will be prompted to leave a message.

Quick Message Feature: Allows a caller reaching the auto-attendant to leave a message in a specific mailbox without transferring to the mailbox extension and possibly speaking live with the subscriber.

Multiple Message Capability: Allows an outside caller to leave more than one voice mail message per call, therefore saving on toll charges.

Transfer to Any PBX Extension: Allows the user to dial any internal extension defined in the PBX.

User Programmable Dial 0 Extension: Allows the user to program the dial 0 extension to any internal extension, for example, a personal or departmental secretary. The administrator can override the system default ("0" for the operator) with any valid phone number, including an external number or even a long distance number. The administrator can also override the system default on an extension by extension basis, with any valid phone number.

Voice Mail Features

Personal Greetings/Name: Subscriber name and a personal greeting can be recorded by each mailbox user.

Temporary Greeting: A personal greeting set for a specific number of days (with automatic expiration) can be recorded by each subscriber.

Password Protected Mailboxes: Access to subscriber mailboxes requires a password.

Message Envelope: Played prior to beginning of each message, containing priority type, date, and time (including caller identification for internal and external calls).

Message Length: Unlimited message length with a 5 minute continuation prompt.

Saved Messages: Messages may be saved by a subscriber. They will be automatically purged from the system after 15 days (or as reprogrammed) or you can specify that saved messages are never deleted. New messages are never purged automatically.

Message Review: Allows immediate replay of a message, including message envelope (timestamp, calling party information). The saved messages are played in last-in first played order.

Message Erase: Allows immediate deletion of a message from the system. The message cannot be subsequently restored; deletion is immediate and permanent.

Message Reply: Allows immediate reply to a message received from another internal mailbox subscriber.

Message Forward: Allows messages to be forwarded to other subscribers and distribution lists with or without a pre-pended comment.

Message Rewind/Hold/Fast Forward: Allows subscribers to rewind, fast forward, or pause messages for several seconds.

Music on Hold: Provides the ability to mimic a RAD.

Urgent Messages: The message receives priority placement in the listener's mailbox.

Private Messages: The message cannot be forwarded to another subscriber's mailbox.

Certified Messages: On internal calls, the sender will be notified when the recipient has read the message.

Message Send Actions: Callers will have the ability to review, re-record, and append to a message before sending it. A message can also be cancelled prior to sending.

Memo: Subscribers will have single-digit access to send a message to their own mailbox, for future reminders and memo-type messaging.

Message Notification: The subscriber will be notified that they have received a message by the message light on their phone (MWI), and optionally by setting the notification type to one of the following options, which will cause Express Messenger to call

- The mailbox's associated extension number, for analog phone extensions or phones without a message light (prompts called party to log into their mailbox)
- An outside number (prompts called party to log into their mailbox)
- A message pager (plays an audio message indicating messages are waiting)
- A tone-only pager (simply hangs up after a far connection is made)
- A digital pager (plays DTMF digits corresponding to a system-wide callback number along with the specific mailbox number).

Notification options may be changed by the system administrator. They may also be modified by the mailbox owner if permission is granted by the system administrator. In addition to the notification type, the phone number and schedule are configurable. The schedule determines whether paging occurs

- Around the clock, regardless of the business schedule
- Only during open business hours
- Only during closed business hours
- Never (disabled until the schedule is changed to one of the three previous schedule options).

Finally, a mailbox may be configured to do non-MWI notification only in response to urgent messages (as opposed to all messages).

By default, a busy or no answer condition detected on a notification call will result in two additional retries occurring at 15 minute intervals. All notification results are posted to the system log file.

Outside Message Notification Calls: The administrator will configure a trunk access code for use in all outside notification calls. The trunk access code will control the lines to be used for notification.

Distribution Lists, Broadcast Message: Allows four system-wide and five (per mailbox) personal distribution lists as well as a broadcast message facility to deliver a message to all mailboxes.

New mailbox Tutorial: The system will guide the user through the steps required for initial configuration of mailbox, including specification of a (non-default) passcode and recording of a personal greeting and name.

Mailbox Types: Four mailbox types are available:

- Extension - the auto-attendant will transfer a caller to the mailbox's associated extension. If the called party is busy or does not answer, the caller will be prompted to leave a message in the mailbox. The extension mailbox may be linked to other mailboxes for transfer only (dual mailboxes). This permits the caller to transfer to other mailboxes in the same department.
- Message-Only - the auto-attendant will not attempt a transfer but will immediately prompt the caller to leave a message in the mailbox.
- Transfer-Only - the auto-attendant will transfer a caller to the mailbox's associated extension, but will not take a message if the called party is busy or does not answer.
- Information-Only - the auto-attendant will only play the mailbox greeting; no transfer or prompt to leave a message will occur.

NuPoint Messenger Voice Mail

The NuPoint Messenger voice mail is a full-featured, PC-based voice mail system which supports a wide range of voice, fax, and data store-and-forward applications. The processor converts human speech to digital signals and stores them on a hard disc.

Using NuPoint Messenger voice messaging, you can send and receive recorded messages and faxes from any DTMF telephone anywhere in the world. Fax and voice messages are sent and received from your personal "mailbox". This gives you access to information remotely, and assures you of secure access to your documents. You determine when and where you want your fax messages to be delivered.

A key feature of the NuPoint Messenger system is its ability to answer your telephone when you are not available. Calls are forwarded automatically to your voice mailbox. The caller is given the choice of recording a message, leaving a fax, speaking to someone else, or requesting personal assistance. When someone has left a message for you, the NuPoint Messenger system can notify you with a message waiting light or a distinctive ringing pattern to signal that a new message has arrived. The system will also perform two types of outdial notification: Message Delivery and Paging.

- Message Delivery - Allows you to define a schedule so that if a message arrives in your mailbox, NuPoint Messenger will call you at a specific telephone number at a specific time so that you can retrieve the message.
- Paging - Allows you to define a schedule so that when a message arrives in your mailbox, NuPoint Messenger notifies your pager.

Other optional features are listed below:

- Call Agent - Adds call processing capabilities to your voice mail system. You can create automated attendant call processing applications, letting you control the time, destination and method of each call processing event. You have the option of arranging the presentation of what callers hear and where callers go within the system.
- Auto Wakeup - Allows mailbox users to schedule reminder calls to be directed to specific telephone numbers.

- Cut-Through Paging - Sends the actual call-back number rather than the mailbox number to the mailbox user's pager.
- FaxMemo - Allows the user to send, receive, answer, voice annotate, and distribute fax messages. It also provides automatic and/or scheduled delivery via facsimile. A FaxMemo card is required; software is supplied with the NuPoint Messenger system.
- Softkey Support - Allows users of SUPERSET 420, SUPERSET 430, SUPERSET 4025, SUPERSET 4125, and SUPERSET 4150 telephones to access voice mail features by using softkeys. Softkey support is available with MITEL Express Messenger and when NuPoint Messenger has a DNIC connection.

Feature Description

The features serve the following categories:

- System
- Telephone
- Attendant and Subattendant
- Key System Support
- Hotel /Motel
- Data
- Automated Call Distribution (ACD TELEMARKETER Application)
- Automated Attendant.

System features apply to the system or to devices such as extensions, datasets, consoles, trunks, and SUPERSET telephones. The system features are available to all extension users.

Telephone features apply to the SX-200 EL and SX-200 ML systems for rotary, DTMF, and SUPERSET telephones.

Attendant and Subattendant features apply to the SUPERCONSOLE 1000 Console or the SUPERSET 7000 Attendant Console. It also describes the Subattendant and Enhanced Subattendant features that are performed on a SUPERSET 4150, SUPERSET 430 or SUPERSET 4DN telephone .

Key system features are available to all telephone sets. With the merging of CDE Form 9 (Station/SUPERSET Telephones) and Form 45 (Key System Telephones) in LIGHTWARE 18, the telephone can have a mix of system features and key system features.

Hotel /Motel features apply to Attendant Consoles, Front Desk Terminals, SUPERSET display telephones, Industry-standard, SUPERSET 401 and SUPERSET 401+ telephones, and the SX-200 EL and SX-200 ML systems. Each of these terminal types can access a subset of the Hotel/Motel features.

Data features apply to the data functions that are supported by the SX-200 EL and SX-200 ML systems.

Automated Call Distribution (ACD TELEMARKETER) features apply to SUPERSET display telephones programmed with special displays and softkeys. The displays provide call status and progress messages; the softkeys give single-button selection of ACD features.

Automated Attendant features apply to the direction of incoming calls to a recorded announcement device (RAD). The RAD message instructs callers that by dialing over the message they can access a directory number on the system. Callers choosing not to dial during the message are routed to a default answering point, such as an Attendant, when the message is finished.

Feature Categories

The table below alphabetically lists the SX-200 EL/ML features, provides the software release that introduced that feature, and groups the feature into a category. Some features are available to all devices, while others are available to specific devices such as extensions, datasets, consoles, trunks, or SUPERSET telephones; certain features are available only with specific software releases. A brief description of each feature follows the table. A detailed description of each feature can be found in the Features section in the SX-200 EL/ML Technical Documentation.

Feature Categories								
Feature	Initial LIGHTWARE Release	System	Telephone	Attendant and Sub-Attendant	Hotel Motel	Data	ACD TELEMARKETER	Automated Attendant
Abbreviated Dial	Pre LW 15	•						
Access Codes-Global Find	Pre LW 15	•						
Account Codes	Pre LW 15	•						
Account Codes - Verified	Pre LW 15	•						
Account Codes - Verified (Special DISA)	Pre LW 15	•						
Add Held	Pre LW 15		•					
Analog Networking	Pre LW 15	•						
Attendant Abbreviated Dial Number Entry	Pre LW 15			•				
Attendant Access (Dial 0)	Pre LW 15			•				
Attendant Advisory Message Setup	Pre LW 15			•				
Attendant Alarm Readout	Pre LW 15			•				
Attendant Automatic Overflow	Pre LW 15			•				
Attendant Bell Off	Pre LW 15			•				
Attendant Busy Override	Pre LW 15			•				
Attendant Callback-Busy No Answer	Pre LW 15			•				
Attendant Call Forward Setup and Cancel	Pre LW 15			•				
Attendant Call Selection	Pre LW 15			•				
								Page 1 of 18

Feature Categories (continued)								
Feature	Initial LIGHTWARE Release	System	Telephone	Attendant and Sub-Attendant	Hotel Motel	Data	ACD TELEMAR-KETER	Automated Attendant
Attendant Call Splitting and Swapping	Pre LW 15			•				
Attendant Calls Forwarded On No Answer	Pre LW 15			•				
Attendant Conference	Pre LW 15			•				
Attendant Console Display Language	Pre LW 15			•				
Attendant Console Handset and Headset Receiver Volume Control	LW 17 Rel 4.0			•				
Attendant Console Last Call Retrieve	LW 17, page 122 Rel 4.0			•				
Attendant Console LCD Display	Pre LW 15			•				
Attendant Console LDN Keys	Pre LW 15			•				
Attendant Console Lockout	Pre LW 15			•				
Attendant Console Macro Keys	LW 17 Rel 4.0			•				
Attendant Console Set Paging- Directed, Group, or All Set	LW 15			•				
Attendant Date and Time Setup	Pre LW 15			•				
Attendant Default Call Positions	Pre LW 15			•				
Attendant Destination (DEST) Key	Pre LW 15			•				
Attendant Directed Call Pickup	LW 16			•				
Attendant Direct Trunk Select	Pre LW 15			•				
Attendant DISA Code Setup	Pre LW 15			•				

Feature Categories (continued)								
Feature	Initial LIGHTWARE Release	System	Telephone	Attendant and Sub-Attendant	Hotel Motel	Data	ACD TELEMARKETER	Automated Attendant
Attendant Do Not Disturb Setup, Cancel or Override	Pre LW 15			•				
Attendant Emergency Call (911) Detection	LW 17 , page 123 Rel 3.1			•				
Attendant Extension Busy-Out	Pre LW 15			•				
Attendant Flash Over Trunk	Pre LW 15			•				
Attendant Function Access	Pre LW 15			•				
Attendant Hold Positions	Pre LW 15			•				
Attendant Implicit New Call	Pre LW 15			•				
Attendant Individual Directory Number	Pre LW 15			•				
Attendant Interposition Calling and Transfer	Pre LW 15			•				
Attendant Lockout Alarm	Pre LW 15			•				
Attendant Message Waiting Setup and Cancel	Pre LW 15			•				
Attendant Multi-New Call Tone	LW 15			•				
Attendant New Call Ring	Pre LW 15			•				
Attendant Night/Day Switching	Pre LW 15			•				
Attendant Paging Access	Pre LW 15			•				
Attendant Paged Hold Access	Pre LW 15			•				
Attendant Serial Call	Pre LW 15			•				
Attendant Source Key	Pre LW 15			•				
Attendant Timed Recall	Pre LW 15			•				
Attendant Tone Signaling	Pre LW 15			•				
								Page 3 of 18

Feature Categories (continued)								
Feature	Initial LIGHTWARE Release	System	Telephone	Attendant and Sub-Attendant	Hotel Motel	Data	ACD TELEMAR-KETER	Automated Attendant
Attendant Training Jacks	Pre LW 15			•				
Attendant Transfer To Campon	Pre LW 15			•				
Attendant Transparent Multi-Console Operation	Pre LW 15			•				
Attendant Trunk Busy-Out	Pre LW 15			•				
Attendant Trunk Group Status Display	Pre LW 15			•				
Auto-Answer	Pre LW 15		•				•	
Auto-Hold	Pre LW 15		•					
Automated Attendant	Pre LW 15	•						•
Automated Attendant - Auto-Attendant Group	Pre LW 15							•
Automated Attendant - Default Destination	Pre LW 15							•
Automated Attendant - Front End Recording	Pre LW 15							•
Automated Attendant - Illegal Number Handling	Pre LW 15							•
Automated Attendant - Prefix Digits	Pre LW 15							•
Automated Attendant - RAD Operation	Pre LW 15							•
Automated Attendant - Resource Allocation	Pre LW 15							•
Automated Attendant - Vacant Number Routing	Pre LW 15							•
Automatic Call Distribution (ACD)	Pre LW 15						•	
ACD - Path	Pre LW 15						•	
ACD - Positions	Pre LW 15						•	
ACD - Displays	Pre LW 15						•	
ACD - Longest Idle Agent	Pre LW 15						•	

Feature Categories (continued)								
Feature	Initial LIGHTWARE Release	System	Telephone	Attendant and Sub-Attendant	Hotel Motel	Data	ACD TELEMARKETER	Automated Attendant
ACD - Mobility	Pre LW 15						•	
ACD - Predictive Overflow	Pre LW 15						•	
ACD - Printed Reports	Pre LW 15						•	
ACD- Real Time Event	LW 17 Rel 4.0						•	
ACD - Recorded Announcements	Pre LW 15						•	
ACD - Sets	Pre LW 15						•	
Automatic Number Identification (ANI) on Outgoing Trunks	LW 15	•						
ANI / Dialed Number Identification Service (DNIS) on Incoming Trunks	LW 15	•						
Automatic Route Selection (ARS)	Pre LW 15	•						
Background Music	Pre LW 15		•					
BRI Card Support	LW 18 Rel 2.0	•				•		
Broker's Call (Station Swap)	Pre LW 15	•						
Broker's Call With Transfer (Transfer With Privacy)	Pre LW 15	•						
Busy Lamp Field	Pre LW 15		•					
Calculator	Pre LW 15		•					
Call Forwarding	Pre LW 15	•						
Call Forwarding - Busy	Pre LW 15	•						
Call Forwarding - Busy/No Answer	Pre LW 15	•						
Call Forwarding - Display Prime as Forwarded	Pre LW 15	•						
Call Forwarding - No Answer	Pre LW 15	•						
Call Forwarding - External	Pre LW 15	•						

Feature Categories (continued)								
Feature	Initial LIGHTWARE Release	System	Telephone	Attendant and Sub-Attendant	Hotel Motel	Data	ACD TELEMAR-KETER	Automated Attendant
Call Forwarding - Always	Pre LW 15	•						
Call Forwarding - Forced Call Forward	LW 17, page 136 Rel 3.0	•						
Call Forwarding -Forward Calls	Pre LW 15	•						
Call Forwarding - I'm Here	Pre LW 15	•						
Call Forwarding - Internal / External Split	Pre LW 15	•						
Call Forwarding - Toggle Keys	LW 18 Rel 1.0	•						
Call Logging	LW 18 Rel 1.0		•	•				
Call Park from Single-line Sets	Pre LW 15	•						
Call Park from Multi-line Sets	LW 17 Rel 3.1		•					
Call Park System Orbit	LW 17 Rel 4.0		•	•				
Call Rerouting	Pre LW 15	•						
Callback	Pre LW 15	•						
Callback - Busy	Pre LW 15	•						
Callback - No Answer	Pre LW 15	•						
Campon	Pre LW 15	•						
Campon Priority Over Call Forward Busy	LW 17 Rel. 1.0		•					
Campon Warning Tone	Pre LW 15		•					
Centralized Attendant	LW 17 Rel 2.0	•	•					
Centralized Voicemail	LW 17 Rel 2.0	•						
CENTREX™ Compatibility (Double Flash Over Trunk)	Pre LW 15		•					
CENTREX Compatibility (Single Flash Over Trunk)	Pre LW 15		•					

Feature Categories (continued)								
Feature	Initial LIGHTWARE Release	System	Telephone	Attendant and Sub-Attendant	Hotel Motel	Data	ACD TELEMARKETER	Automated Attendant
CLASS (station side) for Analog Telephones	LW 18, page 140 Rel 2.0		•		•			
CLASS for Digital Sets	LW 16, page 141 Rel 1.0		•					
Class of Restriction (COR)	Pre LW 15	•						
Class of Service (COS)	Pre LW 15	•						
Clear All Features	Pre LW 15	•						
CO Line Group Key	Pre LW 15		•	•				
CO Line Key	Pre LW 15		•	•				
CO Line - Select Direct	Pre LW 15		•	•				
CO Line Type - Direct Access - Bypass Key System Toll Control	Pre LW 15		•	•				
Conference	Pre LW 15	•						
Conflict Dialing	Pre LW 15	•						
Consoleless Operation	Pre LW 15	•						
Contact Monitor	Pre LW 15	•						
Customer Data Entry	Pre LW 15	•						
Customer Data Entry - Default Data	Pre LW 15	•						
Customer Data Entry - Range Programming	Pre LW 15	•						
Customer Data Print	Pre LW 15	•						
Data: Abbreviated Dial for ADL Calls	Pre LW 15					•		
Data: Account Codes	Pre LW 15					•		
Data: Associated Data Line (ADL)	Pre LW 15					•		
Data: ADL Hotline	Pre LW 15					•		
Data: ADL Speed Call Originate	Pre LW 15					•		
Data: Associated Modem Line	Pre LW 15					•		
Data: Auto-Answer	Pre LW 15					•		

Feature Categories (continued)								
Feature	Initial LIGHTWARE Release	System	Telephone	Attendant and Sub-Attendant	Hotel Motel	Data	ACD TELEMAR-KETER	Automated Attendant
Data: Automatic Data Route Selection (ADRS)	Pre LW 15					•		
Data: Hunt Groups	Pre LW 15					•		
Data: Modem Pooling	Pre LW 15					•		
Data: Modem Pooling Queuing	Pre LW 15					•		
Data: Peripherals	Pre LW 15					•		
Data Security	Pre LW 15					•		
Data Station Message Detail Recording (Data SMDR)	Pre LW 15	•				•		
Data Station Queuing	Pre LW 15					•		
Data Transceiver (DTRX)	Pre LW 15					•		
Data: DTRX Call By Name	Pre LW 15					•		
Data: DTRX Call Originate/Disconnect	Pre LW 15					•		
Data: DTRX Help	Pre LW 15					•		
Data: DTRX Hotline	Pre LW 15					•		
Data: DTRX Messages	Pre LW 15					•		
Daylight Savings Time Adjustment	LW 17, page 142 Rel 3.1	•						
Device Interconnection Control	Pre LW 15	•						
Dial Tone Disable	Pre LW 15	•						
Dial Tone - Discriminating	Pre LW 15	•						
Dictation Trunks	Pre LW 15	•						
DID/Dial-In /Tie Intercepts	Pre LW 15	•						
Digit Translation	Pre LW 15	•						
Direct-In Lines (DIL)	Pre LW 15	•						
Direct Station Page/Busy Lamp Field	LW 17 Rel 4.0		•	•				

Feature Categories (continued)								
Feature	Initial LIGHTWARE Release	System	Telephone	Attendant and Sub-Attendant	Hotel Motel	Data	ACD TELEMAR-KETER	Automated Attendant
Direct Station Select (DSS) Key	Pre LW 15		•					
Direct Station Select / Busy Lamp Field (DSS/BLF) Call Pickup	LW 17 , page 148 Rel 4.0		•	•				
DSS/BLF Interface Unit	LW 17 Rel 3.1			•				
Direct to ARS	Pre LW 15	•						
Direct Trunk Select	Pre LW 15		•					
Disconnect Alarm	Pre LW 15		•					
Display Caller ID on Non-Prime Lines	LW 19 Rel 2.0		•					
Display Keys	Pre LW 15		•					
Do Not Disturb	Pre LW 15	•						
DTMF-To-Rotary Dial Conversion	Pre LW 15	•						
Emergency Call Handling	LW 17 Rel 4.0	•						
Emergency Calls (911) - Detection and Reporting to Attendant Consoles	LW 17 Rel 3.1			•				
Emergency Calls (911) Reporting and Detection to Display Sets	LW 18 Rel 1.0		•					
Emergency Calls (911) - Reporting to PSAP	LW 17 , page 152 Rel 4.0	•						
Expensive Route Warning	Pre LW 15		•					
FAX Tone Detection	LW 17 Rel 2.0							•
Feature Keys	Pre LW 15		•					
Flash - Calibrated	Pre LW 15		•					
Flash Control	Pre LW 15		•					
Flash Disable	Pre LW 15		•					
Flash For Dial 0 (Attendant)	Pre LW 15		•					
Flash For Waiting Call	Pre LW 15	•						

Feature Categories (continued)								
Feature	Initial LIGHTWARE Release	System	Telephone	Attendant and Sub-Attendant	Hotel Motel	Data	ACD TELEMAR-KETER	Automated Attendant
Flash Timing	Pre LW 15	•						
Forward Campon	Pre LW 15		•					
Group Listening	LW 17 Rel 2.0		•					
Handset Mute	LW 17 Rel 3.0		•					
Handset Receiver Volume Control	Pre LW 15		•					
Handsfree Announce	LW 15 Rel 1.0		•					
Handsfree Answerback to a Directed Page	LW 15, page 157 Rel 1.0		•					
Handsfree Operation	Pre LW 15		•					
Headset Mode Feature Key	LW 17, page 157 Rel 3.0		•					
Headset Mode - Automatic	LW 18 Rel 1.0							
Headset Operation	Pre LW 15		•					
Headset Operation (Amplified Headset)	LW 17, page 157 Rel 3.0		•					
Headset With In-line Switch Operation	LW 17 Rel 3.0		•					
Hold	Pre LW 15	•						
Hold Reminder	Pre LW 15		•					
Holiday Messages	Pre LW 15	•	•					
Hot Line	Pre LW 15	•						
Hotel / Motel (Lodging)	Pre LW 15				•			
Hotel / Motel - Attendant Console Guest Room Softkey	Pre LW 15				•			
Hotel / Motel -Attendant Message Register , page 159 Audit	Pre LW 15				•			
Hotel / Motel -Attendant Message Waiting Setup and Cancel	Pre LW 15				•			

Feature Categories (continued)								
Feature	Initial LIGHTWARE Release	System	Telephone	Attendant and Sub-Attendant	Hotel Motel	Data	ACD TELEMARKETER	Automated Attendant
Hotel / Motel -Audits	Pre LW 15				•			
Hotel / Motel -Audit Screen	Pre LW 15				•			
Hotel / Motel - Wakeups	Pre LW 15				•			
Hotel/Motel - Personal and Multiple Wakeups	LW 18 Rel 1.0				•			
Hotel / Motel -Call Blocking	Pre LW 15				•			
Hotel/Motel - Sub Attendant Call Blocking	LW 18, page 162 Rel 1.0				•			
Hotel / Motel -Call Restriction	Pre LW 15				•			
Hotel / Motel -Check Out	Pre LW 15				•			
Hotel/Motel - CLASS (station side) for Analog Telephones	LW 18, page 162 Rel 1.0				•			
Hotel / Motel -Do Not Disturb (DND)	Pre LW 15				•			
Hotel / Motel -Front Desk Features	Pre LW 15				•			
Hotel / Motel -Guest Names	Pre LW 15				•			
Hotel / Motel -Guest Room Message Retrieval	Pre LW 15				•			
Hotel / Motel -Guest Room SUPERSET Key Programming	Pre LW 15				•			
Hotel / Motel -Guest Room Update Screen	Pre LW 15				•			
Hotel / Motel -Guest Search Screen	Pre LW 15				•			
Hotel / Motel -House Statistics Screen	Pre LW 15				•			
Hotel / Motel -Maid in Room Status Display - SUPERSET Display Telephones	Pre LW 15				•			

Feature Categories (continued)								
Feature	Initial LIGHTWARE Release	System	Telephone	Attendant and Sub-Attendant	Hotel Motel	Data	ACD TELEMAR-KETER	Automated Attendant
Hotel / Motel -Message Lamp Test	Pre LW 15				•			
Hotel / Motel -Message Register	Pre LW 15				•			
Hotel / Motel - Multi-user	Pre LW 15				•			
Hotel / Motel - Passwords	Pre LW 15				•			
Hotel / Motel - Property Management System (PMS)	Pre LW 15				•			
Hotel / Motel - Room Condition	Pre LW 15				•			
Hotel / Motel - Room Occupancy	Pre LW 15				•			
Hotel / Motel -Room Search Screen	Pre LW 15				•			
Hotel / Motel - Room Status Display	Pre LW 15				•			
Hotel / Motel - Room Types and Room Codes	Pre LW 15				•			
Hotel / Motel - Single Line Reports	Pre LW 15				•			
Hotel / Motel - Suite Services	LW 18 Rel 2.0				•			
Hunt Groups	Pre LW 15	•						
Illegal Access Intercept	Pre LW 15	•						
Inhibit Trunk Ring-Me-Back During Dialing	Pre LW 15	•						
Intercept to Recorded Announcement	Pre LW 15	•						
Internal Number Block	LW 18, page 169 Rel 2.0	•			•			
Inward Restriction (DID)	Pre LW 15	•						
Language Change	Pre LW 15		•					
Last Number Redial	Pre LW 15	•						

Feature Categories (continued)								
Feature	Initial LIGHTWARE Release	System	Telephone	Attendant and Sub-Attendant	Hotel Motel	Data	ACD TELEMARKETER	Automated Attendant
Last Party Receives Dial Tone	Pre LW 15		•					
Line Lockout	Pre LW 15	•						
Line Preference	Pre LW 15		•					
Line Privacy	Pre LW 15	•						
Line Selection	Pre LW 15		•					
Line Types and Appearances	Pre LW 15	•						
Lockout Alarm	Pre LW 15	•						
Logical Lines	Pre LW 15		•					
Maintenance	Pre LW 15	•						
Manual Line (Dial 0 Hotline)	Pre LW 15	•						
Messaging - Advisory	Pre LW 15		•					
Messaging - Call Me Back	Pre LW 15	•						
Meter Pulse Collection	Pre LW 15	•						
MILINK Data Module	LW 15		•					
MITEL Application Interface (MAI)	Pre LW 15	•						
MITEL Network Gateway	LW 15	•						
Moving Stations and SUPERSET Telephones	Pre LW 15		•					
Multi-Attendant Positions	Pre LW 15			•				
Music - on - Hold (MOH)	Pre LW 15	•						
Music - on - Hold (MOH) (multiple)	LW 17 Rel 3.0	•						
Music from an ONS Source	LW 19 Rel 3.0	•						
Names	Pre LW 15		•					
Never a Consultee	Pre LW 15	•						
Never a Forwardee	Pre LW 15	•						
New Call Ring	Pre LW 15		•					
NI3 Calling Name Delivery	LW 18 Rel 1.0	•						

Feature Categories (continued)								
Feature	Initial LIGHTWARE Release	System	Telephone	Attendant and Sub-Attendant	Hotel Motel	Data	ACD TELEMAR-KETER	Automated Attendant
Night Bells	Pre LW 15	•						
Night/Day Switching	Pre LW 15		•					
Night Services	Pre LW 15	•						
Night Services Flexibility	Pre LW 15	•						
Node Identification	Pre LW 15	•						
Non-Busy Extension	Pre LW 15	•						
Numbering Plan Flexibility (Conflict Dialing)	Pre LW 15	•						
Off-Hook Alarm to Display Sets	LW 18 Rel 1.0		•					
Off-Hook Voice Announce	LW 17 Rel 1.0		•					
Off-Premises Extension	Pre LW 15	•						
ONS Positive Disconnect	LW 18 Rel 2.0				•			•
ONS Ring Groups	LW 19 Rel 2.0	•						
Originate Only Extensions	Pre LW 15	•						
Overlap Outpulsing	Pre LW 15	•						
Override (Intrude)	Pre LW 15	•						
Override Security	Pre LW 15	•						
Paging - PA	Pre LW 15	•						
Paging - Telephones	Pre LW 15		•					
Paging - PA and Telephones	LW 19 Rel 2.0	•	•					
Paging - All Set Page	LW 17 Rel 1.0		•					
Parallel Connection of Industry-standard Telephones	Pre LW 15	•						
Personal Speed Call	Pre LW 15		•					
Pickup - Local and Directed	Pre LW 15	•						
PRI Card Support	LW 17 Rel 4.0	•						
Printer / Terminal Support	Pre LW 15	•						

Feature Categories (continued)								
Feature	Initial LIGHTWARE Release	System	Telephone	Attendant and Sub-Attendant	Hotel Motel	Data	ACD TELEMARKETER	Automated Attendant
Priority Dial 0	Pre LW 15	•						
Privacy Enable / Privacy Release	Pre LW 15		•					
Programmable Key Module (PKM)	PKM LW 15 PKM 48 LW17 R3 PKM 12 LW18 R2		•	•				
Q.SIG	LW 18 Rel 1.0	•						
RAD Support	Pre LW 15	•					•	•
Recall	Pre LW 15	•						
Receive Only Extensions	Pre LW 15	•						
Record a Call	LW 18 Rel 1.0	•						
Remote LAN Access	LW 18 Rel 1.0	•						
Reminder	Pre LW 15	•			•			
Reminders - Multiple	LW 18 Rel 1.0	•			•			
Resale Package	, page 185, Pre LW 15	•						
Ringer Control	Pre LW 15		•					
Ringing - Discriminating	Pre LW 15	•						
Ringing - Plan	Pre LW 15	•						
Ringing Time-Out (Final Ringback)	Pre LW 15	•						
Satellite PBX	Pre LW 15	•						
Secretarial Line	Pre LW 15		•					
Speak@Ease Support	LW 18 Rel 1.0		•					
Speaker Volume Control	Pre LW 15		•					
Speed Call Key	Pre LW 15		•					
Split	Pre LW 15		•					
Station Message Detail Recording (SMDR)	Pre LW 15	•						

Feature Categories (continued)								
Feature	Initial LIGHTWARE Release	System	Telephone	Attendant and Sub-Attendant	Hotel Motel	Data	ACD TELEMAR-KETER	Automated Attendant
Subattendant - Basic Function	Pre LW 15			•				
Subattendant - Enhanced Functions	Pre LW 15			•				
Subattendant - Abbreviated Dial Programming	Pre LW 15			•				
Subattendant - Advisory Message Setup	Pre LW 15			•				
Subattendant - Automatic Call Wakeup	LW 17 Rel 4.0			•	•			
Subattendant - Call Blocking	LW 18 Rel 1.0			•	•			
Subattendant - Call Forward Setup and Cancel	Pre LW 15			•				
Subattendant - Calls Waiting Indication	Pre LW 15			•				
Subattendant - Date and Time Setup	Pre LW 15			•				
Subattendant - Hold Positions	Pre LW 15			•				
Subattendant - LDN Keys	Pre LW 15			•				
Subattendant - Paged Hold Access	Pre LW 15			•				
Subattendant - Recall	Pre LW 15			•				
Subattendant - Station DND Setup	Pre LW 15			•				
SUPERSET 3DN and SUPERSET 4DN Auto-Answer For Directed Page Calls	Pre LW 15		•					
SUPERSET 3DN and SUPERSET 4DN Option	LW 17 Rel 3.1		•					
SUPERSET LCD Display	Pre LW 15		•					
Swap (Trade Calls)	Pre LW 15		•					
Swap Campon	Pre LW 15	•						

Feature Categories (continued)								
Feature	Initial LIGHTWARE Release	System	Telephone	Attendant and Sub-Attendant	Hotel Motel	Data	ACD TELEMARKETER	Automated Attendant
System Fail Transfer (SFT)	Pre LW 15	•						
System Identifier	Pre LW 15	•						
System ID Module	Pre LW 15	•						
Tandem Operation	Pre LW 15	•						
TAPI Support Over DNIC	LW 17 Rel 4.0	•	•					
Tenanting	Pre LW 15	•						
Toll Control	Pre LW 15	•						
Tone Demonstration	Pre LW 15	•						
Tone Plans	Pre LW 15	•						
Traffic Measurement	Pre LW 15	•						
Transfer	Pre LW 15	•						
Transfer Dial Tone	Pre LW 15	•						
Transfer Security (Recall)	Pre LW 15	•						
Trunk Answer From Any Station (TAFAS)	Pre LW 15	•						
Trunk Circuit Descriptor Options	Pre LW 15	•						
Trunk Dial Tone Detection	Pre LW 15	•						
Trunk Groups	Pre LW 15	•						
Trunk Operation - Direct Inward Dial (DID)	Pre LW 15	•						
Trunk Operation - Direct Inward System Access (DISA)	Pre LW 15	•						
Trunk Operation - Non-Dial-in CO	Pre LW 15	•						
Trunk Operation - Tie	Pre LW 15	•						
Trunk Recall	Pre LW 15	•						
Trunk Support - CO (LS/GS)	Pre LW 15	•						
Trunk Support - Direct Inward Dial (DID)	Pre LW 15	•						
Trunk Support - E&M	Pre LW 15	•						
Trunk Support - T1	Pre LW 15	•						

Feature Categories (continued)								
Feature	Initial LIGHTWARE Release	System	Telephone	Attendant and Sub-Attendant	Hotel Motel	Data	ACD TELEMAR-KETER	Automated Attendant
Uniform Call Distribution	Pre LW 15	•						
Vacant Number Intercept	Pre LW 15	•						
Voice Mail Support	Pre LW 15	•						
Voice Mail Support - Centralized	LW 17 Rel 1.0	•						
Voice Mail Support - softkeys	LW 17 Rel 3.1	•						
Voice Mail Support - Single Button Transfer	LW 19 Rel 2.0	•						
Whisper Announce	LW 17 Rel 1.0		•					

Abbreviated Dial

The Abbreviated Dial feature allows trunks and extensions to be accessed by dialing a two-to eight-digit number that the system translates into the actual, longer number. The actual number can contain up to 26 digits.

Abbreviated Dial can also give system-wide access to a defined set of long distance numbers, while denying general access to long-distance dialing.

Abbreviated Dial numbers can also be used as dial-in trunk prefixes, as routing points for ACD interflow and automated attendant, and as call-forwarding points.

The attendant or CDE programmer can program or display system Abbreviated Dial numbers. These numbers can be marked as confidential to prevent them from appearing on display telephones or in SMDR reports.

Access Codes - Global Find

This feature allows authorized users to display all Access Codes in the system. The system reports the type of device associated with the Access Code and its location (bay/slot/circuit). The user can also query the system about a particular Access Code.

Account Codes

Account Codes are typically used to charge the cost of outgoing trunk calls to departmental cost centers or project accounts. The Account Code can be optional or required, and appears on all Station Message Detail Recording (SMDR) records. An Account Code can apply to both incoming and outgoing trunk calls.

Enabling Forced Account Codes for industry-standard telephones which also have Direct To ARS enabled, forces users to dial an account code before they can originate a call.

Users of SUPERSET display telephones, can also enter account codes during a 2-party call, when the other party is a trunk of any type. The account code softkey is present, providing that a consultation hold is not in progress and the set has completed dialing.

Account Codes can range from 1 to 12 digits.

For Verified Account Codes, see Account Codes - Verified.

Account Codes can also apply to data calls. See Data: Account Codes.

Account Codes - Verified

Account Codes - Verified helps to ensure accuracy for accounting purposes, and helps prevent fraudulent use of Direct Inward System Access (DISA) lines and outgoing trunks. Verified Account Codes control access to trunks and external (DISA) access to the system by checking the dialed account code against a list of preprogrammed codes.

The caller's COS and COR can be changed (traveling class of service) when a valid Account Code is entered. This can give the caller access to different features and external call privileges. If the caller's COS is changed and the Direct to ARS feature is enabled in the COS, the Direct to ARS feature operates immediately.

Each Verified Account Code has an active/inactive status. This allows accounts to be denied access when problems are encountered such as nonpayment of billings. See also Account Codes - Verified (Special DISA), Resale Package, Trunk Operation (DISA) and Analog Networking.

Account Codes - Verified (Special DISA)

Verified Account Codes can be used to replace the DISA Access Code. A caller who accesses a Special DISA trunk must dial an Account Code rather than the DISA Code. By using a Verified Account Code, each DISA trunk can have access to its own COS options through the COS and COR associated with the Account Code. SMDR records each of these calls.

Add Held

Add Held allows a user engaged in an active call on a SUPERSET display telephone to add a call that is on hold on another line, to the current line.

Analog Networking

Analog Networking allows an SX-200 EL and SX-200 ML systems to send and receive caller information over a private network. The other nodes in the network can be any combination of Mitel Networks SX-200 PBXs and SX-2000 INTEGRATED COMMUNICATIONS systems. Analog Networking uses the ARS Modified Digit feature to insert feature access codes and other codes (called information elements) into the outgoing digit string. The information elements consist of special codes for inserting the caller's Extension Number, Account Code, and Node Identification.

The system with Analog Networking can function as an end node, an intermediate node, or a hub. As an end node, network elements are transmitted into the network via DTMF digits. As an intermediate node, all information elements received by the intermediate node are passed on to the next node. As a hub, the system receives information elements to provide Calling Party Identification.

The information elements are

- Caller's Extension Number

This element is displayed on consoles and SUPERSET display telephones. When the call is answered, the Caller's Extension Number replaces the trunk number or trunk name. The Caller's Extension Number also replaces the trunk number in SMDR records.

- Caller's Dialed Account Code

The existing account code access code identifies the beginning of a Caller's Dialed Account Code. The Account Code is written into the SMDR record associated with the call. Verified Account Codes can be used to implement Travelling Class Marks by providing a COS and COR with the Account Code. The account code's COS and COR replace the COS and COR associated with the trunk being used at the destination node. The destination node processes the call using the COS and COR associated with the Caller's Verified Account Code that was passed on the trunk.

- PBX Node ID

This information element is associated only with the originating node and must be imbedded with another information element because it has no access code of its own (usually it is the first digit of the extension number).

Attendant Abbreviated Dial Number Entry

This feature allows the Attendant to program System Abbreviated Dial numbers from the Attendant Console. Selected attendants have the option of making Abbreviated Dial numbers confidential. This restricts the viewing and changing of the number to only those attendants permitted to do so. See Abbreviated Dial.

Attendant Access (Dial 0)

A feature access code (usually 0) is provided for reaching the attendant. The destination can change based on night/day service. The destination can be a device type other than a console or LDN. There is also a second class of dial 0, which is described in Priority Dial 0.

The Attendant can be reached by dialing

- Attendant Access Code (usually 0)
- Console directory number
- Attendant Access code which is routed to an LDN key.

Attendant Advisory Message Setup

There are eight default messages and seven programmable messages for use on SUPERSET display telephone LCD displays. The Attendant can read a set's currently displayed message, or read through the available messages and choose one for display on the set.

Attendant Alarm Readout

The Attendant Console can display the alarm logs active in the system. Using the softkeys, the Attendant can read the alarm messages one by one. The message indicates the fault and its location.

Attendant Automatic Overflow

Attendant Automatic Overflow provides a recorded announcement to incoming calls that are not answered by the attendant within a predefined time. This feature operates primarily during peak periods of incoming traffic.

Attendant Bell Off

The Attendant Bell Off feature allows the Attendant to mute the console ringer. Incoming calls are indicated by a flashing Answer Key LED and LDN softkeys displayed on the console. When the console ringer is disabled, "BELL OFF" appears on the second line of the console LCD display.

Attendant Busy Override

The Attendant Busy Override feature allows an Attendant who encounters a busy connection to override the connection and enter the call.

Attendant Callback - Busy/No Answer

The attendant can set up a callback if the called destination is busy or does not answer. The attendant can also cancel all callbacks in the system.

Attendant Call Forward Setup and Cancel

This feature allows the Attendant to set up, review and cancel call forwarding for any extension. The extension for which the Attendant sets up forwarding need not have any of the Call Forwarding features in its COS. The Attendant may also set up Call Forwarding from the extension to the Attendant. The Attendant can also cancel Call Forwarding for all extensions at the same time.

Attendant Call Selection

The Attendant Call Selection feature allows the Attendant to answer calls either in sequence or by call type. The Attendant Console has up to ten call selection positions that appear as softkeys when the console is receiving an incoming call. The system sets up some positions by default for certain call types. Other positions are user defined LDN keys. Calls arriving at the console are queued on a first come first served basis and the answer LED flashes. The LCD display also indicates the number of calls waiting. Pressing the Answer key answers calls in the order that they arrived at the console regardless of call type. Using a selection position softkey answers calls by call type regardless of the time they arrived at the console.

Attendant Call Splitting and Swapping

While setting up a call between two parties, the Attendant may be required to speak to both parties at the same time, or to speak privately with either party. The Attendant can do this by using the CONF, SOURCE, and DEST softkeys.

Attendant Calls Forwarded On No Answer

Calls directed to the console LDN that are not answered within a predetermined time-out period are rerouted to a NIGHT1 destination. The NIGHT1 answer point is programmable through CDE, and can vary depending upon the type of trunk or device that originated the call.

Attendant Conference

The Attendant Conference feature allows the Attendant to enter into a conference with the source and destination parties of a call. The Attendant may also initiate a three-party conference call. When the Attendant is in a conference, a periodic warning beep is given to all internal parties if the Attendant Conference Beeps system option is enabled.

Attendant Console Display Language

This feature allows the Attendant to change the display of Attendant Console softkeys from English to French, or from French to English.

Attendant Console Handset and Headset Receiver Volume Control

The attendant on a SUPERCONSOLE 1000 (Part Numbers 9189-000-300 and 9189-000-301) can use the volume keys to adjust the console ringer and the volume of the handset and the headset receiver.

Attendant Console Last Call Retrieve

Allows the attendant to retrieve a ringing call after accidentally releasing a call to the wrong extension number.

Attendant Console LCD Display

The time of day is continually exhibited on the status line of the Attendant Console LCD display. When the console is idle, the date (month, day, year) is also displayed. The Console attendant can change the date or time. The Attendant Console may have calls from outside trunks and extensions queued waiting to be answered. The total number of calls in the queue is displayed in the Attendant Console queue (Calls Waiting) area of the display (top right corner). The Attendant can put a party on softhold or hardhold when that party also has a call (one party or Conference) on softhold. This is called stack hold.

When the Attendant Console establishes or answers a call, the display provides information about the call. The available items of call information are

- Extension Number and Set Name
- Tenant Name
- Trunk Name
- Trunk Group Name
- Trunk Number
- COS and Class Of Restriction (COR)
- COS Name.

The system programmer can assign names to Sets, Classes Of Service, Tenants, Trunks and Trunk Groups. See Names.

Attendant Console LDN Keys

Each console has nine programmable listed directory number (LDN) positions. Each LDN position can be programmed as the answer point for a particular type of call. Each LDN key can be given a descriptive label, allowing the attendant to answer the call with an appropriate response.

LDNs can appear at more than one console in a system to allow calls to be presented to specified consoles simultaneously. The Attendant Console can answer calls from a LDN by either using the Answer key or by selecting the LDN key directly. See Attendant Call Selection.

Attendant Console Lockout

The Attendant can enter an access code to restrict the capabilities of the Attendant Console. This can prevent system tampering via the console when the console is unattended. When the console is locked out, the following restrictions take effect:

- No outgoing trunk calls can be made
- There is no Attendant function access.

The Attendant Console can still be used to initiate internal calls, and to answer incoming trunk calls.

Attendant Console Macro Keys

The attendant on the SUPERCONSOLE 1000 (Part Numbers 9189-000-300 and 9189-000-301) can program macro keys using the two blank keys between the Trunk Group key and the Set Page Key. The Trunk Group key and the Set Page Key can also be reprogrammed to be a macro key (a macro is a series of keystrokes that you assign to a single key).

Attendant Console Set Paging - Directed, Group, or All Set

The attendant can press the Set Page hardkey on the console to make a directed page or group page. The all set page is activated with a feature access code and then the softkey prompts or with pressing the Page hardkey.

Attendant Date and Time Setup

The time of day is continually displayed on the right-hand portion of the status line of the Attendant Console LCD display. When the console is idle, the date (month, day, year) is also displayed. The displayed time is used by Message Waiting, Traffic Measurement, SMDR operations and SUPERSET display telephones. The time may be displayed in 12- or 24-hour format. The console can change the date and/or time.

Attendant Default Call Positions

Three incoming call indicators identify calls to the console directory number. These three default positions are

- F0 (NIGHT BELL): Calls ringing any night bell in the console's tenant group
- F1 (RECALL): Recalls of calls handled by the console, or for multiple console operation, by any console in the system
- F2 (INTERNAL): Calls directed to the console's internal directory number.

Attendant Destination (DEST) Key

This feature allows the attendant to press a softkey (DEST) to speak to the destination party of a call, to SWAP between the destination and source parties or to SPLIT a conference call. The destination party's extension number, COS, and COR are displayed on the second line of the console's LCD display and the source party is put on consultation hold. See Attendant Call Splitting and Swapping.

Attendant Directed Call Pickup

The attendant can perform a directed call pickup from the console. This will permit calls to be retrieved before the recall timer expires or if calls have been transferred to the wrong extension.

Attendant Direct Trunk Select

The console may access (seize) a trunk directly to place a call or to test the trunk.

Attendant DISA Code Setup

This option allows the Attendant to change the Direct Inward System Access (DISA) security code that a DISA caller must dial to access the system.

Attendant Do Not Disturb (DND) Setup, Cancel or Override

The Attendant may set up or cancel Do Not Disturb (DND) for an extension. When calling an extension with DND enabled, the Attendant may override the Do Not Disturb. See Do Not Disturb.

Attendant Emergency Call (911) Detection

See Emergency Call (911) - Detection and Reporting..

Attendant Extension Busy-Out

This feature allows the Attendant to busy out any extension, and to remove the busy-out condition. A busied-out extension is removed from service and cannot originate or receive any calls. If the attendant dials the number of a busied-out extension, the console displays the extension number and "BUSY OUT" in the destination display, and the attendant receives reorder tone.

Attendant Flash Over Trunk

The attendant can flash on any type of trunk by pressing the FLASH softkey. A flash is sent out on the trunk, and dialing is restarted on the trunk.

Attendant Function Access

By pressing the console FUNCTION key and the ATT FUNCTION softkey, the Attendant can access Attendant features including

- Abbreviated Dialing
- Alarm (read alarms)
- Application (To access CDE or maintenance)
- Bell On/Off (if enabled)
- Busy Out
- Call Forward
- Cancel All Callbacks
- Cancel All Call Forwarding
- DAY/NIGHT1/NIGHT2 Switching
- Do Not Disturb Setup and Cancel

- Flexible Night Service
- Forced Trunk Release
- Francais (French language prompts and messages on console)
- Guest Room functions (if enabled)
- Message Waiting Setup and Cancel
- Send Message
- Set Date
- Set Time
- Set Up Message
- Stations
- System Identifier
- Trunk Status/Access/Busy Out.

For more information about Attendant functions, refer to the individual feature descriptions in this guide.

Attendant Hold Positions

The Attendant can place an extension or trunk on hold in one of eight HOLD positions. There are four hold keys. HOLD1, HOLD2, and HOLD3 are for hold positions one through three. HOLD4 is for hold positions four through eight. A call hold recall time of 10 to 240 seconds can be programmed. The default is 30 seconds.

If the Attendant is visually impaired and unable to see the HOLD key LED, the Attendant Hold Position Security feature can be enabled. This allows for an error beep to sound if the Attendant attempts to put a call on hold by pressing a HOLD key that already has a party on hold.

Attendant Implicit New Call

When the Attendant presses a key on the console dial pad, by default a new call is initiated. When the first key is pressed, an existing party is automatically placed on hold. At the completion of dialing, the Attendant can transfer the call to the dialed destination by releasing from the call. This feature is temporarily disabled by pressing the TONES ON softkey. See Attendant Tone Signaling.

Attendant Individual Directory Number

Each Attendant Console has a unique directory number identifying that console. The directory number is in addition to the general attendant access number (usually 0) user dial to call the attendant or any LDN keys programmed at that console. A calling party has the choice of either dialing the general attendant access number, or dialing the directory number that is dedicated to a particular attendant position (useful when there is more than one Attendant position).

Attendant Interposition Calling and Transfer

In a multiple console environment, an Attendant can call or transfer a call to any other Attendant using the individual Attendant Directory Number. The call is transferred in the same manner as a call to an extension.

Attendant Lockout Alarm

The system locks out any set that remains off-hook and not connected to another set or trunk for more than 45 seconds. The lockout alarm feature:

- Generates an audible alarm through the console
- Activates the alarm relays
- Displays the location of the locked out device.

When a set is locked out, if lockout alarm is enabled, all consoles warble with a long-short-long cadence. This cadence overrides other cadences that might be active. The attendant can display the time and date the lockout alarm occurred, the extension number of the device, and a message stating that the device has been off-hook too long.

Attendant Message Waiting Setup and Cancel

This feature allows the Attendant to inform extension users that there is a message waiting. The message waiting indication may take the form of

- A message on the display of a SUPERSET display telephone.
- A continuously flashing lamp on the extension (if equipped).
- A distinctive ringing pattern repeated every 20 minutes. The pattern is three 350 ms bursts of ringing.

When the user returns and calls the Attendant, the "MSW" indicator appears on the console display to indicate that there is a message waiting for that extension. As an option, the system can be programmed to print a message on a system printer indicating each instance of a new message waiting. See Hotel / Motel Attendant Message Waiting Setup And Cancel.

When Transparent Multi-Console Operation is used, a Console may review or cancel a Message Waiting indication for any station; without this feature, only the Console that set the Message Waiting for a specific station can review or cancel it. A message may also be setup and canceled from the Front Desk.

Attendant Multi-New Call Tone

If an Attendant is actively engaged with an incoming call, the first call placed in the Attendant Call Waiting queue signals the attendant with a single burst of tone. As long as there are one or more calls waiting in the queue, the attendant will continue to hear the single burst of tone at the programmed time interval. The presence of any calls waiting is also shown by the call waiting indication on the top line of the display.

This feature is disabled if the attendant bell is turned off from the console. Also see Attendant Bell Off.

Attendant New Call Ring

If an Attendant is active on a call, the first call placed in the Attendant call waiting queue signals the Attendant with a single burst of ringing. Subsequent calls do not alert the Attendant when they are added to the queue. Their presence is shown by the call waiting indication on the top line of the display. See Attendant Console LCD Display.

Attendant Night/Day Switching

The Attendant can select NIGHT1, NIGHT2, or DAY service using softkeys. Also see Night Services.

Attendant Paging Access

The Attendant may access a paging zone or zones using the PAGE key on the Attendant Console. Pressing the PAGE key connects the console handset directly to the zones of the paging equipment programmed for default access for the console. This overrides any extension announcement in progress. The Attendant can alternatively access the paging circuit by dialing the associated access code followed by a digit (0 - 9) for the zone required (0 accesses all zones).

Attendant Paged Hold Access

The Attendant can put a party on hold and page for someone to pick up the call from the attendant hold position. When paging the called party, the Attendant announces the access code (for feature access code 16) plus the number of the call hold slot position that must be dialed to pick up the call.

Attendant Serial Call

The Attendant Serial Call feature allows an incoming trunk call to be set as a serial call before being transferred by the Attendant. After the call is finished, the Serial Call recalls the Attendant. This allows a caller to speak to several individuals in the system without the need for transfers by the called extensions.

Attendant Source Key

Pressing the SOURCE softkey allows the Attendant to speak with the source party of a call, to swap between the source and destination parties or to split up a conference call. The source party's extension number, COS, and COR are displayed on the first line of the Console's LCD display and the destination party is put on Consultation Hold. A party on Consultation Hold at the Console does not hear music.

Attendant Timed Recall

This feature automatically alerts the Attendant when a call extended through the Console or a call on hold at the Console has not been answered within a programmed time-out period.

Attendant Tone Signaling

The Attendant Console usually does not transmit DTMF tones. Applications such as Voice Mail, however, may require the Attendant to transmit tones. The Attendant Tone Signaling feature allows the Console to transmit DTMF tones during a call.

Attendant Training Jacks

Training jacks are provided on the Attendant Console for use by a supervisor or trainer who is training a new attendant. Each Console is equipped with two Attendant jacks. Either jack may be used by the Attendant, while the other provides a monitoring, supervisor, or training function.

Attendant Transfer To Campon

This feature allows the Attendant to connect calls to a busy extension, hunt group or trunk group for automatic completion when the called busy party becomes free. The Attendant cannot camp on but can transfer calls into Campon. See Campon. For details of recall from Campon, see Recall.

Attendant Transparent Multi-Console Operation

The Attendant Transparent Multi-Console Operation feature allows some features to apply to a group of consoles within a tenant. For example, when Transparent Multi-Console is used, a console may review or cancel a Message Waiting indication for any station. Without this feature, only the console that set the Message Waiting for a specific station, can review or cancel it. Recalls to the RECALL softkey for any console in the group can be answered by any console in the group.

When a SUPERSET display telephone user presses the CALL softkey to call the console in response to a message received, if the message was left by a console with the Transparent Multi-Console Operation feature enabled, the call is turned into a normal Dial 0 call and routes to the Dial 0 point of the SUPERSET telephone.

Attendant Trunk Busy-Out

The Attendant may busy-out a trunk to prevent access to the trunk, and may remove the busy condition as required. If the Trunk Busy-out Enable option is not selected, the Attendant may still access individual trunks, but is unable to force them into a busy condition.

Attendant Trunk Group Status Display

This feature allows the Attendant to display the status of trunk groups in the system. If this feature is activated while the Console is idle, the display is refreshed approximately every 5 seconds to allow a constant up-to-date monitoring of the trunk groups.

Auto - Answer

When the Auto-Answer feature is active, incoming calls give a burst of ringing and the set answers the call in handsfree mode. See Handsfree Operation. When the caller hangs up, a short burst of tone is heard over the SUPERSET telephone's speaker and the set goes idle. Call origination is not affected. Auto-Answer is available to all SUPERSET telephones (excluding SUPERSET 401, SUPERSET 4001, and 4090 telephones) when the telephone is in headset mode.

Auto - Hold

A SUPERSET telephone user automatically puts a call on hold when a Line Select key on the set is pressed. When this is not desirable, a COS option can be programmed which allows a call to be placed on hold only by pressing the Hold key.

Automated Attendant

The Automated Attendant feature directs incoming calls to a recorded announcement device (RAD). The RAD message instructs callers to dial over the message in order to access a directory number on the system. Callers choosing not to dial during the message are routed to a default answering point, such as an Attendant, when the message is finished. Incoming FAX calls can be detected and routed directly to a FAX destination. FAX tone detection is a separate feature that relies on Automated Attendant.

The Automated Attendant feature is a purchasable option.

Automated Attendant - Auto-Attendant Group

The Automated Attendant feature introduces an additional hunt group type called an Auto-Attendant group. This group is similar to the recording groups used in the ACD TELEMARKETER application but will not accept caller's input (DTMF). The Automated Attendant Feature is accessed by either rerouting or dialing into an Auto-Attendant group. This group can only contain station ports, and has the main features of any hunt group such as

- Hunt Group Number
- Access Code
- Circular or Terminal Hunting.

Auto-Attendant groups also have several options programmable through customer data entry (CDE) including

- Name
- Message Length
- Default Destination
- Prefix Digits
- Dialing Enabled
- Wait For Resources Time
- FAX destination (used with System Option 99, FAX Tone Detection).

Automated Attendant - Default Destination

When a recording ends, callers who have not dialed at least one digit during the recording are routed to the default destination

- Console
- LDN
- Night Bell
- Station
- SUPERSET telephone
- Logical line
- ACD path
- Hunt Group
- ACD positions (agent, supervisor and senior supervisor)
- System Abbreviated Dial.

Automated Attendant - Front End Recording

Front End Recordings present a message to the caller as soon as the call enters the system. For each recording group, dialing can be disabled during the recording. This provides a simple front-end recording without assigning a DTMF receiver. Digits dialed by the caller are ignored, and the prefix digits have no affect. Calls are routed to the default destination as usual.

Automated Attendant - Illegal Number Handling

If the dialed number is illegal, the system checks for illegal number routing. If the tenant group of the first member of the automated attendant group has illegal number routing programmed, the system redirects the caller to the routing point, which could be another group. If there is no illegal number routing programmed the caller is given reorder tone. Examples of illegal number conditions include

- Device interconnection
- Tenant interconnection
- Not valid for caller type
- Feature restricted.

Using the tenant of the first member of the auto attendant group ensures that the routing is based on the group called, ensuring that illegal number routing can be set up for each group.

Automated Attendant - Prefix Digits

Each automated attendant group can be programmed in CDE with a string of prefix digits. The prefix can contain from 0 to 4 digits, and is inserted in front of the digits dialed by the caller. This allows the caller to dial a single digit and be routed to devices that have normal multi-digit extension numbers. The prefix is only inserted if the caller dials at least one digit. The prefix can be used to

- Provide single digit menus
- Reduce digit dialing
- Restrict dialing to numbers that start with the prefix
- Provide entry into other features that require digits (such as ARS and feature access codes).

Automated Attendant - RAD Operation

RAD operation is similar to the RADs in the ACD TELEMARKETER application. The Automated Attendant feature uses the Auto-Attendant group as an enhanced recording group so the basic recording group features apply.

Automated Attendant - Resource Allocation

Each call entering the Automated Attendant feature uses two primary resources: a RAD and a DTMF Receiver. Usage differs between the two resources as follows. In the case of RADs, every time a RAD becomes free an unlimited amount of that resource becomes available because of the unlimited number of listen-only conferences that can be serviced by that one RAD. When a receiver becomes free, however, only one piece of that resource becomes available because only one caller can use the receiver at a time. Receiver availability therefore becomes the primary resource limitation for the Automated Attendant feature.

Automated Attendant - Vacant Number Routing

Handling of callers dialing a vacant number, such as an unassigned access code, is similar to the illegal number handling described above. In the case of a vacant number, vacant number routing is checked instead of illegal number routing.

Automatic Call Distribution (ACD)

Automatic Call Distribution (ACD) is a purchasable option that distributes calls evenly among trained operators (agents).

The ACD TELEMARKETER is an advanced Automatic Call Distribution (ACD) system that is fully integrated with the SX-200 EL and SX-200 ML systems, and designed with the power and performance needed to ensure satisfaction in the most demanding telemarketing environments. For maximum efficiency, all ACD personnel use SUPERSET display telephones programmed with special displays and softkeys. The SUPERSET display telephones are SUPERSET420, SUPERSET 430, SUPERSET 4015, SUPERSET4025, and SUPERSET 4150 telephones. The displays provide call status and progress messages; the softkeys give single-button selection of ACD features.

ACD - Path

The heart of the ACD TELEMARKETER feature is the ACD path, an innovative call routing design that guides incoming calls through the system. The path defines all information required for each type of call including how the system is to handle callers placed in a queue to wait for an agent. With 99 ACD paths in the system, customized routing is available to every conceivable type of incoming call. This centralization of routing parameters gives users unmatched flexibility when programming and adding new features.

Priority designations of 1 to 99 may be assigned to each path, allowing calls arriving on high priority paths to move directly to the front of the call queues. Higher priority paths are also given special treatment when placed in overflow queues. Lower priority calls in the same overflow queue maintain their position in relation to each other, but the system places them behind priority calls.

ACD - Positions

The ACD TELEMARKETER feature package structures the personnel handling ACD calls into a hierarchy of ACD positions. The ACD package supports three types of positions: senior supervisors, supervisors, and agents. ACD calls entering the system usually terminate on an agent position. Agents handling similar types of calls are arranged in agent groups. Supervisors and Senior Supervisors monitor agent and system performance, but do not handle ACD calls.

ACD - Displays

The ACD TELEMARKETER feature includes real-time displays via standard asynchronous datasets and ASCII terminals. Thirteen displays encompass every area of ACD operation. Path, group, and agent information is displayed in three categories: statistical analysis, current activity, and programming information. A system activity display provides a general overview of the status of the ACD system, including the number of agents logged in, the number of calls in the system, and general statistics on agent performance. Up to four users can access the password protected information simultaneously. Softkeys are provided for easy access to specific displays or for requesting printouts.

ACD - Longest Idle Agent

If multiple agents are free when an ACD call is presented to a group, the system sends the call to the longest idle agent. To select the longest idle agent, the system gives a number to the first agent to finish an ACD call. The next agent to finish an ACD call is given the next higher number, and so on. When a call arrives at the group, the system sends the call to the agent with the lowest number.

ACD - Mobility

ACD Agents and Supervisors are completely mobile. All ACD positions are linked to software rather than hardware. The system recognizes a login from any telephone programmed as an ACD position within the system and immediately transforms the set to the user's preprogrammed specifications.

ACD - Predictive Overflow

A key element of the ACD TELEMARKEETER feature is the predictive overflow used by the system to keep call queueing time to a minimum. The system performs a load calculation when each new call arrives at an agent group, or when the status of an agent changes. If the system predicts that a call will not be answered before the normal overflow time, it forces an immediate overflow.

ACD - Printed Reports

Printers are implemented for summary reports of paths, groups, and agents. Printed reports record times to the second for all categories, thus highlighting call handling efficiency and agent performance problems.

An agent shift record can be printed automatically whenever an agent logout occurs. This report summarizes the agent's performance for the shift duration. A path report provides total counts for traffic entering the path during any specified period, including totals for the number of calls answered, interflowed and abandoned. Similarly, group reports tally calls offered and answered, and supply a record of non-ACD calls placed and received by agents.

Printed Daily Reports include

- ACD Agent Daily Activity Report listing hourly totals by agent ID
- Agent Group Daily Activity Report with hourly totals handled by each agent group
- Path Activity Report with detailed statistics for all ACD calls.

Weekly and Monthly Summary Reports (if the Mitel Networks 6100 Contact Center Solutions application is used) include

- Agent Activity Summary Report with daily totals by ID and agent name
- Agent Group Summary Report listing daily totals by agent group
- Trunk Summary Report with daily totals of calls carried by a particular trunk
- Trunk Daily Activity Report with hourly totals of calls handled by individual trunks
- Path Activity Report listing daily totals by path.

ACD - Real Time Event

Allows a PC to report real time events of ACD activities. The system transmits call status messages to the host computer reflecting the changes of state on the line or on the device. The host computer with the Mitel Networks 6100 Contact Center Solutions application provides an enhanced form of ACD reports and statistics.

ACD - Recorded Announcements

Recorded announcements are used to tell callers about the progress of their call while waiting in the queue for the first available agent.

ACD - Sets

SUPERSET 4DN, SUPERSET 410, SUPERSET420, SUPERSET430, SUPERSET 4015, SUPERSET4025 and SUPERSET4150 telephones sets provide interactive displays and information to agent groups and individual agents. SUPERSET 4025, SUPERSET 4125, and SUPERSET 420 telephones may be used in the senior supervisor, supervisor, or agent positions with the ACD TELEMARKETER feature package. SUPERSET 4015 and SUPERSET 410 telephones may be used in the agent position only.

Automatic Number Identification (ANI) on Outgoing Trunks

The Automatic Number Identification (ANI) feature allows the system to identify a calling party to the far end device on an outgoing trunk. After the system has successfully dialed an external number on the trunk the system identifies the calling party by sending the calling party's extension number as tones or pulses on the trunk.

Automatic Number Identification (ANI) / Dialed Number Identification Service (DNIS) on Incoming Trunks

This feature allows the SX-200 EL and SX-200 ML systems to identify Automatic Number Identification (ANI) numbers and Dialed Number Identification Service (DNIS) numbers that are transmitted to the system on an incoming trunk. ANI provides the telephone number of the calling party, while DNIS provides the telephone number dialed by the calling party.

The SX-200 EL/ML systems can receive ANI and DNIS numbers on specific types of incoming non-DISA trunks. After receiving ANI and DNIS numbers for an incoming call, the system can then make the numbers available to other functions within the system. The system can be programmed to provide ANI and DNIS numbers to SUPERSET display telephones, to SUPERSET consoles, to SMDR printers, and to the MAI platform.

On a SUPERSET console, the ANI and DNIS digits for an incoming call are displayed after the call is answered. The ANI digits appear where the trunk information is normally displayed, and the DNIS digits overwrite the COS and COR fields on the console display. When ANI digits are not received, the trunk information is shown instead, and when DNIS digits are not received, the COS and COR fields are visible. By default, ANI and DNIS numbers are not displayed.

On SUPERSET display telephones, the display shows DNIS or ANI digits while the call is unanswered. After the user answers the call, the ANI digits are displayed. When COS - Display ANI Information Only is enabled, the SUPERSET telephone displays the ANI digits during both the unanswered and answered states. Whenever ANI or DNIS digits are not available for a call, the display shows the normal trunk information. By default, ANI and DNIS numbers are not displayed.

The system can be programmed to record ANI and DNIS digits in the SMDR reports. The digits are recorded at the end of the trunk SMDR record. Both ANI and DNIS numbers are recorded up to a maximum of 10 digits in length. By default, ANI and DNIS numbers are not recorded in SMDR reports.

Automatic Number Identification (ANI) on Outgoing Trunks

This feature is a mechanism that allows the system to identify a calling party on an outgoing trunk. The identifying information consists of the calling party's extension number which is transmitted (tones or pulses) on the trunk, after the system has successfully dialed an external number on that trunk.

Automatic Route Selection (ARS)

The ARS feature is part of the system software package. It automatically selects one of a preprogrammed (programmed during CDE) list of trunk routes every time an outgoing call is made. The routes are selected based upon the digits dialed, in order of cost (i.e., least expensive route first), and in accordance with the caller's toll restriction. The use of digit analysis and digit modification within the ARS package allows the system to recognize and modify any digit string which is dialed by the user, alleviating the need for the user to dial special trunk access codes, or to dial a different digit string for each of the various routes to the same destination.

The complete ARS package provides the following:

- **Alternative Routing** - automatically selects an alternate trunk route when the first choice is busy. Routes (e.g., tie trunks or WATS lines) are preprogrammed in an implied sequence of selection within the Route Lists Table.
- **Least Cost Routing** - enables the customer to capitalize on the cost benefits offered by each type of trunk by allowing the installation company to define, via the Route Plans and Route Lists Tables, the order in which the trunk groups are to be selected.
- **Toll Control** - allows the customer to restrict user access to specific trunk routes and/or specific directory numbers.
- **Overlap Outpulsing** - seizes a trunk and commences outpulsing as soon as sufficient digits have been received to identify the route.
- **Expensive Route Warning** - presents a tone to the user during call setup, and, if a SUPERSET 420, SUPERSET 430, SUPERSET 4015, SUPERSET 4025, SUPERSET 4125, SUPERSET 4090, or SUPERSET 4150 telephone is used, the message EXPENSIVE ROUTE appears on the LCD when the route selected by ARS is programmed as an expensive route.
- **Callback Queueing** - allows the user who encounters busy tone after dialing an ARS digit string (i.e., all trunks busy) to dial a callback access code, or, if a SUPERSET 420, SUPERSET 430, SUPERSET 4015, SUPERSET 4025, SUPERSET 4125, SUPERSET 4090, or SUPERSET 4150 telephone is used, to select CALLBACK, and be placed in a queue for the first available trunk.
- **Camp-on Queueing** - allows the user who encounters busy tone after dialing an ARS digit string (i.e., all trunks busy) to wait off-hook, or, if a SUPERSET 420, SUPERSET 430, SUPERSET 4015, SUPERSET 4025, SUPERSET 4125, SUPERSET 4090, or SUPERSET 4150 telephone is used, to select CAMP ON and remain off-hook until a trunk becomes free.
- **Return Dial Tone** - allows the system to simulate CO dial tone for customers who consider that its absence would confuse the users of their system.

The ARS feature is universal and is compatible with any numbering plan which may be employed by any public network.

Background Music

This feature allows the user of a SUPERSET multi-line telephone to have background music played through the set's speaker while the set is idle. The Music-on-Hold source provides the music. See Music-on-Hold.

BRI Card Support

The BRI line side supports video conference units, Group 4 FAX units, a PC Data Terminal with a BRI interface (internet access), and an Xpress Office 5232i for remote DNIC operation. The BRI trunk side supports Basic call and incoming call name and can be an access point for video conferencing, Group 4 FAX, internet access and Xpress Office 5232i. BRI Card Support requires Feature Level 2 or greater.

Broker's Call (Station Swap)

Broker's Call is similar to the Transfer With Privacy feature. It allows the user to speak privately with two separate parties. When the user hangs up, however, the two parties are disconnected.

Broker's Call With Transfer (Transfer With Privacy)

The Transfer With Privacy feature is similar to the Broker's Call feature by allowing the user to speak privately with two separate parties. When the user hangs up, however, the two parties are connected. Transfer with privacy interprets a flash as a swap. A conference cannot be formed by an extension with this feature enabled.

Busy Lamp Field

A Busy Lamp Field (BLF) on the Programmable Key Module indicates to the user the status (Idle, Busy, DND) of a line appearance for a device such as, normal stations, SUPERSET prime lines, logical lines, and trunks. Any SUPERSET telephone with line keys may be programmed to use BLF indicators.

The PKM 48 provides 48 additional BLF indicators to a SUPERSET 4025, SUPERSET 4125, or SUPERSET 4150 telephone. You can connect up to two PKM 48 devices to either of these sets.

The PKM 12 provides 12 additional BLF indicators to a SUPERSET 4025, SUPERSET 4125, or SUPERSET 4150 telephone. You can only connect one PKM 12 to a telephone.

For appearances of trunks, the indicator indicates the state of the trunk (Idle or Not Idle). For appearances of logical lines, the indicator indicates whether or not a call to the line will find the line busy. If the line is a multi-call line, the indicator indicates idle until there are no free Line Appearances to ring. If the line is a key line, the indicator indicates whether or not the line is occupied.

Calculator

SUPERSET 4150, SUPERSET 430, and SUPERSET 4DN telephones provide a basic, four-function calculator using the telephone keypad, display, and softkeys. The calculator has 2 modes of operation - General and Programmer. Once the calculator feature is accessed, the # key may be used to switch between the two modes. In the General mode the calculator allows for arithmetic operations and the telephone keypad is used as the numeric keypad. In the Programmer mode the calculator allows for integer arithmetic/logical operations in either decimal or hexadecimal.

Call Forwarding

The Call Forwarding feature allows the telephone user to redirect calls placed to the telephone set's extension number. The type of forwarding selected determines under what conditions the call is redirected.

The types of Call Forwarding available are

- Call Forwarding - Busy

Forwards all calls when the extension is busy. While the extension is idle, calls can be made and received as usual.

- Call Forwarding - Busy/ No Answer

Forwards all calls that are received when the extension is busy or are not answered within a selected time-out period. While the extension is idle, calls can be made and received as usual.

- Call Forwarding - Display Prime as Forwarder

This feature displays either the forwarder's prime extension number or the line on the forwarder's set display. If the feature is enabled, the prime extension number of the set that forwarded the call is displayed. When the feature is disabled, the logical line appears as the forwarder for all types of forwarding.

- Call Forwarding - No Answer

This feature forwards all calls that are not answered within a selected time-out period. Calls may be made and received normally.

- Call Forwarding - External

This feature forwards all calls received based on one of the conditions selected from above, to a personal speed call key, system abbreviated dial number, or a personal speedcall.

- Call Forwarding - Always

This type of forwarding is unconditional. All calls are forwarded to the programmed destination. The number to which the calls are forwarded is the only extension that can call the forwarding extension while Forwarding - Always is active. The extension can originate calls in the usual manner.

- Call Forwarding - Forced Call Forward

This feature allows a SUPERSET 4015, SUPERSET 4025, SUPERSET 4125, SUPERSET 4150, SUPERSET 410, SUPERSET 420, or SUPERSET 430 telephone user to force a dialled call to forward immediately rather than waiting for the ringing timeout. One application of this feature is to leave a quick voice mail message for someone who you know is not at their desk.

- Call Forwarding - Forward Call

This feature allows the user of a SUPERSET multi-line telephone which is ringing, to force the call to be forwarded to a pre-programmed forward destination. Users can forward both ringing calls and camped on calls. With a SUPERSET 4150 or SUPERSET 430 telephone, the user may view the calling party identity on the LCD display, and decide if it is to be forwarded or not, rather than having the system forward it automatically.

- Call Forwarding - I'm Here

This type of forwarding operates the same as Forwarding -Always, but it is activated from another extension. All calls are forwarded to the new location. The forwarded extension can originate calls in the usual manner.

- Call Forwarding - Internal / External Split.

This feature allows internal and external calls to be forwarded to different destinations. For example, internal callers can be forwarded to Voice mail, while external callers can be routed to an attendant. This allows for more professional call handling. Call Forwarding - Always, Call Forwarding Busy, and Call Forwarding - No Answer may have a different destination for internal and external calls. The extension can originate calls in the usual manner.

- Call Forwarding - Toggle Keys

Feature keys may be programmed as toggle keys for Call Forwarding - Always, Call Forwarding - Busy, Call Forwarding - No Answer, or Call Forwarding - Busy/No Answer. The toggle keys allows you to direct your call forwarding temporarily to another destination with a touch of a button. You may toggle back and forth between one forward destination and another without having to reprogram the call forwarding.

This is very convenient for people who leave their desk phone and use a cordless phone for short periods of time. In this case the user could press a Forward Always button on his desk phone when he leaves his desk and takes his cordless. After returning, he would press the Forward Always button again to return the forwarding to its normal state.

LIGHTWARE 19 Release 2.0 introduced tenant-based call forwarding. This allows the installer to assign common call forwarding destinations for Call Forwarding - Busy and Call Forwarding - No Answer to tenant groups in CDE Form 19. This feature is especially useful in the hotel environment where a one point entry will serve a large group of telephones.

Call Logging

Call Logging provides the telephone user with a log showing a list of all the calls to their telephone set. The log includes all calls answered and not answered, as well as, calls forwarded to another destination. The user can press the Call softkey to return the call.

Call Park from Single-line Sets

This feature allows users of single-line telephones to put a call on hold (parked) and then replace the handset. The call may be retrieved at the extension at which the call was parked, or from any other extension in the system. If Music-on-Hold is available, the parked party hears music. The parking extension may not originate or receive new calls until the parked call is retrieved. It can only access paging equipment.

Call Park from Multi-line Sets

This feature allows you to park a call from your prime line. After you park a call you can make or accept other calls from your prime line. This feature is available on SUPERSET 4015, SUPERSET 4025, SUPERSET 4125, SUPERSET 4090, SUPERSET 4150, SUPERSET 410, SUPERSET 420, and SUPERSET 430 telephones.

Call Park System Orbit

This feature allows you to park up to 25 calls in a parking orbit from any line on your display set or console. Your display shows the park access code and the orbit number. You can then page and inform the paged party where they can retrieve the call. After you park the call, your line is free to make or accept other calls.

Call Rerouting

This feature provides flexibility for the routing of incoming calls, attendant access, call interception, and routings for various features. Different types of calls can be routed to different answering points in DAY, NIGHT1, and NIGHT2 service for each tenant. Rerouted calls are processed differently than normal calls. The system considers rerouted calls to be important calls that must get through. Some features on the reroute point are ignored because of this.

Callback

The Callback feature allows the system to notify a caller when a busy device becomes free or when a set has been used after a no answer condition was encountered.

Callback - Busy allows a user who has encountered a busy destination (set, hunt group, or trunk group) to have the call completed when the destination becomes idle. The system continuously monitors the originating set or console and the destination. When the originating set is idle and the call can be completed, the system calls the originating set. When that set or console answers, it calls the destination.

Callback - No Answer allows a user, after dialing an extension which does not answer, to have the call completed after the called party uses the telephone. The system continuously monitors the originating set or console and the called set. When the called set goes off hook and then returns to idle, the callback is handled in the same way as Callback Busy. Up to 100 Callback requests may be active within the system at any time; however, a maximum of only 25 ARS Callbacks is permitted in these requests.

Campon

The Campon feature allows a device to indicate to a busy party that communication is desired, and to be connected when the party is free. Also, the user can make a continuing request for a trunk when the trunk group is busy, and be connected to a trunk when one becomes free.

If, when calling an extension, hunt group, or ARS, the destination is busy, the caller usually receives a tone for a predefined period and then camps on to the busy device. The type of tone indicates whether or not campon is allowed during the period, or is available at the end of the period. For some calls the period is skipped.

The busy called extension receives a tone alerting the party that there is a call waiting. See Campon Warning Tone. An extension can consult the first waiting party using the Swap Campon feature.

Campon may be initiated on a trunk group that has been programmed to give the Expensive Route Warning. See Expensive Route Warning.

For recall from Campon, see Recall.

Campon Priority Over Call Forward Busy

If an internal call to a set that is busy and has Call Forward - Busy (or Call Forward - Busy/No Answer) activated, the call is immediately forwarded. With this feature, the caller has the option of camping on to the busy set or allowing the forward to take place.

Campon Warning Tone

When a device sets Campon to an extension or hunt group, a warning tone is sent to the extension user over the current call. The warning tone can be programmed to repeat every 5 to 15 seconds.

Centralized Attendant

The Centralized Attendant feature allows an attendant or Subattendant on a system to answer calls that arrive at another interconnected system. This feature is a purchasable option and accompanies Centralized Voice Mail.

CENTREX Compatibility (Double Flash Over Trunk)

This feature provides the ability to send a double switchhook flash out over a trunk. Flashing over a trunk allows for the use of CENTREX features by telephones within the system. Callers must follow the instructions specified by the local central office concerning the use of double flash.

A CENTREX extension can be put on sofhold to dial another extension, by sending out a Flash Over Trunk followed by the digits of the extension. If the caller hears busy or ringing, the CENTREX extension can be put on sofhold again, and the Double Flash Over Trunk feature access code can be dialed. This sends out two flashes on the trunk, with one second between

the flashes. When the CENTREX service receives the double flash, it clears the ringing/busy tone. The caller returns to a talking state with the trunk that was on softhold.

The trunk must be in a trunk group in order to flash over the trunk and the feature can be used by telephones only. The feature only functions if one trunk is on consultation hold and cannot be used with a conference on consultation hold.

CENTREX Compatibility (Single Flash Over Trunk)

This feature provides the ability to send a switchhook flash out over a trunk. Flashing over a trunk allows for the use of CENTREX features by telephones within the system. Callers must follow instructions specified by the local central office concerning which access codes to dial, and when to wait for dial tone. After sending the flash over the trunk, the system will wait for dial tone from the central office, or for the Limited Wait For Dial Tone timer.

Speed Call: The Access Code for Flash Over Trunk, followed by digits which make sense to the local central office may be programmed into a Speedcall key, or a System Abbreviated Dial Number. The trunk must be in a trunk group in order to flash over the trunk. Any central office access code with an asterisk (*) in it must be entered as **.

CLASS (Custom Local Area Signaling Services) for Analog Telephones

CLASS (station side) for Analog Telephones allows the SX-200 EL or the SX-200 ML system to pass Calling Line ID digits and CLASS name information through to analog stations, such as display sets, that support Caller ID functionality. This feature supports a calling name and number display (if available) to a ringing set and to a set in talk state (a visual call waiting or campon). The CLASS message is also able to activate and de-activate the message lamp. To maintain privacy, the CLID information is cleared on checkout.

CLASS (Custom Local Area Signaling Services) for Digital Sets

Available on the SX-200 SPINE nodes and on the LS/CLASS Trunk cards in the SX-200 rackmount cabinets. The system receives Calling Line ID digits or CLASS name on incoming Loop Start (LS) CLASS trunks. The calling directory number or name is presented to SUPERSET display telephones, to SUPERSET 7000 and SUPERCONSOLE 1000 consoles, to SMDR printers, and to the MITEL Application Interface (MAI) platform package.

Class of Restriction (COR)

Fifty Class of Restriction (COR) groups are available in the system to give 50 different levels of outgoing call capabilities. Each extension, SUPERSET telephone, dataset, console or dial-in trunk is assigned a COR that defines the outgoing call privileges for that device. All devices with the same COR have the same outgoing call privileges. The Class of Restriction allows the system to restrict which trunks cannot be accessed by a user.

Class of Service (COS)

Each extension, trunk, SUPERSET telephone, dataset, ACD position, or console is assigned a Class Of Service (COS) which defines the features available for that device. All devices with the same COS have access to the same features. Fifty Classes Of Service are available in the

system to provide 50 different levels of feature accessibility. Each COS can have a name associated with it.

Clear All Features

An extension user may cancel all Call Forwarding, Do Not Disturb, and Callbacks Active at that extension.

CO Line Group Key

The CO Line Group key allows the selection of an idle CO line from a CO line group. The key accesses a group of CO lines without having a dedicated appearance for each line on the set. Toll control is handled by ARS. The LCD or LED indicator corresponding to the key has no function.

CO Line Key

The CO Line key originates and answers calls to or from parties outside the system. The key accesses a specific trunk directly. A CO line key may be shared by up to 32 sets, but only one may access it at a time. One other party can join in on a call on the line if the CO line is non-private, or privacy is released.

CO Line - Select Direct

This feature allows a direct access to a specific CO trunk which may or may not appear on the user's telephone set. This feature must be accessed through any internal line.

CO Line Type - Direct Access - Bypass Key System Toll Control

This feature allows an extension seizing a CO trunk with a line key to bypass the system dial tone and Key System Toll Control. Instead, dial tone from the CO is immediately received. This allows users to hear stutter CO dial tone on their CENTREX lines, indicating the presence of voice mail messages. Users may then access their voice mail or other CENTREX features or they may dial an external destination number.

Conference

This feature allows a set user to establish a conference of up to five parties (including the originating extension), without the assistance of the Attendant.

Conflict Dialing

The system can differentiate between conflicting extension numbers such as "52345" and "5234". This implies that extensions can be programmed as 1-, 2-, 3-, 4-, or 5 digit numbers with the first digits being identical. The system selects the shorter extension number if the next digit is not dialed within a preselected time. A conflict exists between two extension numbers if the first number is contained in the second number, starting with the first digit. For example, 1234 conflicts with 12345, but 1234 does not conflict with 123 (123 conflicts with 1234). Users could experience slower performance with conflicts.

Consoleless Operation

The system may be operated without the use of an Attendant Console. Under these conditions all features associated with the console are not available. SUPERSET 3DN, SUPERSET 4DN, and SUPERSET 4150 telephones may be used as Subattendant positions. These may switch the system to night service. See Night/Day Switching. Subattendant positions can also be given enhanced call handling and recall capabilities.

Contact Monitor

This feature allows a station line circuit to be used for monitoring an alarm contact. The contact to be monitored is connected across Tip and Ring of the circuit. When the contact closes, a call is originated by the station line circuit and the call is directed to its tenant's Dial 0 or Priority Dial 0 Routing Point. The system handles the call as a call reroute.

Customer Data Entry (CDE)

Customer Data Entry is a full screen application, using softkey prompts and simple graphics for entering and changing customer programming. Enter customer data from a terminal via the RS-232C connector on the rear of the cabinet, or from an Attendant Console. CDE can also be performed from a remote location, using a terminal connected to the system via modems.

Customer Data Entry - Default Data

The system is preprogrammed with default Class-Of-Service (COS) Options and Class-Of-Restriction Options; if no alternates are programmed, the system defaults to the preprogrammed data. The Feature Access Codes can be entered during Customer Data Entry.

Customer Data Entry - Range Programming

This feature allows range programming for blocks of extensions. By entering a range of equipment numbers, one may assign extension numbers, COR, tenant, and COS to a selected block of equipment numbers. The start extension number and defaults for the other values are entered by the programmer. The extensions are assigned sequentially starting at the entered value, and the COS, tenant and COR are assigned to the entire group.

Customer Data Print

This feature displays the current programming of the SX-200 EL/ML systems. Each or all of the CDE forms may be printed, one at a time, in a presentable format.

Data: Abbreviated Dial For ADL Calls

An ADL user can originate an ADL call using a System Abbreviated Dial number.

Data: Account Codes

Verified and unverified Account Codes can be applied to internal, external or long distance data calls. The Account Code appears in the Data SMDR and trunk SMDR records. Internal data

calls generate a Data SMDR record only; external data calls generate both a Data SMDR and a Trunk SMDR record.

Data: Associated Data Line (ADL)

This feature allows a telephone to originate and disconnect a data call. The association is between a telephone (used for dialing or disconnecting the call), and the dataset the call is switched to once, the setup is complete. The user can establish a basic ADL call from an industry-standard telephone or a SUPERSET telephone by dialing an access code and the number of the destination. The Associated Data Line operates with either asynchronous or synchronous devices.

The data destination of any data call can be predetermined via the Hotline feature (see ADL Hotline). Industry-standard DTMF and rotary telephones, SUPERSET telephones can be used in ADL calls. Either the originator or destination can terminate the data call. Data destinations include

- Data station extension number
- Data hunt group access code
- Modem hunt group access code followed by ARS digit string.

Included with originate/disconnect capabilities of ADL are the following:

- Data call originate using the Speed Call key or Abbreviated Dial
- ADL queuing
- Data call disconnect using the Speed Call key or Abbreviated Dial, or the Disconnect or Call/Attn key.

Data: ADL Hotline

This feature establishes a data call between two preassigned data devices when the user dials the ADL access code from the associated telephone.

Data: ADL Speed Call Originate

An ADL user can originate an ADL call using a personal Speed Call number.

Data: Associated Modem Line (AML)

This feature allows voice only calls, data only calls, simultaneous voice/data calls, and alternating voice/data calls through the system. A standard ONS voice port is associated through CDE programming with one or more SUPERSET telephones. This ONS port is connected to data terminal equipment (DTE) via a modem. Data calls may be set up using the associated SUPERSET telephone.

Data: Auto Answer

This feature supports automatic answering destination data devices. When the destination data device detects ringing, it answers, then signals to the calling device that it is ready to receive data.

Data: Automatic Data Route Selection (ADRS)

Outgoing trunk data calls are processed by the same Automatic Route Selection (ARS) system as voice trunk calls. See Automatic Route Selection.

Data: Hunt Groups

Datasets can be assigned to a Data Hunt Group. The system supports both Terminal and Circular hunting. See Hunt Groups.

Data: Modem Pooling

Modem Pooling is a data application feature using voice communication lines. Modem pooling permits communication between modems and DATASET 2100 Series datasets. Each pooled modem consists of a modem and a dataset. The dataset connects to a Digital Line Circuit, and communicates with datasets within the system. The pooled modem connects to an ONS or OPS Line Circuit, which communicates directly with internal modems, or with external modems via trunks.

Data: Modem Pooling Queuing

Modem Pooling callers who encounter a busy modem pool hunt group, destination dataset, data hunt group, or trunk group can queue for it.

Data: Peripherals

The system supports several different data devices; and provides several data support devices for use with data devices.

Mitel Networks data devices are proprietary limited-distance modems that provide data facilities for terminals, digital SUPERSET telephones, and other types of data devices. These data sets serve as the interface between the DNIC circuit in the PBX, and the data devices connected to the system, transmitting data and control signals over a single twisted pair of wires. The datasets are available in two series - DATASET 1100 series and DATASET 2100 series.

DATASET 1103 Standalone supports asynchronous data communications at rates from 110 bps to 19.2 kbps. The data sets are RS-232C compatible, provide end-to-end error correction, auto-baud detection and auto-parity generation.

The DATASET 1100 series is available in two options:

- DATASET 1103 Standalone
- MILINK Data Module.

DATASET 2103 Standalone supports asynchronous data communications from 110 bps to 19.2 kbps, and synchronous data communications at rates from 1200 bps to 19.2 kbps. In asynchronous mode this data set has the same operating characteristics as the DATASET 1100 series. In synchronous mode, the DATASET 2103 uses X.31 protocol.

All datasets interface to a DNIC circuit through a single pair.

Data: Security

Data Security protects an established data call from intrusion or warning tones, such as Campon or Override, that would interfere with the data signals on the line. Any extension with Data Security in its COS cannot be overridden or receive Campon tone; it may be camped on to, but is secure against any form of audio intrusion.

Data: Station Message Detail Recording (Data SMDR)

The Data SMDR feature produces a detailed record of all internal and external data calls. The printout format is similar to the trunk SMDR record and includes “data call indicator”, “type of data call” and “reason for disconnect” fields. Data SMDR records differ in appearance from voice SMDR records. This allows a call costing device to maintain separate totals for data and voice calls.

Data: Station Queuing

Data Station Queuing is similar to the Campon feature provided for telephones. A user encountering a busy dataset or Data Hunt Group can camp on and remain in the queue until the destination becomes available. The user may also terminate the call at any time.

Data Transceiver (DTRX)

The Data Transceiver (DTRX) allows the data user to set up a data call from a data terminal (DTE). The system has four DTRX channels; four users can communicate with the DTRX simultaneously. When the requested call is established, the DTRX is dropped, making it available for other data callers. Users requesting a busy destination are queued until the destination is available. Up to 20 callers can queue. Subsequent callers requesting destinations that are busy are sent the message “System Busy, Try Again Later”. When all DTRX channels are busy, callers queue for DTRX service. Up to 28 callers can queue, including those queued for destinations. Subsequent callers are prompted to try again later.

Data: DTRX Call by Name

This feature allows the user to call a data hunt group or modem pool hunt group by name instead of number.

Data: DTRX Call Originate/Disconnect

The DTRX Call Originate/Disconnect is initiated and controlled from a terminal keyboard.

Data: DTRX Help

The Data Transceiver (DTRX) provides on-line help.

Data: DTRX Hotline

A dataset can be programmed to connect automatically to a predetermined destination when a user originates a DTRX data call.

Data: DTRX Messages

The Data Transceiver (DTRX) provides a number of messages to inform the user of call progress and error conditions.

Daylight Savings Time Adjustment

This feature allows you to program the system to automatically set the system clock

- ahead for daylight savings time
- back for standard time.

You program the month, day, and hour of the time changes, and the length of the time adjustment through CDE each year. The system automatically performs the time changes. A system reset is not required for a time change to take effect.

Device Interconnection Control

The Device Interconnection Control feature provides a means of disallowing connection between devices of different types. The feature is primarily intended to control trunk interconnections but applies to other devices as well. This is intended to provide a method of meeting interconnection restrictions imposed by various regulatory authorities. The checks apply when a device calls another device, when a transfer (supervised or unsupervised) is attempted and when the console attempts to perform operations on devices.

See Flash Control for details on controlling the ability of extensions to flash when extensions are involved with trunk calls.

Dial Tone Disable

Assigning this feature to a dial-in trunk suppresses dial tone on an incoming trunk call. If this feature is assigned to an extension, the extension does not receive dial tone when dialing is initiated.

Dial Tone - Discriminating

An extension that has a feature enabled that prevents calls from ringing the extension hears a distinct dial tone (350/440 Hz, 400 ms on, 100 ms off for six cycles, followed by continuous tone) when going off-hook to make a call. These features include Do Not Disturb, Call Forwarding - Always, and Call Forwarding - I Am Here.

Dictation Trunks

This feature indefinitely extends the dialing stage on a trunk to allow tone-to-pulse or pulse-to-tone conversion of all digits dialed during a trunk call. Without the feature, only DTMF signaling is possible from extensions with DTMF telephones connected.

DID/Dial-in/Tie Intercepts

This feature allows a customer to specify that all DID and Dial-in Tie Trunk calls directed to a busy extension (or one which does not answer within a selected time period) are redirected to a call rerouting point. As well, the trunks can be programmed to be redirected immediately or to be redirected under certain error conditions. See Recall, to see how this fits in with general recall operation.

Digit Translation

The SX-200 EL and SX-200 ML systems may be programmed to provide one of four digit translation plans for rotary telephone sets. The translation plans specify the number of pulses to be outpulsed for each digit dialed.

Direct-in Lines (DIL)

This feature allows non-dial-in trunks to ring specific answering points, rather than the Attendant Console. The answering point may vary with Night Service changes. An answering point may be one of the following in addition to a console or LDN:

- An ACD path
- An extension number (industry-standard telephone, SUPERSET telephone, logical line)
- A hunt group access code
- A modem pool access code
- A night bell access code
- A system speed dial number to route to a Central Attendant at another system.

Direct Station Page/Busy Lamp Field

This feature allows you to direct a page with a DSS (Direct Station Select) softkey from a telephone to a selected telephone station.

Direct Station Select (DSS) Key

The Direct Station Select (DSS) Keys on a multi-line SUPERSET, or on a Programmable Key Module functions together with the adjacent Busy Lamp Field (BLF) indicator. While the BLF appearance indicator monitors the status of another device, the corresponding DSS key can be used to call, and transfer calls to that device. The DSS key operates when the appearance device is

- **Idle** - pressing the DSS key will initiate a call to the appearance device
- **Talking to another party that can be put on soft hold** - pressing the DSS key will put the other party on consultation hold, and connect the DSS key user to the appearance device
- **Listening to Dial Tone** - pressing the DSS key will connect the 2 parties
- **Dialing** - pressing the DSS key will connect the 2 parties (dialing will be suspended).

The DSS key is inoperable in all other states. For example, if the appearance device is talking to one party with another party on soft hold, the DSS key will have no effect.

Direct Station Select/Busy Lamp Field (DSS/BLF)

The DSS/BLF feature allows a SUPERSET telephone to have DSS keys and BLF LCDs. The LCDs indicate the status of each associated telephone. A DSS key is used to call, and connect calls to a device. The BLF indicator corresponding to the DSS key indicates the busy status of the device.

Direct Station Select/Busy Lamp Field (DSS/BLF) Call Pickup

DSS/BLF Call Pickup allows you to pickup a held or ringing call from a selected directory number (DN) with a DSS (Direct Station Select) key from a multiline SUPERSET telephone or from a Programmable Key Module. Enabling the system option DSS/BLF Call Pickup enables the BLF lamp to indicate the state of a DN instead of the state of the telephone set. The BLF lamp flashes differently to indicate a held or ringing call.

Direct Station Select/Busy Lamp Field (DSS/BLF) Interface Unit

The Direct Station Select/Busy Lamp Field (DSS/BLF) Interface Unit allows you to associate up to two PKM 48 devices with an attendant console. Each PKM 48 provides the attendant console user with 48 DSS/BLF keys.

The DSS/BLF Interface Unit uses a separate line connection to a DNIC port. You attach the PKM 48 devices to the DSS/BLF Interface Unit and associate the PKM 48 devices with the attendant console through Customer Data Entry (CDE). You can attach up to two PKM 48 devices to the DSS/BLF Interface Unit, for a maximum of 96 DSS/BLF keys.

Direct to ARS

This option allows a standard telephone to be routed directly to ARS without dialing the ARS access code, and for other devices to be routed after dialing a valid account code. The system automatically dials up to five digits for the extension.

Direct Trunk Select

This feature gives the user direct access to an outside trunk for both incoming and outgoing calls without using trunk access codes. The trunk is assigned to a line appearance of the telephone through CDE programming. Telephones having the direct trunk select feature can be programmed for ring, delayed ring, or no ring.

Direct Trunk Select calls bypass the system's Automatic Route Selection feature and are therefore unaffected by COR (toll control). The user can enter an account code while in an established call.

Disconnect Alarm

This feature serves as a security feature by turning on an alarm when a SUPERSET telephone is unplugged.

Display Caller ID on Non-Prime Lines

Prior to LIGHTWARE 19 Release 2.0, users manually identified the caller ID on ringing non-prime lines with the use of the SUPERKEY on their display telephone. Now, set users can automatically see the caller ID on non-prime lines.

Display Keys

This feature allows users of SUPERSET display telephones to display the function of certain keys on their sets.

Do Not Disturb (DND)

The Do Not Disturb feature allows a telephone user to block incoming calls from ringing the telephone. It also prevents incoming Directed and Group Paging announcements from occurring over the set speaker. Outgoing calls are not affected.

Callers to a telephone with Do Not Disturb active receive reorder tone. The message DO NOT DISTURB appears on display sets. The system can be programmed to reroute such calls to a predetermined answering point. Consoles and SUPERSET 4150, SUPERSET 430, and SUPERSET 4DN telephones can override Do Not Disturb when COS 500 (Override) is enabled, provided that COS Option 238 (Override Security) is disabled in the called set.

DTMF-To-Rotary Dial Conversion

This feature automatically converts DTMF tones from DTMF equipment to rotary dial outputting on outgoing trunks that have been programmed as rotary dial trunks.

Emergency Call Handling

This feature allows you to remove call blocking for emergency calls by designating digit strings (for example; 911 or 8888) as emergency calls in ARS programming.

Emergency call handling ensures that an emergency call is allowed for all stations. Exceptions include Hotline telephones or Receive Only sets. Conditions are listed in the Program Feature description for Emergency Call Handling. Because you define the emergency call digits defined in ARS and Toll Control, emergency call handling is not restricted to 911 calls. This permits emergency call handling in areas where 911 service is not available or where the emergency code is another set of digits.

Emergency Calls (911) - Detection and Reporting to Attendant Consoles

This feature alerts the attendant if an extension user places a 911 call and the feature identifies the extension that placed the 911 call. With this information, the attendant is in a position to provide assistance or to direct emergency services (for example, police or ambulance personnel) to the extension where the call originated.

When a 911 call is placed from an extension, this feature generates an audible alarm at the console. If the console is idle, the console display will identify that a 911 call has been made and, if you have specified the physical location of the extension in the Comments field of Form

9, the location of the extension is displayed. If you program the physical location, the tenant information will not be displayed. All consoles are notified of a 911 call regardless of their tenant group.

The system also generates maintenance logs for 911 calls:

- When the system detects a 911 call, it generates a log that identifies the extension number of the set that placed the 911 call.
- If an attendant clears a 911 alarm the system generates two logs. The first log identifies the attendant console that cleared the 911 alarm. The second log identifies the extension number of the set that placed the 911 call.

Note: This feature is not supported with a Centralized Attendant. If a 911 call is detected, ready to be delivered to a trunk, ONLY attendants ON THE SAME system as that trunk will receive the 911 reports/alarms.

Emergency Calls (911) function with the following programming:

- Attendant Display of System Alarms enabled, to allow alarm information to be displayed on an attendant console
- Attendant Audible Alarm enabled, to allow audible notification of 911 and Lockout alarms at an attendant console
- Delimiters programmed, to strip off digits that precede the 911 digit string if ARS programming adds
 - ISDN gateway digits for "Outgoing Call Characteristics" or "Call by Call" service parameters
 - An access code for network routing
 - A carrier code.

Note: To have the 911 call detected at the console one must program the delimiter *4 before the ISDN gateway digits in the "Digits to be Inserted" field in the "ARS: Modified Digit Table" to start deleting digits and to stop deleting digits.
Note that the *4 number sequence also stops and starts the modified digits from appearing in the SMDR records.

- ARS programmed, so that the digit sequences 9911 and 911 both outpulse 911 on the trunk.
- If the Hotel/Motel Feature option is enabled, and if it is a requirement that 911 calls be made from all rooms, the following must be programmed:
 - "Outgoing Call Restriction" disabled
 - "Vacant /Reserved Room Default Call Restriction" not set to INTERNAL
 - "Occupied Room Default Call Restriction" not set to INTERNAL.

Emergency Calls (911) - Detection and Reporting to Display Sets

This feature presents an audible alarm and a visual signal to the display set when an extension user places a 911 call or causes the handset to go offhook:

- The alarm consists of a distinctive ringing cadence (approx. 0.6 seconds on and 0.6 seconds off) when the set is on hook, idle, ringing, or in the talk state. The volume of the alarm can be set with the COS Option 618, Alarm Audio Level for Sets.

- The visual signal consists of a flashing LED on the alarm key. Pressing the alarm key or Superkey provides the details of the alarm; the user's extension number and location, e.g., Extension 2056, Room 212. With this information, the user of the display set can provide assistance or direct emergency services (for example, police or ambulance personnel) to the extension where the call originated.

Emergency Calls (911) - Reporting to PSAP

This feature allows you to assign a Customer Emergency Services Identification (CESID) number to an extension. For a call made to 911, the SX-200 system transmits the extension's CESID number to the public network. Where local networks are equipped with a 911 Selection Router, the CESID will be used to route the call to the Public Access Answering Point (PSAP). When the call reaches the PSAP, the CESID will be transmitted to the PSAP ALI database which will allow the dispatching system to show the location information associated with the CESID, for example street address, station number and room number. The CESID functionality requires the PRI card or the ISDN PRI Application Software Release 6.0 or greater software.

Expensive Route Warning

A trunk route can be programmed to give an Expensive Route Warning of three short tones. On SUPERSET display telephones and the SUPERSET Console, the LCD displays a message. The user can continue with the call or hang up and try again later when a less expensive route may be available. SUPERSET display telephones have the additional option of camping on to wait for a less expensive route or placing a callback on a less expensive route.

FAX Tone Detection

FAX Tone Detection allows an incoming FAX call on an automated attendant trunk to be detected automatically and routed directly to a FAX destination. You must purchase the FAX Tone Detection and the Automated Attendant feature.

Feature Keys

The programmable line keys on multi-line SUPERSET telephones and Programmable Key Modules that are commonly used for speedcall and line appearances, may also be used for feature activation; the user simply presses a feature key.

The feature keys available on SUPERSET 4015, SUPERSET 410, and SUPERSET 3DN telephones include

- Speedcall
- *Forward Always (not available on the SUPERSET 3DN telephone)
- *Forward Busy (not available on the SUPERSET 3DN telephone)
- *Forward No Ans (not available on the SUPERSET 3DN telephone)
- *Forward Busy/No Ans (not available on the SUPERSET 3DN telephone)
- *Forward All
- Account Code
- *Do Not Disturb

- *Auto Answer
- *Music
- Direct Page
- PA Paging
- Call Park / Remote Retrieve (not available on the SUPERSET 3DN telephone)
- Call Pickup
- Campon (I Will Wait)
- Callback
- Swap (Trade Calls)
- Privacy Release
- Override (Intrude)
- Night Answer
- Headset Mode
- Handset Mute (not available on the SUPERSET 410 telephone)
- Forward Call
- ** Single Flash
- ** Double Flash
- *Record a Call (not available on the SUPERSET 410 and SUPERSET 3DN telephone)
- Release
- System Park (not available on the SUPERSET 410 and SUPERSET 3DN telephone).
- *Voice Mail (not available on the SUPERSET 3DN telephone).

For the feature keys above marked with an asterisk (*), an indication is given on the adjacent LCD display when the feature is active. For the feature keys above marked with two asterisks (**), the adjacent LCD or LED indicators are inoperative. For the remaining feature keys listed, an indication on the adjacent LCD or LED indicator indicates when the feature becomes available to the user. The LCD indicator for Direct Page is not used.

Fewer Feature Keys are available on the SUPERSET 4025, SUPERSET 4125, SUPERSET 4150, SUPERSET 420, SUPERSET 430, and SUPERSET 4DN telephones because most features are provided via softkeys.

The Feature Keys available on a SUPERSET 4090, SUPERSET 4025, SUPERSET 4125, or SUPERSET 420 telephone include

- Alarm (not available on SUPERSET 4090 telephones)
- Speedcall
- Forward Always
- Forward Busy
- Forward No Ans
- Forward Busy/No Ans
- Forward All

- Call Park / Remote Retrieve (SUPERSET 4000 series sets)
- Account Code
- Do Not Disturb
- Auto Answer
- Music
- Direct Page
- PA Pager Access
- Privacy Release
- Intrude (Override)
- Night Answer
- ** Single Flash
- ** Double Flash
- Release
- Line Privacy
- Call Pickup
- Call / Attn
- Data Disc
- Callback
- Callers (not available on SUPERSET 4090 telephones)
- Forward Call
- Headset Mode
- Handset Mute (not available on SUPERSET 420 telephones)
- Group Listen (available on only SUPERSET 4000 series sets)
- Record a Call (not available on the SUPERSET 420 or SUPERSET 4090 telephones)
- System Park
- Voice Mail.

For the feature keys listed above and marked with two asterisks (**), the adjacent LCD or LED indicators are inoperative.

The Feature Keys available on SUPERSET 4150, SUPERSET 430, and SUPERSET 4DN telephones include

- Speedcall
- Forward Always (not available on SUPERSET 4DN)
- Forward Busy (not available on SUPERSET 4DN)
- Forward No Ans (not available on SUPERSET 4DN)
- Forward Busy/No Ans (not available on SUPERSET 4DN)
- Forward All
- Do Not Disturb

- Auto Answer
- Call Park / Remote Retrieve (SUPERSET 4000 series sets)
- Direct Page
- ** Single Flash
- ** Double Flash
- Headset Mode
- Handset Mute (not available on SUPERSET 430 or SUPERSET 4DN telephones)
- Group Listen (available on only SUPERSET 4000 series sets)
- VM Prompts (not available on SUPERSET 4DN telephones)
- System Park (not available on SUPERSET 4DN telephones)
- Record a Call (not available on the SUPERSET 430 or SUPERSET 4DN telephones)
- Alarm (not available on SUPERSET 4DN telephones)
- Callers (not available on SUPERSET 4DN telephones)
- Call Block (not available on SUPERSET 4DN telephones).
- Voice Mail.

For each of the keys listed above and not marked with two asterisks, an indication on the adjacent LCD or LED indicator is provided when the feature becomes active. For the feature keys listed above and marked with two asterisks (**), the adjacent LCD or LED indicators are inoperative.

Flash - Calibrated

Users of industry-standard telephones access many system features using a hookswitch flash. Calibrated Flash allows the system to consistently create the proper flash time thus preventing confusion between flash and hang up attempts. On rotary dial sets, the user sends a calibrated flash by dialing the digit "1". On DTMF sets equipped with a flash key, the user presses this key to send a hookswitch flash to the system.

Flash Control

This set of options limits the use of Consultation Hold (hookswitch flash) under certain conditions when an extension is in a call with a trunk or attempts to establish a call with a trunk.

Flash On Incoming Trunk allows extension users to put an incoming trunk on Consultation Hold. This enables the trunk call to be transferred, held, or added to a conference. The option does not apply when the extension is talking to a DISA trunk that has dialed into the system.

Flash On Outgoing Trunk is similar to the previous option but it applies to outgoing trunks.

Cannot Dial A Trunk After Flashing prohibits the extension user from accessing a trunk, through dialing or picking up a trunk on hold at another extension, while a consultation hold is in progress. The option does not apply to industry-standard telephones with Broker's Call or Broker's Call With Transfer in their COS, or when picking up trunk calls that are ringing at another extension.

Cannot Dial A Trunk If Holding Or In Conference With A Trunk prevents devices from dialing a trunk call or picking up a trunk from another extension while another trunk is in a call (conference or two party) on Consultation Hold. This option does not apply to industry-standard telephones with Broker's Call or Broker's Call With Transfer in their COS.

Flash Disable

An extension can be inhibited from using all services requiring the use of the hookswitch flash. For SUPERSET telephones, this prevents the extension from putting a call on Consultation Hold.

Flash For Dial 0 (Attendant)

An extension can be set to ring the Dial 0 routing point (usually the Attendant) automatically if a transfer is attempted while in an established call.

Flash For Waiting Call

This feature allows a user to place a call (2-party or multi-party) on consultation hold and connect to a waiting call. This is accomplished via a hookswitch flash. See Campon Warning Tone of this guide for information on allowing the telephone to receive an audible notification of waiting calls.

Flash Timing

The Flash Timer is a system wide programmable item. Its value applies to all industry-standard telephones in the system. The minimum flash timer is 200 ms. The flash timer can be programmed from 200 to 1500 ms.

Forward Campon

Calls that camp on to a multi-line SUPERSET telephone can be selectively forwarded to the telephone's call forwarding destination. When a party camps on to a busy telephone that has call forwarding programmed (it may be active or inactive), the person at the busy telephone can press a softkey or the FORWARD CALL feature key to forward that waiting party to the call forwarding destination.

Group Listening

Group listening allows a user of a SUPERSET 4025, SUPERSET 4125, or SUPERSET 4150 telephone to carry on a conversation using the handset while allowing others nearby to listen to the far end voice over the telephone set's speaker. The microphone is disabled in group listening mode.

Handset Mute

This feature allows you to mute the handset microphone during an off-hook conversation. You disable or enable the handset microphone during a conversation by pressing the HANDSET MUTE key (toggle action). The Handset Mute feature is programmable on the SUPERSET 4015, SUPERSET4025, and SUPERSET 4150 telephones.

Handset Receiver Volume Control

This feature enables the user of SUPERSET telephones to adjust the volume of the set's handset receiver. The handset receiver volume is independent of the set speaker.

Handsfree Announce

When paging to a set that is in handsfree conversation, the paging set receives a burst of busy tone. The paged set can press a "RESPOND" key to answer the page (the paging party has no indication until the paged party speaks).

Handsfree Answerback to a Directed Page

This feature allows users of SUPERSET 4025, SUPERSET 4125, SUPERSET 4150, SUPERSET 410, SUPERSET 420, and SUPERSET 430 telephones to respond handsfree to a directed page. In order to respond to a directed page handsfree, the user must turn on the set's microphone lamp in advance. Then, if a directed page is broadcast over the users set, the set microphone is activated allowing the user to speak handsfree to the calling party.

Note that the SUPERSET 3DN and SUPERSET 4DN Auto-Answer for Directed Page Calls feature provides a similar type of functionality for SUPERSET 3DN and SUPERSET 4DN telephones.

Handsfree Operation

This feature enables users of SUPERSET 4025, SUPERSET 4125, SUPERSET 4150, SUPERSET 410, SUPERSET 420, SUPERSET 430, SUPERSET 3DN, and SUPERSET 4DN telephones to have a telephone conversation without lifting the handset.

Headset Mode Feature Key

You can equip SUPERSET telephones with headsets. This feature allows you to turn headset operation on and off with a feature key. SUPERSET 401+ and SUPERSET 4001 telephones do not support this feature

Headset Operation

SUPERSET telephones can be equipped with headsets. The headset user answers incoming calls by pressing the line select key or the SPEAKER ON/OFF key and hangs up by pressing the cancel key or hangup softkey.

Customers using the dedicated headset jack on SUPERSET 4015, SUPERSET 4025, SUPERSET 4125, or SUPERSET 4150 telephones will automatically go to headset mode when a non-amplified headset connects to the dedicated headset jack of that telephone.

Users of SUPERSET 4025 (Rev level G.1 or greater), SUPERSET 4125 (Rev level C.1 or greater) and SUPERSET 4150 (Rev level G.1 or greater) telephones can answer a call with the handset while the telephone is in headset mode. This allows a person to answer a call quickly, when limited time does not allow the user to put a headset on. These telephones also

support a single key toggle (the Handset Mute key) between the handset and the headset receivers while the set is in the talk state.

The user can combine headset operation with the Auto-Answer feature for complete handsfree operation. Auto-Answer is available to all SUPERSET telephones (excluding SUPERSET 4090, SUPERSET 401, and SUPERSET 4001 telephones) when the telephone is in headset mode. Headsets used with SUPERSET 400 series telephones must be externally powered (amplified). Headset operation is not supported on the SUPERSET 4001 telephone.

Headset Operation (Amplified Headset)

You can equip SUPERSET telephones (excluding the SUPERSET 4001 telephone) with amplified (externally powered) headsets instead of handsets. You answer incoming calls by pressing the line select key or the SPEAKER ON/OFF key and hang up by pressing the CANCEL key or HANGUP softkey. You can combine headset operation with the auto-answer feature for complete handsfree operation.

Headset User Control

The SUPERSET 4000 series sets have a separate headset jack, so the handset and headset can both be plugged in. When a headset is plugged in, the set directs the speech path to the headset and disables the handset microphone. This feature is controlled through either a feature access code or feature key. To restore to handset operation, you separate the quick-disconnect connector or unplug the headset from the dedicated headset jack.

Headset with In-Line Switch Operation

SUPERSET 4000 telephones can be equipped with headsets that have an in-line switch. You can use this in-line switch to

- Answer an incoming call
- Terminate a call
- Mute the headset microphone.

You can combine headset operation with the auto-answer feature for complete handsfree operation.

Hold

This feature enables the set user to put the current call on hold and replace the handset or use the set for other calls. While the call is on hold, the user can select all features usually available on the set. The call on hold can be retrieved at the telephone that placed it on hold or at another telephone. This hold feature differs in operation from the Temporary Consultation Hold that occurs during a Call Transfer. See Transfer. See Add Held and Auto-Hold for set hold features. See also Attendant Hold Positions.

Hold Reminder

This feature reminds a user that there is a call on hold at the set. The user hears a single burst of tone at regular intervals until the call is retrieved from hold.

You can program the length of time that the system waits before providing the first reminder tone, as well as the time interval between the reminder tones.

Holiday Messages

SUPERSET telephones can display a holiday message at Christmas and New Year's. Each minute, the holiday message alternates with the usual time and date message that appears on the SUPERSET telephone display.

Hot Line

Individual sets can be programmed through CDE as hot lines. When the caller goes off hook, the system automatically dials a preprogrammed internal or external number. This feature is typically used for accessing taxi dispatchers or help desk operations.

Hotel/Motel (Lodging)

The hotel/motel feature package integrates standard system features with custom hotel/motel features. The system can also interface with a property management system (PMS). The hotel/motel and property management features are purchasable options.

The SX-200 EL or SX-200 ML system with LIGHTWARE 17 or greater software can operate with either the Hotel/Motel Package or the Property Management System package, but not both packages on the same system.

The Hotel/Motel feature package is designed specifically for use in the hotel environment. The features facilitate guest-related activities such as checking guests in and out, providing automatic wake up calls and taking messages. The Hotel/Motel feature package can be used to configure the telephone activities that guests are allowed (such as blocking calls between rooms) and to record what use is made of room telephones. It also assists with the administration of hotel activities such as keeping an accurate record of room occupancy and tracking housekeeping activity and status.

Hotel/Motel - Attendant Console Guest Room Softkey

The Attendant Console Guest Room softkey feature gives access to the Hotel/Motel features available at the Attendant Console. The Guest Room softkey accesses

- Room Number Selection
- Audit Printouts
- Room Status Summary Displays.

From this level, individual rooms can be selected. After selecting a room, the features available are

- Message Waiting Setup, Cancel and View
- Do Not Disturb Setup and Cancel
- Message Register Clear
- Automatic Wakeup Setup and Clear

- Room Status Change
- Call Restriction Change
- Room Number Selection.

On the display, the following information appears for the selected room:

- Room Number, COS, COR, and Name
- Room Status
- Maid In Room Status
- Room Call Restriction Status
- Room Do Not Disturb Status
- Room Message Waiting Status.

Hotel/Motel - Attendant Message Register Audit

This feature allows the Attendant to print the message register for all rooms with a message register count greater than zero. These rooms are listed in the audit report in order of room number (lowest to highest). See Message Register.

Hotel/Motel - Attendant Message Waiting Setup and Cancel

A message waiting indication can be left for a guest room. The setting and clearing of a message waiting for a room can be recorded on a system printer. A single line printout is generated, giving the room number, date, time and status change. See Single Line Reports.

Hotel/Motel - Audits

An Audit is a printed report that gives a record of guest room activities or conditions. There are several types of audits. Most are requested by the Attendant, but one (the Auto Room Status Conversion/Auto Wakeup Print) is programmed to be printed automatically each day.

The kinds of audits available are

- Message Register
- Room Status
- Room Type
- Wakeup
- Wakeup/Room Condition.

Message Register Audit: This feature allows the Attendant to print the message register for all rooms with a message register count greater than zero. These rooms are listed in the audit report in order of room number (lowest to highest). See Message Register.

Room Status Audit: This feature allows the Attendant to request a report of the current status of all guest rooms. The Attendant Console produces one audit containing information on all rooms. The Front Desk Terminal can produce two types of Room Status Audits: Room Occupancy Audits and Room Condition Audits. These audits can be requested by room type,

or for all rooms. See Room Occupancy and Room Condition. Each audit (Console or Front Desk Terminal) also shows the call restriction status of the room and whether there is a maid in the room. See Call Restriction on and Maid in Room Status.

Room Type Audit: This feature allows the Attendant to generate a report of all guest rooms of a particular type, giving their room number, occupancy and whether there is a maid in the room. This report can only be generated from a Front Desk Terminal.

Wakeup Audit: This audit indicates all guest rooms having wakeup calls enabled. The Attendant Console and the Front Desk Terminal generate identical reports.

Wakeup/Room Condition Audit: The system is programmed through CDE to print a report of all guest rooms having wakeup calls enabled, automatically, at a set time each day. At the same time it is programmed to change the occupancy and condition of all Occupied/Clean rooms to Occupied/Dirty.

Hotel/Motel - Audit Screen

The Audit Screen is entered from the House Statistics screen by pressing the Audit softkey. This screen is used to generate various kinds of audits (hard copy reports). Each kind of audit appears as a corresponding softkey.

Hotel/Motel - Wakeups

This feature provides automatic and personal wakeup calls to the guest room. The attendant, sub-attendant, or guest can set up multiple automatic wakeup calls that will ring the guest room at a prearranged time. The attendant or sub-attendant can set up multiple personal wakeup calls that issue a callback to the attendant or the sub-attendant so they can personally provide the wakeup call to the guest.

Multiple (up to 3 in a 24-hour period) personal or automatic wakeups may be set to occur once or daily. Daily, multiple, and personal calls are dependant on the MOSS Option 102 (Feature Level) being enabled to level 1 or greater.

Existing wakeup calls can be modified or canceled. After answering a wakeup call, the extension user receives either a special tone, music, or a recorded announcement. A different recorded announcement can be given when the system is in night service.

If the wakeup call is not answered within six rings, or if the extension is busy, an attempt is made to ring the extension two more times at 5 minute intervals. Each wakeup attempt can generate a single line report on a system printer. If the call is still unanswered, the wakeup is canceled and the attendant can be notified that the wakeup was not honored. Wakeup calls to a SUPERSET 4150 or SUPERSET 430 telephone are treated as a timed reminder ringing the set once and setting a reminder prompt. A wakeup attempt on a SUPERSET display telephone does not generate a single line report. The Attendant can print a list of all of the current Wakeup requests.

Hotel/Motel - Call Blocking

Call Blocking allows the attendant or subattendant to inhibit room-to-room calls. Users of an attendant console, or SUPERSET 430 and SUPERSET 4150 telephones programmed as subattendants, can activate or deactivate this feature. Calls to the attendant, subattendant, or to extensions without the Call Blocking COS option selected may be made as usual. The system treats attempted calls between restricted extensions as illegal numbers and gives the calling party reorder tone. Alternatively, Call Rerouting can be used to intercept blocked calls to an appropriate destination such as the Attendant Console. See Call Rerouting.

Hotel/Motel - Call Restriction

The Call Restriction feature is used to give each guest room a level of calling privilege. The three levels are

- Internal
- Local
- Long Distance.

The Attendant can assign any of the levels to a particular room. In addition, the system automatically sets the call restriction for a room to a programmable value when an occupancy change to either vacant or occupied occurs. On the Front Desk terminal screen, this is called Call Privilege.

Hotel/Motel - Check Out

The Check Out softkey provides a simple, fast checkout procedure. If the occupancy setting of the guest room is set to Occupied, one keystroke will

- Change the room occupancy field to Vacant
- Set the room condition to Dirty
- Erase the Guest Name
- Turn off Do Not Disturb and Wakeup (if set)
- Clear message registers
- Apply predefined Call Restrictions to the room telephone.

This feature is available with the Front Desk Terminal.

Hotel/Motel - CLASS (station side) for Analog Telephones

Refer to the feature CLASS for Analog Telephones, page 141.

Hotel/Motel - Do Not Disturb (DND)

The Do Not Disturb feature blocks calls from ringing at a guest's telephone. Outgoing calls are not affected. The Attendant can set or clear Do Not Disturb for a guest room telephone, whether or not the attendant is connected to the guest room phone. A guest can also set and clear Do Not Disturb from a guest room phone. See Do Not Disturb.

Hotel/Motel - Front Desk Features

The Front Desk features are all accessed through the House Statistics Screen on the Front Desk Terminal (VT100). This screen appears on start up and contains the current status of the guest rooms as well as the time of the last status update. Four additional screens can be accessed via the House Statistics screen.

Hotel/Motel - Guest Names

The Front Desk Terminal can enter and store Guest Names in two data fields. The last name field accepts up to 15 alphanumeric characters. The first name field accepts up to 6 characters. They are displayed in uppercase (even if they are entered in lower case), with last name first. The SUPERSET 4150 or SUPERSET 430 telephone can enter and display one 10-character name, or can display up to 10 characters of a name entered from a Front Desk Terminal.

Guest names can be displayed on an Attendants Console if entered from the Front desk Terminal or a SUPERSET 4150 or SUPERSET 430 telephone, but they cannot be entered or searched for. This feature is only available with Front Desk features and SUPERSET 4150 or SUPERSET 430 telephones.

Hotel/Motel - Guest Room Message Retrieval

A message waiting indication set by the Attendant can be

- A flashing lamp on the telephone.
- A distinctive ringing pattern every 20 minutes. The telephone rings with this distinctive ringing pattern if the extension has been busy, or has Do Not Disturb set, or until message waiting is canceled.
- A message on the display of a SUPERSET 4150 or SUPERSET 430 telephone (if used as a guest room telephone).

The Cancel softkey on a display SUPERSET telephone can cancel Message Waiting. Otherwise a guest cannot cancel the Message Waiting indication from the hotel room. It must be canceled by the Attendant. See Message Lamp Test.

Hotel/Motel - Guest Room SUPERSET Key Programming

A block of guest room SUPERSET telephones can be programmed with Speed Dial and Feature Access keys. This can only be done through CDE. It is possible to program up to three separate blocks of telephones with unique speed dial and feature access keys.

Hotel/Motel - Guest Room Update Screen

This screen is accessed through the Room Update softkey and it greatly simplifies the guest check in and check out procedure. From this screen Guest Name, Room Occupancy Status, Room Condition, and Call Privilege can be entered or changed; Wakeup time, Message Waiting and Do Not Disturb can be set or cleared; and the Message Register can be cleared. A simple method of checking out a guest is provided via a softkey that is accessed through the Occupancy field. See Check Out.

Hotel/Motel - Guest Search Screen

The screen is accessed via the Guest Search softkey on the House Statistics Screen. This search facility allows searching by last name. A partial or complete text string can also be entered. All names matching the input string are displayed. See Guest Names.

Hotel/Motel - House Statistics Screen

The House Statistics Screen displays the following summaries.

- **Guest Room Occupancy Summary:** Vacant, Occupied, Reserved, and Guaranteed.
- **Room Conditions Summary:** Clean, To be cleaned, To be inspected, Not in service, and Maid present.
- **Feature Usage Summary:** Do Not Disturb on, Wakeup set, Message Waiting on, Non Zero Message Registers, and Call Blocking.

Six softkeys gives access to other modes of operation:

- Audits
- Guest Search
- Quit
- Refresh (used to recalculate totals)
- Room Search
- Room Update.

Hotel/Motel - Internal Number Block

Provides room number confidentiality in Hotels. The hotel operator has the choice of displaying the room number on the telephone display for Guest to Guest calls. See Internal Number Block, page 170.

Hotel/Motel - Maid in Room Status Display - SUPERSET Display Telephones

This feature allows an authorized SUPERSET display telephone to determine which guest rooms have maids in them.

Hotel/Motel - Message Lamp Test

The Message Waiting Lamp on a guest room telephone is tested automatically whenever the room status changes from occupied to vacant and there is no message waiting. It runs whether the change was made from a Front Desk Terminal or from an Attendants Console. However there is no indication at the Front Desk Terminal that it has run. If there is a failure, notification is through the alarm icon at the Console. The test verifies lamp operation and confirms that the telephone is still connected in the room. The test does not verify bell operation.

Hotel/Motel - Message Register

The Message Register tracks the number of completed external calls or call units for each extension. There are two modes of operation. The first counts the number of external calls made by each room. The second keeps track of meter pulses being sent from the far end to the associated trunk circuit. These pulses can be used to determine the amount charged against the guestroom making the call.

The Attendant Console displays the current value of the message register for a room each time a room number is entered. The message register can be cleared by the Attendant from the Console or automatically upon requesting an audit. Clearing the message register can be recorded on a system printout. Meter pulses are recorded in SMDR. See Station Message Detail Recording (SMDR).

Hotel/Motel - Multi-user

Four front desk terminals can run the Hotel/Motel application at the same time. However, two terminals cannot edit information for the same room at the same time. The Front Desk Terminal also checks that the room is not being accessed by an Attendant Console. If it is, the message "Room being accessed by another user. Try again later." appears on the screen. Guest names can be entered, changed or deleted from the Front Desk Terminal or a SUPERSET display telephone. The entry that is done last is the one stored.

Up to 11 consoles can be configured on one system. Two (or more) consoles can access a guest room at the same time. The user that leaves the guest room update last updates the database last, and that information is the valid data for the room. If two users are changing different fields at the same time, all the information should be captured, since only fields that have been modified will be updated when the Exit softkey is pressed.

Hotel/Motel - Passwords

Entering or changing guest room information from the Front Desk can be controlled by passwords. The user of an attendant password can read information about rooms, request audits, and conduct searches. The user of a supervisor password can, in addition, enter and change information about a guest room, since this password presents the Guest Room softkey.

Hotel/Motel - Property Management System (PMS)

The SX-200 EL and SX-200 ML systems can interface to a Property Management System (PMS) to provide integration of system and PMS functions. A PMS provides a computerized method of controlling and monitoring hotel/motel functions. The system interfaces to personal computers with the Lodgistix PMS software package (or a package that follows the same protocol). Hotel/Motel information is stored in the system and in the PMS. The information is split between the PMS and the system as follows:

SYSTEM DATABASE	PMS DATABASE
Message Register	Message Register
Message Waiting	Message Waiting
Do Not Disturb	Room Status
Automatic Wakeup	Automatic Wakeup
Guest Name	Guest Name

The PMS Room Status feature and the Console or Front Desk Terminal Room status are mutually exclusive. See Room Status Display. The PMS interface maintains the following information between the system and the PMS:

- Automatic Wakeup
- Check in/out
- Guest name
- Maid in room status
- Message registration of outgoing trunk calls
- Message waiting
- Confirm wakeup by offhook.

Automatic Wakeup: This feature allows the Attendant to enable or disable an automatic wakeup on a room phone from a PMS terminal.

Check in/out: When a guest checks in (PMS Check In), the room telephone is enabled to allow outgoing trunk calls. The attendant may restrict the room phone to internal calls, local calls, or long distance calls using the Outgoing Call Restriction feature described in the Attendant Console Guide. Upon check out (PMS Check Out), the phone is disabled from making calls and the PMS clears Message Register, Message Waiting, Do Not Disturb, and Wakeups from the guest room database.

Guest name: This feature allows the name of a guest to be associated with a room in the PMS. It is sent to the system, when a guest checks in, and is stored against the room extension.

Maid in room status: This feature allows the maid to change the room status (clean/dirty) from the room telephone. The Maid in room status is also indicated on the PMS terminal. This feature is functionally identical to that of the attendant room status, however the displaying and monitoring of room status is completely controlled from the PMS terminal.

Message registration of outgoing trunk calls: This feature provides the PMS with the number of trunk calls made from a room (local and long distance). A call-accounting device connected to the system monitors SMDR reports for long distance calls. The charge for these calls is automatically added to the guest's bill at check out time. Call-costing equipment may be attached to the PMS to allow the PMS to handle call costing.

Message waiting: This feature allows the Attendant to enable or disable the Message Waiting Lamp on a room phone from a PMS terminal.

Confirm Wakeup by Offhook: This feature allows users of SUPERSET display telephones to acknowledge a wakeup by going offhook, instead of having to read the message and press a softkey.

Hotel/Motel - Room Condition

This feature indicates the current housekeeping condition of a guest room: Clean, Dirty, Out of service, or To be inspected. It can be set from the Attendant Console or the Front Desk Terminal. Some conditions can be set from the guest room telephone. For more information see Room Status Display and Maid in Room Status Display on. Room Condition can be displayed as part of the Room Status display on the SUPERSET display telephone.

Hotel/Motel - Room Occupancy

This feature indicates the current occupancy of a guest room. It can be set from the Attendant Console or the Front Desk Terminal. The four types of Room Occupancy are: Vacant, Occupied, Reserved, or Guaranteed. See Room Status Display.

Hotel/Motel - Room Search Screen

The Room Search Screen is accessed through the Room Search softkey. Room searches are based on Room Type, Room Number, and Room Status. Any search other than Room Type or Room Number requires that a room code (a COS name) be entered to specify the type of room, such as single room, that should be searched. Nine types of room searches are available:

- Dirty
- Guaranteed
- Maid in Room
- Reserved
- Room Number
- Room Type
- Service
- Vac
- Vac/Clean.

Hotel/Motel - Room Status Display

This feature allows the Attendant to display and change the status of one or more rooms. Room status is made up of: Room Occupancy, Room Condition, Telephone Privileges (call restrictions) and Maid in Room. Each (except Maid in Room) can be set independently of the other by the Attendant. The choice of settings for room occupancy and room condition are:

Occupancy	Condition
Vacant	Clean
Occupied	Dirty
Reserved	Out of Service
Guaranteed	To Be Inspected

The system can be programmed to change the status of all “occupied/clean” rooms to “occupied/dirty” at a predetermined time. At the same time the system generates a list of all Auto Wakeup requests.

Room Status is displayed on an attendant console, a front desk terminal, or a SUPERSET display telephone.

Attendant Console: Selecting a room number on the console displays the status from the above list. The maid in room status, the current call restriction status and the current message register count are displayed at the same time. The console can also display all rooms that have the following status combinations:

- A maid is in the room
- The room is vacant and clean
- The room is reserved and clean
- The room is out of service.

Front Desk Terminal: Room status for a particular room is displayed on the Guest Room update screen. Occupancy, condition, call privilege, and maid in room are displayed as separate fields. Room status for a number of rooms can be displayed by doing a room search on the basis of

- A maid is in the room
- The room is vacant and clean
- The room is vacant
- The room is dirty
- The room is reserved
- The room is out of service
- The room is guaranteed.

SUPERSET Display Telephone: This feature allows an authorized SUPERSET display telephone to display the status of guest rooms. The room occupancy parameters are

- Vacant, occupied, reserved, guaranteed.

Each of these sections is further divided by room condition:

- Clean, dirty, out of service, to be inspected.

Maid in Room is displayed separately as part of the Maid in Room feature. Call restriction is not displayed.

Hotel/Motel - Room Types and Room Codes

With this feature hotel guest rooms can be divided into 50 different types, such as single, double, queen, smoking, and nonsmoking. This is done through customer data entry (CDE) programming by putting each room type in a separate Class of Service (COS). Since each COS can have a different name associated with it, the room is identified by the COS name. By default, it can be identified by the code (COS number) associated with the COS name. Searches and audits can be requested by room type or code.

Since the Front Desk has an alphanumeric keyboard, the COS name can be alphabetic. When an alphabetic name is entered on the Front Desk Terminal, it can be displayed on the Attendant Console.

Hotel/Motel - Single Line Reports

Single Line Reports are types of audits used to record changes in status for individual rooms. These reports are generated automatically, and provide hard-copy evidence that a change has occurred. The printouts produced by Single Line Reports are limited to 40 characters in length and start with the room extension number, date and time. There are three categories of single line reports:

- Wakeups
- Message Registration
- Message Waiting.

Hotel/Motel - Suite Services

Suite Services associates multiple telephones with one another in a hotel suite for basic call handling, call privileges, SMDR, room check-in and check-out, Caller ID, messaging, and call forwarding.

Hunt Groups

Hunt Groups, or master number hunting, allows a collection of devices to share a common access code. A caller can be routed to or dial the access code, and have the call completed to an available extension in that hunt group. Extensions within a hunt group may still be accessed directly by dialing the extension number. Some special types of hunt groups include

- Recording Hunt Group. See RAD Support.

- UCD Agent Hunt Group. See Uniform Call Distribution.
- Automated Attendant Hunt Group. See Automated Attendant.
- Voice Mail Hunt Group. See Voice Mail Support.

Two types of hunting are provided by the system, circular and terminal:

- Circular Hunting starts at the extension after the last extension in the hunt group at which a call was completed (the extension rung), and hunts overall extensions in the hunt group in the sequence programmed. Hunting stops at the first idle extension found.
- Terminal Hunting starts at the first extension in the hunt group and terminates at the first idle extension found. Hunting takes place in the order in which the extensions were programmed into the hunt group.

Illegal Access Intercept

Calls to restricted access codes or extension numbers can be routed to an answering point for completion. The illegal access intercept point can be an LDN position on the attendant console or any valid reroute point. Illegal number intercept points can be programmed to be different for DAY, NIGHT1, and NIGHT2 operation.

Inhibit Trunk Ring-Me-Back During Dialing

This feature inhibits the operation of a particular instance of the station transfer security feature. If an industry-standard telephone is dialing and goes on-hook while a trunk is on consultation hold, that trunk does not recall the station and is instead dropped. This prevents a trunk from locking when the flash on the trunk was intended as a hangup and the station user did not expect a trunk to be on consultation hold.

Intercept To Recorded Announcement

Incoming trunk calls can be intercepted to groups of recording devices after dialing vacant numbers, reaching busy extensions, getting no answer, or as required.

Internal Number Block

Blocks the number of the station/set on the display of SUPERSET 4000 telephone sets, SUPERSET 400 telephone sets, and ONS/CLASS stations telephones on the same system.

Inward Restriction (DID)

An extension can be barred from receiving calls directly from DID trunks.

Language Change

This feature allows SUPERSET display telephones to display text and softkey prompts in a different language.

Last Number Redial

This feature allows the Attendant Console and any telephone user to redial the last manually dialed internal or external number with a single key operation.

Last Party Receives Dial Tone

This feature allows the last party left on a call, after the other party(s) hang up, to receive dial tone and be able to dial. Normally, this party would receive silence and after 30 seconds be locked out.

Line Lockout

The system locks out an extension if the extension goes off-hook and does not dial digits or go back on-hook for a length of time. Lockout also occurs if the extension does not hang up at the end of a call. In the locked-out state, the extension cannot originate or receive calls, and appears busy to potential callers.

Line Preference

The Line Preference feature allows the system to automatically select which line is used when the set goes Off-hook to originate a call. One of the following may be selected:

- Prime key
- CO Line Key
- CO Line Group Key
- Personal O/G Key
- Manual (user must press a line key to originate a call).

The user may override the line preference by pressing another line key prior to going Off-hook for a call origination. This feature has no effect on the answering of calls.

Line Privacy

This feature ensures that, if desired, conversations on Key, Direct Trunk Select, CO Line, and Private Trunk Lines are private. When such a line is in use at one set, other appearances of the line cannot join the conversation.

Line Selection

SUPERSET telephones are equipped to have many line appearances programmed on them. When the user starts dialing, the system selects a line (if programmed to do this). When the set is ringing and the user goes off hook, the system selects the line to answer. The user can also select a specific line to make or answer a call.

Line Types and Appearances for SUPERSET Telephones

SUPERSET telephones are equipped with keys that can be used as Line Select Keys. These lines can provide additional calling capability, direct access to calls appearing at other sets, and direct access to trunks. There are seven types of lines:

- Prime Line
- Key Line
- Multicall Line
- Direct Trunk Select Line
- Private Line
- Personal Outgoing Line
- BLF/DSS Line.

Some line types can appear on only one SUPERSET telephone. Other line types can appear on more than one telephone. Because the same line may appear on up to a maximum of 32 other sets, the telephone and the lines are not always busy at the same time. One or more lines may be in use but the telephone is idle and available for a call.

Prime Line: The SX-200 EL and SX-200 ML system identifies each SUPERSET telephone by an extension number known as the Prime Line. The Prime Line is always a Both-Way and Immediate-Ring Line. A Prime Line can be changed to operate as a Multicall or Key Line by giving the line an appearance at another set. If an appearance of a Prime Line is programmed at other sets as a Multicall Line, the Prime Line operates as a Multicall Line. If an appearance of a Prime Line is programmed at other sets as a Key Line, the Prime Line operates as a Key Line.

Key Line: A Key Line is an appearance of one extension number on two or more telephones. This extension number can be for another SUPERSET telephone or an industry-standard telephone. If the line is in use at one set, the other appearances of the line are busy and unavailable.

- There can be only one appearance of any one Key Line on a SUPERSET telephone.
- Call Direction and Ring Variants can be programmed independently for each appearance.

Multicall Line: A Multicall Line is an appearance of one extension number on two or more telephones. This extension number can be for another SUPERSET telephone or an industry-standard telephone. When one appearance of a Multicall Line is in use, the other appearances are still available to make or answer calls.

- Call Direction, Ring and Secretarial Variants can be programmed independently for each appearance.
- There can be up to 31 appearances of any one Multicall Line on a given SUPERSET telephone.

Direct Trunk Select (DTS) Line: A DTS Line operates like a Key Line, but it directly accesses a specified dedicated CO trunk. It can be used for incoming and outgoing calls. For further

information see Direct Trunk Select. The DTS trunk can appear on up to 32 SUPERSET telephones.

- There can be only one appearance of any one Direct Trunk Select Line on a SUPERSET telephone.
- Direction and Ring Variants can be programmed independently for each appearance. The direction variant allows control of the type of trunk call, incoming or outgoing or both.
- The user can transfer calls on this line to other extensions.
- DTS outgoing calls bypass ARS.
- DTS calls use the SMDR feature if enabled.

Private Line: A Private Line accesses a dedicated CO trunk directly. As operating TELCOs often provide a less expensive rate for trunks connected to private trunk lines SUPERSET telephones accommodate this type of operation. The user can transfer established calls on this line only to other SUPERSET telephones that have an appearance of the line, using privacy release.

- Personal Outgoing Line

This line is an outgoing-only line that allows the user to make an outgoing call without making the set busy to incoming calls.

- A Personal Outgoing Line has no extension number associated with it.
- There can only be one Personal Outgoing Line per SUPERSET telephone.

BLF/DSS Line: This line type is used by two distinct features; Busy Lamp Field (BLF), and optionally Direct Station Select (DSS). A BLF is an appearance of a station, SUPERSET, logical line or trunk. The LED indicator indicates the state of the BLF appearance (Idle, Busy, DND). A DSS key is a BLF appearance (of a station, SUPERSET, or logical line), associated with the key.

- A DSS key cannot be associated with a trunk BLF appearance.

Line Appearance Variants

Through CDE, the seven line types can be programmed to control call direction and ringing. Multicall Lines can also be programmed as Secretarial Lines.

Direction: Direction can restrict calling for an appearance of a line to Both-Way, Incoming-Only, or Outgoing-Only. The outgoing direction for a line on a set is only available if the line is programmed for No Ring. If programmed for Delayed Ring or Immediate Ring the line must be either Both Way or Incoming Only.

Ring: The ring option determines whether new calls to a SUPERSET telephone line appearance ring immediately, ring after a delay or not ring at all.

Secretarial: The secretarial feature interacts with the Do Not Disturb feature for improved call handling. See Secretarial Line.

Lockout Alarm

The system locks out any set that remains off-hook and not connected to another set or trunk for more than 45 seconds.

The Lockout Alarm Feature

- Generates an audible alarm through the console
- Activates the alarm relays
- Displays the location of the locked out device.

When a set is locked out, if Lockout Alarm is enabled, all consoles warble with a long-short-long cadence. This cadence overrides other cadences that might be active. The attendant can display the time and date the lockout alarm occurred, the extension number of the device, and a message stating that the device has been off-hook too long.

Logical Lines

A Logical Line is a line on a SUPERSET telephone that is not an appearance of any station or other SUPERSET telephone. Each Logical Line has its own extension number and can exist on up to 32 different SUPERSET telephones. Logical Line extension numbers can be used in many places where station or SUPERSET telephone lines can be programmed such as Call Rerouting.

Maintenance

The SX-200 EL/ML system provides extensive maintenance coverage. All types of peripheral hardware are periodically tested automatically by the system. Maintenance users may also test individual circuits on demand. The system also maintains a fault/event history log (maintenance log).

Manual Line (Dial 0 Hotline)

When a Manual Line extension goes off-hook it is routed directly to the extension's dial 0 routing point. The extension can still receive calls.

Messaging - Advisory

This feature allows a SUPERSET display user to provide a short message to be displayed on any SUPERSET display telephone or attendant console that calls the set. The message replaces the time and date display on the sets where it is activated. The system provides 15 system-wide messages.

Messaging - Call Me Back

A set user calling a busy or unanswered set can leave a message for the party to return the call. The message waiting indication can be

- A flashing lamp on the set at 0.5 seconds on, 3.5 seconds off (if equipped)
- An indication on the set's display (if equipped)>
- Ringing at the set with a distinctive ringing pattern.

The Message Waiting indication continues until the set user reads the message. Messages can be read when the set is idle or during a call. On SUPERSET display telephones, the display shows the time of the call, and the caller's extension number and name (if programmed). Optionally, the system can be programmed to record each occurrence of Message Waiting on the system printer when the message is sent from the Console, the Front Desk Terminal or PMS.

Meter Pulse Collection

Meter Pulses are often used to calculate the cost of outgoing trunk calls, thus allowing the call to be charged back to the originator. The system can be set up to detect and collect certain types of Meter Pulses sent to a trunk circuit during outgoing calls. These are then recorded in the trunk's SMDR reports. Types of Meter Pulses which can be detected by the system without additional hardware include

- Tip-Ring reversals
- XT lead signaling (Analog CO Trunk)
- M&MM lead signaling (Digital LS/GS Trunk).

Other types of Meter Pulses common in the telephone industry include 50 Hz, 12 kHz, and 16 kHz type pulses. Detection of these types requires the addition of an external interface which converts these pulses to a ground signal which is then applied to the XT Lead for the Analog CO Trunks, or to the M or MM lead for the Digital LS/GS trunks. (For Digital LS/GS trunks, -48 Vdc must be applied to the other lead so that when the ground is applied to the M or MM lead, current flows through the circuit and gets detected as a pulse.)

This feature is associated with the Message Registration feature. See Property Management System for additional information.

MILINK Data Module

The MILINK data module is a limited distance, asynchronous, digital dataset that converts the data signals of RS-232 serial devices to high-speed digital signals. It allows an RS-232 device, such as a computer or display terminal, to be connected to the system through a SUPERSET 410, SUPERSET 420, or SUPERSET 430 telephone. The 2-pair cable that connects the SUPERSET telephone to the switch carries both voice and data signals, allowing a user to use the RS-232 device and the SUPERSET telephone simultaneously.

The MILINK data module is positioned beside or under the user's SUPERSET 410, SUPERSET 420, or SUPERSET 430 telephone, and connects to a modular jack located on the base of the telephone. The RS-232 device connects to a DB-25 pin connector on the MILINK data module. A 9 Vac wall-mount power supply provides power to the MILINK data module.

MITEL Application Interface (MAI)

The MITEL Application Interface (MAI) software package allows MITEL computer-based applications to access the system features. MAI is used in conjunction with an external host computer connected via an RS-232 link to a DATASET 2100 device. The DATASET device is connected to a DNIC port on the system via a single twisted pair.

MITEL Network Gateway

The MITEL Network Gateway provides SX-200 systems with Primary Rate Access (PRA) to the ISDN service provider. By interfacing the SX-200 switch with the ISDN service provider, it allows SX-200 users to access ISDN services, such as Direct Dial In (DDI), Calling Line Identification (CLID), and Call By Call Service Selection (CBC).

You must purchase ISDN services from the ISDN service provider. In addition, you must purchase software options from Mitel Networks Corporation that are related to the desired ISDN services. You install these software options on the Network Gateway to permit the ISDN service provider service to interface with the SX-200 system.

The cabinet that holds the MITEL Network Gateway hardware is similar in construction to a Personal Computer (PC) tower cabinet. The Network Gateway consists of an IBM-compatible motherboard with one Application Fiber Controller (AFC) card and up to four Primary Rate Interface (PRI) cards. The AFC card connects to a Fiber Interface Module (FIM) on the SX-200 system via fiber optic cable; the PRI cards interface to the ISDN service provider over one or two T1 trunks. To the SX-200 system, the AFC card appears like a T1 card in a peripheral node running T1/D4 protocol; to the ISDN service provider, the PRI card simulates an ISDN switch. In simple terms, the Network Gateway accepts call request, progress, and termination messages from the SX-200 system and converts them into ISDN messages for the network and vice-versa.

The Network Gateway supports the following ISDN network services:

- Calling Line Identification (CLID) - If this service is purchased from the ISDN service provider, the ISDN network presents the telephone number of the calling party to the Network Gateway.
- Calling Line Identification Restriction (CLIR) - This feature allows users to prevent their telephone number from being presented to the called party.
- Direct Dial-In (DDI) - If this service is purchased from the ISDN service provider, the ISDN network presents the dialed number of incoming calls to the Network Gateway.
- Call-By-Call Service Selection (CBC) - This feature allows telephone users to select the ISDN network services that they wish to use on a per call basis.

The ISDN Network Gateway interfaces the following SX-200 peripheral devices with the ISDN network:

- Attendant consoles
- SUPERSET telephone sets
- Industry-standard telephone sets.

Moving Stations and SUPERSET Telephones

This feature allows extensions to be moved easily from one circuit to another. Previous programming for the extension, such as name, COR, and COS, is preserved and moved with it.

Multi-Attendant Positions

The system can handle multiple attendant consoles, giving unique hold slots to each attendant. Incoming trunk calls can be programmed to appear at all consoles, or specific console(s). Similarly, Extension Dial 0 calls, Priority Dial 0 calls, Intercept To Attendant calls, can be programmed to appear at all consoles, or at a specific console(s).

Any console in a particular tenant group can switch that tenant group to Night Service or to Day Service. See Attendant Night/Day Switching. Also see Recall, and Attendant Console LDN Keys, Attendant Transparent Multi-Console Operation and Tenanting.

Music-on-Hold (MOH)

A customer-provided music source can be connected to the system via a Music-on-Hold/Pager Module on the Universal card or on the Music-on-Hold/Pager Module via a DNIC port. Music-on-Hold can be used with Campon, Hold, Universal Call Distribution (UCD), ACD, and other features.

Each tenant of the system can also have its own Music-on-Hold source through a DMP unit that is connected to a DNIC port. Each DMP unit is accessed by a directory number programmed in its tenant group. Up to 76 Music-On-Hold sources can be programmed (75, for the 25 tenants in Day, Night 1 and Night 2 service, and the system source).

Use of the Music-on-Hold feature may require, under applicable copyright or other provincial, local, state and/or federal rules, regulations and/or statutes, that you obtain a licence from the local performing rights society or copyright owner before you can provide music on hold to telephone users. Contact your music supplier for more information.

Music from an ONS Source

A customer-provided ONS music source can be connected to the system via an ONS port, which provides a cost-saving alternative to music from DMP and Music-on-Hold/Pager sources. Music from an ONS Source can be used with Campon, Hold, Universal Call Distribution (UCD), ACD, and other features. This feature also supports system tenants. Use of the Music from an ONS Source feature may require, under applicable copyright or other provincial, local, state and/or federal rules, regulations and/or statutes, that you obtain a licence from the local performing rights society or copyright owner before you can provide music on hold to telephone users. Contact your music supplier for more information.

Names

The system programmer can assign names to Extensions, Classes of Service, Tenants, Trunks, Trunk Groups, ACD Paths, ACD Positions, ACD Agent Groups, and Hunt Groups. A user of a SUPERSET display telephone can program their name from their telephone.

Never a Consultee

The Never a Consultee feature protects an extension from being dialed or retrieved by extensions that have a Consultation Hold in progress.

Never a Forwarder

The Never a Forwarder feature prevents an extension or console from having any calls forwarded to it by another extension. Extensions are prevented from setting up forwarding to extensions or consoles with the feature enabled.

New Call Ring

When a SUPERSET telephone is busy, and a new call attempts to ring the set, a single burst of ringing will alert the user that another call is waiting.

NI3 Calling Name Delivery

The NI3 Calling Name Delivery feature allows the called party to see the name of the caller on the display screen of the telephone on incoming calls. The NI3 protocol also allows a link between calling name and calling number for outgoing calls. The caller can set the calling party number presentation indicator to "Allowed", and the calling name stored at the Central Office will be displayed with the calling number. The presentation of calling number and calling name can be allowed or prohibited through IMAT programming.

Night Bells

The Night Bell feature allows incoming and internal calls to be directed to common alerting devices. The call can be answered from the Attendant Console or from an extension with TAFAS Access. See Trunk Answer From Any Station (TAFAS).

The extension number assigned to the Night Bell can be used as an answer point or alternate answer point for most features in the system. The system provides a contact closure which operates the alerting device. Night Bells are activated by relays on a Universal Card receiver/relay module or on the Music-on-Hold/Pager Module via a DNIC port.

Night/Day Switching

A SUPERSET display telephone can put the system (or particular tenant group or groups) into DAY Service or one of two Night Service modes, NIGHT1 or NIGHT2. In Night Service the telephones display NIGHT1 Service or NIGHT2 Service as appropriate. Also see Night Services, Attendant Night/Day Switching, and Tenanting.

Night Services

The system has three different service modes: DAY, NIGHT1, or NIGHT2. When the system or tenant group is in Night-Service mode, incoming trunk calls and calls to the Attendant can be rerouted to specified extensions or activate common alerting devices (Night Bells).

Night Services Flexibility

This option allows the Attendant to change the Night Service assignment of non-dial-in trunks. The system allows full flexibility of trunk assignment.

Node Identification

The Node Identification feature works with the Analog Networking feature to provide consistent dialing of extension numbers throughout a network of SX-200 PBXs. For any extension, the Node Identification digits plus the extension number uniquely identifies the extension from all others on the network. The extension can be reached by dialing the same string of digits from any node in the network. For the use of the node identification code in Analog Networking, see Analog Networking.

Non-Busy Extension

An extension with the Non-Busy Extension feature enabled can have a maximum of 5 parties connected and never appears busy to the system. If a new call is directed to a non busy extension that is already in a call, the system automatically overrides the existing call. After a warning tone, the new caller joins the conversation.

Numbering Plan Flexibility (Conflict Dialing)

The numbering plan used within the system is completely flexible. The system can be programmed through CDE with any combination of 1-, 2-, 3-, 4-, and 5-digit numbers. Also see Conflict Dialing.

Off-Hook Alarm to Display Sets

This feature notifies a user of a display set that a set user has put the handset offhook.

Off-Hook Voice Announce

Allows a party to place a directed page to a busy SUPERSET 4025, SUPERSET 4125, or SUPERSET 4150 display telephone that is not in handsfree mode. The announcement is heard through the speaker, only by the paged party.

Off Premises Extension (OPS)

Industry-standard telephones not in the immediate vicinity of the system can be directly connected to the system without the use of special trunks using a six-circuit OPS (Off Premises) Line Card.

Originate Only Extension

This feature allows an extension or dataset to originate calls. The extension can only receive calls that are forwarded from another extension. The system treats calls dialed to Originate Only Extensions as illegal numbers.

Overlap Outpulsing

Overlap Outpulsing occurs when the system begins dialing on a trunk before the user has dialed all digits in the destination's telephone number. By default, the ARS package outpulses digits as soon as the trunk seizure is acknowledged. This provides a shorter total dialing time, especially on non-DTMF trunks. This feature can be turned off, forcing the ARS package to collect all dialed digits before outpulsing the resulting digit string on the outgoing trunk.

Override (Intrude)

This feature allows a user who encounters a busy extension to enter the conversation. Before override voice contact is established, the overriding party and both parties in the original conversation receive a warning tone. The tone is repeated at regular intervals while the overriding party is connected to the existing call. Display SUPERSET telephones display the name and/or extension number of the overriding party.

ONS Positive Disconnect

ONS Positive Disconnect forces an ONS device to go on-hook when the far-end disconnects. A momentary electrical break on the ONS device forces the disconnection. Some FAX machines or answering machines require this electrical break to recognize that the other party has terminated the call.

ONS Ring Groups

The ONS Ring Groups feature provides the ability of multiple ONS telephones to ring when a master telephone is called. Each ONS telephone in the ring group still has its own extension number, therefore allowing the ONS telephone user to accept calls intended for that telephone plus answer calls directed to the master telephone. Each user can also answer his/her own calls and have his/her own voicemail.

Override Security

The Override Security option provides an extension, DISA trunk, or dial-in tie trunk with security against Override. See Attendant Busy Override and Override (Intrude) on.

Paging - PA

Paging equipment can be connected to the SX-200 EL or SX-200 ML system via a Paging/Music-on-Hold module on the Universal Card or on the DNIC Music-on-Hold/Pager Unit (DMP) via a DNIC port. Up to nine paging zones, with separate or simultaneous access, can be provided. An extension, tie trunk, or DISA trunk can access the paging equipment by dialing the required access code. Access may be restricted to any of the nine zones depending upon the access code dialed. If an extension tries to access busy paging equipment, Busy Tone is returned. See Attendant Paging Access. Also see Paging - PA and Telephones.

Paging -Telephones

There are three different types of paging that page telephones (see Paging - PA for PA Paging - based on a Pager and paging zones, and see Paging - PA and Telephones for the combination of overhead paging and telephone paging)

- Directed Page - pages one user via his/her telephone speaker
- Group Page (and Meet Me Answer) - pages members of a defined group via their telephone speakers
- All Set Page - pages all members via their telephone speakers.

Both the paging party and the paged party receive a single burst of tone to indicate that a page is about to occur. As well, only idle telephones may be paged via Directed Page or Group Page.

Directed Page: Allows a party to page a specific telephone set via its telephone speaker. The connection is one-way audio, and is terminated when the paging party hangs up. Another party attempting to call a set that is being paged in this manner will receive busy tone. The paged party can answer the page as if it were a normal incoming call to the Prime key.

Group Page: Allows a party to page all telephones in a paging group simultaneously via their telephone speakers. The connection(s) are one-way audio to each telephone in the page group, and are terminated when the paging party hangs up. A telephone being paged in this manner may originate and receive calls. When this occurs, the paging on that telephone is terminated.

Meet Me Answer: Allows a party to respond to a group page. It does not apply to Directed Page. A paged party may respond in this manner if the paging party and the paged party are in the same page group. If a party is involved in a call, but hears the page from another telephone, they may put the current call on hold, and respond to the page. The paged party must respond to the group page within 15 minutes - after this, the system cancels the page.

A paged party should not try to respond after another group page has been made to another party. If the paging party has not hung up, a Meet Me Answer response will be connected immediately as a normal 2-way conversation. If the paging party has hung up, the response will be treated like a normal telephone to telephone call. Once connected, the call is treated like a normal call, with all other existing features accessible.

All Set Page: Allows a party to page all telephones simultaneously via their telephone speakers. The connection(s) are one-way audio to each telephone, and are terminated when the paging party hangs up. A telephone being paged in this manner may originate and receive calls. When this occurs, the paging on that telephone is terminated.

Paging - PA and Telephones

This feature enables overhead paging with telephone set paging. The attendant console user or the telephone set user can initiate a page that includes the PA with Group Pages or All Set Pages.

Parallel Connection of Industry-Standard Telephones

A maximum of three industry-standard telephones equipped with bells can be connected (hard-wired) together on one ONS line.

Personal Speed Call

The Personal Speed Call feature allows the user to program and access up to five personal speed call numbers. The telephone user enters the numbers at the telephone. They may then be accessed via an access code, followed by an index number. These personal speed call numbers may only be accessed from the telephone on which they were entered. Note that in addition to this feature, users also have access to the Abbreviated Dial feature - see Abbreviated Dial.

Pickup Groups

Extensions may be programmed as Pickup Groups, permitting users to answer calls to any other extension within their particular group. See Pickup - Local and Directed.

Pickup - Local and Directed

A telephone can be assigned to a pickup group, and can answer any ringing telephone within that group. This is Local Pickup.

Directed Call Pickup allows an extension user to answer any ringing telephone within the system.

PRI Card Support

This feature allows a PRI card to be installed in the system. With the T1/E1 module, the PRI card provides one or two links (24-48 channels) of T1 ISDN connectivity. The PRI card provides the same connectivity as provided on the ISDN Network Gateway.

Printer/Terminal Support

This feature allows the routing of printouts to the system printer port, to any data port, or to the printer port on the SUPERCONSOLE 1000 Attendant Console. If no new port is specified through CDE, printouts default to the system printer port. All printer ports are RS-232C interface. Printout types include

- Traffic measurement
- SMDR (Trunk, Data, ACD)
- CDE
- Hotel/Motel system printouts
- PMS interface port (must be dedicated)
- ACD reports
- Maintenance logs.

Customer programming printouts may be directed to any or all of seven user defined printers. A maximum of six DNIC-based printer ports can be defined; the remaining port is the system printer port.

Priority Dial 0

The Priority Dial 0 feature can be used to provide an alternate dial 0 routing for extensions in the system. Priority Dial 0 and Dial 0 have separate DAY/NIGHT routing points.

Privacy Enable/Privacy Release

A multi-line SUPERSET telephone may have appearances of Key, Direct Trunk Select, CO Line, and Private Trunk lines that are shared with other sets. When privacy is enabled, while a conversation is in progress, other sets with an appearance of the same line are denied access. The user of the line can, however, use the Privacy Release feature to allow the other sets to join the conversation. See Line Privacy.

If the customer wishes to have their calls public to begin with (privacy released at the beginning of a call), the COS option "Privacy Released at Start of Call" may be enabled. To obtain privacy, the user then presses a Make Private softkey or a Privacy Release feature key.

Programmable Key Module (PKM)

A Programmable Key Module provides a set with additional personal keys. There are two models available:

- Mitel Networks Programmable Key Module 48 (PKM 48) for SUPERSET 4025, SUPERSET 4125, and SUPERSET 4150 telephones that are equipped with an interface module (SIM 1 or SIM 2), and for consoles with a DSS/BLF Interface unit
- Mitel Networks Programmable Key Module 12 (PKM 12) for SUPERSET 4025, SUPERSET 4125, and SUPERSET 4150 telephones that are equipped with an interface module (SIM 1 or SIM 2).

Mitel Networks Programmable Key Module 48 (PKM 48) provides SUPERSET 4025, SUPERSET 4125, SUPERSET 4150 telephones, and attendant consoles with 48 additional personal keys. The SUPERSET telephone requires a SIM 1 or SIM 2 in its base to interface to the PKM 48. The attendant console requires a DSS/BLF Interface unit. When an attendant console has a DSS/BLF interface unit associated with it, only busy lamp field/direct trunk select keys can be programmed. When a PKM 48 is associated with a set, the keys can be programmed with the following functions:

- Speed call keys
- Feature keys
- Key line appearances
- Personal outgoing line keys
- Key system appearances
- Multi-call line appearances
- CO line keys
- Busy lamp field/direct station select keys.

Keys are arranged in four vertical rows on the PKM 48. Beside each key is a Line Status Display that indicates the status of the key. Up to two PKM 48 devices can connect to the set.

The flash rates for the Line Status Displays on the PKM 48 are identical to those on the SUPERSET 4025, SUPERSET 4125, and SUPERSET 4150 telephones.

Mitel Networks Programmable Key Module 12 (PKM 12) provides SUPERSET 4025, SUPERSET 4125, SUPERSET 4150 telephones with 12 additional personal keys. The SUPERSET telephone requires a SIM 1 or SIM 2 in its base to interface to the PKM 12. The personal keys on the PKM 12 provide the same functionality as the personal keys on a PKM 48. Only one PKM 12 connects to a telephone.

Note: The SUPERSET PKM is no longer available, but is still supported on the discontinued SUPERSET 410, SUPERSET 420, and SUPERSET 430 telephones. This PKM offered 30 additional personal keys. The set can support up to three SUPERSET PKMs.

Q.SIG

Q.SIG allows you to connect PBXs from different vendors together to form a private network. With LIGHTWARE 19 and greater software, ISDN Release 8 or greater, and the Q.SIG MOSS option, the SX-200 EL/ML system can connect with any Q.SIG compatible SX-2000 LIGHT system or any other Q.SIG compatible PBX. The SX-200 system provides end node functionality, that means that the SX-200 system can only connect to one other system in the network. Q.SIG supports incoming calls, incoming Calling Name, Message Waiting Indication, Call Transfer, Call Diversion, Call Offer, and Path Replacement (Partial).

RAD Support

Recorded Announcement Devices (RAD) are supported in the system as recording hunt groups. These special hunt groups have features and restrictions on them that allow efficient use of the recording resources. Recording hunt groups are used in the ACD, UCD, Hotel/Motel Wakeup, Automatic Attendant Overflow, and Automated Attendant features.

For ACD, Attendant Automatic Overflow and Automated Attendant, more than one caller at a time can listen to a recording in the recording hunt group. For UCD and Hotel/Motel Wakeup, only one caller at a time can listen to a recording in the recording hunt group. See Attendant Automatic Overflow, Automated Attendant, and Uniform Call Distribution (UCD). Also see Wakeups.

Recall

The Recall feature ensures that calls do not remain unanswered or on hold for an extended period. Any call that has been extended by a console, or an external call that has been extended by an extension to another party, recalls the console or extension if the call is not answered or remains on hold at the end of a timeout period. Recall also works for outgoing external calls. When a trunk is seized, the calling party becomes the recall point. If the trunk is transferred somewhere in the system, recall is by default to the party that made the call.

Receive Only Extensions

An industry-standard telephone with this class of service (COS) option, can receive calls but cannot originate calls. The industry-standard telephone may, however, originate calls and select features specified in its COS after having received a call, and placed the call on hold by flashing.

Record a Call

Record a Call allows you to record both ends of a two-party conversation (internal or external call) in progress at your set. The recorded conversation is stored in your voice mail mailbox. This feature is a purchasable option.

Remote LAN Access

Remote LAN Access provides LAN access to the wide area network (WAN) for both incoming and outgoing calls through LAN servers (for example, routers, bridges) using Mitel's PRI Gateway interface.

Reminder

This feature allows an extension user to program the telephone to ring at a particular time. This can be used, for example, as an appointment reminder. You may program up to three timers (in a 24-hour period) to occur once or to repeat daily. See Wakeups., page 188

Resale Package

The resale package is a method of offering the system's Automatic Route Selection (ARS) "Least Cost Routing" facilities to external users requiring low cost Long Distance calling, much like the offerings of other Common Carriers. DISA trunks are installed for external access to the system. The external user dials one of the DISA trunks, enters a verified account code, and dials the desired external number. The Direct to ARS feature can be used to route the caller directly to ARS. This feature is a specialized application of the SX-200 EL/ML Automatic Route Selection, Toll Control, and Verified Account Code features.

Ringer Control

Users of a SUPERSET telephone or an attendant console can adjust the volume of the ringing telephone or console.

Ringing - Discriminating

This feature provides two different ringing cadences to allow a user to distinguish between internal incoming calls (standard ringing) and external incoming or Attendant calls (discriminating ringing). The system can also be programmed to provide discriminating ringing for all calls.

Standard Ring	1 second on, 3 seconds off.
Discriminating Ring	0.4 seconds on, 0.2 seconds off, 0.4 seconds on, 3 seconds off.

Ringing Plan

The SX-200 EL and SX-200 ML systems are fully compatible with the North American public switched network using the North American ringing plan. The ringing plan is stored in the database. Available ringing plans include: Malaysia, Taiwan, Hong Kong, and Mexico.

Ringling Time-Out (Final Ringback)

A call to an extension can ring for 1 to 30 minutes before the call is dropped. The default ringing time is 1 minute.

Satellite PBX

The SX-200 EL and SX-200 ML systems can be installed as a satellite PBX. In this configuration, the PBX has no direct connection to the serving central office for incoming traffic. Enabling the satellite PBX system option automatically adjusts any required settings for the loss and level plan.

Secretarial Line

A SUPERSET telephone programmed with a secretarial multicall line appearance of another extension can override the Do Not Disturb feature on the second set. In a typical operation the second telephone has Do Not Disturb active and the first telephone answers the calls. The secretary can override Do Not Disturb at any time by making the call on one of the multicall appearances of the second telephone's Prime Line. If it is important to contact the second telephone, the first telephone can ring the second telephone, despite the Do Not Disturb feature. See Line Types and Appearances for information on multicall appearances.

Speak@Ease Support (Mitel Networks 6500 Speech-Enabled Applications)

Users of the Speak@Ease softkey can place a call by a spoken command. The Mitel Networks Speech-Enabled Applications is the name of the software that enables the Speak@Ease button functionality.

Speaker Volume Control

Users of a SUPERSET telephone can adjust the volume of the telephone's speaker.

Speed Call Key

This feature allows a SUPERSET telephone user to save frequently dialed telephone numbers and to access these numbers by pressing a single key. Only unassigned Line Select keys can be used to save Speedcall numbers. Access codes for features such as Directed Call Pickup, Remote Call Hold Retrieve, and Call Forwarding may be programmed into Speedcall numbers. See Call Forwarding.

SUPERSET telephone users can include a pause character in the speed dial numbers they program on their telephones. This allows them, for example, to dial through an auto attendant to an extension, or to dial an internal voice mail machine and password with a single keystroke. This feature also makes it easier to send out a FAX and to access long distance service providers. The ability to insert a pause is available to SUPERSET 4015, SUPERSET 4025, SUPERSET 4125, SUPERSET 4150, SUPERSET410, SUPERSET420, SUPERSET 430, SUPERSET 3DN and SUPERSET 4DN telephones.

Users of Speed Call key can also use a Speed Call key while they are on a call. This is useful if you need to enter a frequently used account code after you are connected to the number you called.

Split

Split allows a SUPERSET telephone user, engaged in a conference call, to split the call between the conferees. Once active, swapping can take place between the calls, or the conference can be reestablished.

Station Message Detail Recording (SMDR)

Station Message Detail Recording (SMDR) allows data to be collected for each outgoing and incoming trunk call. This data can be output to a printer or a data recording device for subsequent processing.

Subattendant - Basic Function

This feature provides a SUPERSET telephone with enhanced recall and call queuing capabilities, allowing the set to be used as a subattendant position.

Any calls that are handled by the subattendant will recall the subattendant instead of the attendant. Recalls to the subattendant ring the set's prime line.

Usually, a SUPERSET telephone is considered to be busy when the set and/or the prime line appearances are busy. For a Subattendant, the set is busy only if the prime and all of the appearances of the prime line are busy. The state of the SUPERSET telephone itself is not checked. This allows as many callers as there are appearances to call the SUPERSET telephone under some circumstances. This special line appearance checking makes the set a better backup position.

The Night/Day Switching - SUPERSET display telephones feature can be used to allow the subattendant to select DAY, NIGHT1, or NIGHT2 service for the system. The Subattendant telephone can also be used as the Alternate Trunk Recall point. Note: This Subattendant - Basic Function feature is not related to, and does not interact with, the Subattendant - Enhanced Function features.

Subattendant - Enhanced Functions

The Enhanced Subattendant functions allow a SUPERSET 4150, SUPERSET 430 and SUPERSET 4DN telephone to be used as a Subattendant station for multi-tenanting, consoleless operations (but can be used in conjunction with a Console) where call clearing of twenty five calls per hour is considered to be busy. The functions of the SUPERSET 4150, SUPERSET 430, and SUPERSET 4DN telephone remain intact; the Enhanced Subattendant functions are an addition.

The Enhanced Subattendant position can perform functions for extension users; set up and cancel Call Forwarding, set up and cancel Advisory Messages, and toggle Do Not Disturb on and off. The Enhance Subattendant features include

- System Abbreviated Dial Programming
- Station Advisory Message Programming
- Station Call Forward Setup and Cancel
- Calls Waiting Indication
- Hold Positions - 6
- Listed Directory Number (LDN) Keys - 6
- Enhanced Zone Paging
- Station Do Not Disturb Setup and Cancel
- System Date and Time Setup
- Enhanced Recalling Capabilities.

Subattendant - Abbreviated Dial Programming

The Subattendant - Abbreviated Dial Programming feature allows the Subattendant to program system abbreviated dial numbers from the Subattendant set. The Subattendant has the option of making abbreviated dial numbers confidential.

Subattendant - Advisory Message Setup

There are eight default messages and seven programmable messages that the Subattendant may set up on behalf of another extension. The Subattendant can read a currently displayed message, or read through the available messages and choose one for display on the set, or program one for display.

Subattendant - Wakeups

This feature allows a SUPERSET 4150, a SUPERSET 430, or SUPERSET 4DN telephone programmed as a subattendant to set up wakeup alarm calls that ring the guest room telephone at a prearranged time. With MOSS Option 102 (Feature Level) enabled to level 1 or greater, users of the SUPERSET 4150 and SUPERSET 430 subattendant telephones can program wakeup calls (multiple and personal) that occur once or repeat daily. You may set a maximum of three wakeup calls in a 24-hour period. Personal wakeup calls issue a callback to the subattendant telephone so you may personally provide a wakeup to the VIP guest. The programmed wakeup times can be changed or cancelled.

Subattendant - Call Forward Setup and Cancel

This feature allows the Subattendant to setup, review and cancel Call Forwarding for any extension. The extension for which the Subattendant sets up forwarding need not have any of the Call Forwarding features in its COS. The Subattendant may also set up Call Forwarding from the extension to the Subattendant. All forwarding types can be setup or canceled in this function, whether or not forwarding types have been previously defined for either the Subattendant or the affected extension.

Subattendant - Calls Waiting Indication

The Calls Waiting indicator appears in all call processing states and is displayed in the Subattendant C/W (Calls Waiting) area of the display. The Calls Waiting indicator appears in the top right corner of the display, directly below the area where the Forwarding flag appears. The Call Waiting flag takes precedence over the Message Waiting and Mic On flags when clashes occur.

The Subattendant may have calls from outside trunks and extensions queued that are waiting to be answered. The number shown by the Calls Waiting Indicator is the total number of calls in the queue. This includes only calls ringing LDN's (or the Recall key) that appears on the Subattendant set and any calls ringing the night bell. Each new call ringing the Subattendant position increments the indicator; similarly, the indicator is decremented each time a caller hangs up.

Subattendant - Date and Time Setup

When the Subattendant position is idle, it continually displays the time and date (day, month year) on the LCD display. The time may be displayed in 12- or 24-hour format depending on the system feature settings. The Subattendant can change the time and/or date by using the Subattendant SUPERKEY and softkeys.

Subattendant - Hold Positions

This feature provides the Subattendant with up to six hold position keys. When enabled, the hold position keys permit the Attendant to answer other LDN or Prime lines without having to release current calls on the Subattendants telephone first. The Subattendant can transfer a current incoming call to one of the hold positions by selecting the corresponding hold position key. The call is then placed in the hold position, releasing the prime line for the Subattendant to receive another incoming call.

The indicator for the hold position to which the call has been transferred flashes, indicating to the Attendant that a call is currently occupying that hold position. The Add Held softkey appears when an incoming call is transferred to a hold position. Should all programmed hold positions at a Subattendant position become occupied, incoming calls on the Subattendant prime line may be placed on hold by selecting the red hold key. The red hold key places the incoming call on a hard hold on the Subattendant prime line, but since the line is occupied subsequent LDN calls cannot be answered until the call on hard hold is released.

Note: The Add Held prompt softkey is provided to permit the Subattendant to pickup calls currently in hold positions and add them to an existing conversation on one of the set's active lines to create a three party conference.

Subattendant - Listed Directory Number (LDN) Keys

Each Subattendant can have up to six keys programmed as Listed Directory Number (LDN) keys. The LDN keys appear on the Subattendants telephone line keys. The LDNs may be programmed to appear on other Subattendant telephones or Attendant Consoles to permit greater call handling flexibility. When this occurs, the COS and Tenant of the Subattendant LDN

is taken from the Subattendant or Console with the lowest bay, slot and circuit on which the LDN is programmed.

The LDN keys and the Recall key act as call queueing indicators. Unlike line keys, they cannot be selected to dial on and conversations cannot be held on them. When a Subattendant LDN call is answered, the call is automatically connected to the prime line of the Subattendant telephone. Each LDN position can be programmed as the answer point for a trunk or reroute destination for a particular type of call. To ensure that the prime line is free to answer any LDN calls, the Subattendant prime line cannot be programmed to appear on other devices. The Subattendant can answer a LDN call three ways:

- Going off-hook, where the longest waiting LDN call is then automatically connected to the Subattendants prime line
- Selecting the speaker key, where the longest waiting LDN call is then automatically connected to the Subattendant prime line
- Selecting the LDN key directly.

LDN keys with “ring type” set to NO RING are not automatically selected when the Subattendant goes off-hook (or select the Speaker key), therefore they must be selected manually by selecting the No Ring LDN Key. Once answered by the subattendant, an LDN call is treated as though it were a regular call received on a SUPERSET telephone, with the exception of Serial Calls.

Subattendant - Paged Hold Access

The Subattendant can place an incoming call on hold, page the called party and inform them of the digits to dial. The called party can then pick up the incoming call directly from the Subattendant hold position. When the Subattendant accesses a PA Pager with a call on hold, the Hold Pickup Access code is displayed along with the Subattendant identifier code. The Subattendant would then instruct the paged party to call those digits followed by the hold position number. See Paging - PA.

Subattendant - Recall

The Recall feature ensures that calls do not remain unanswered or on hold for an unlimited period of time. Any calls that have been extended by a Subattendant, recalls the Subattendant position if the call is not answered or remains on hold at the end of the timeout period. The LDN keys and the Recall key act as call queueing indicators. Unlike line keys; they cannot be selected to dial on and conversations cannot be held on them. When a Subattendant Recall is answered, the call is automatically connected to the prime line of the Subattendant telephone.

To ensure that the prime line is free to answer any Recall calls, the Subattendant prime line cannot be programmed to appear on other devices. To avoid Recalls tying up the prime line of the Subattendant it is important to program the Recall key. Recalls to the Subattendant will then be queued on the Recall key. The Subattendant can answer a Recall call three ways:

- Going off-hook, where the longest waiting Recall call is then automatically connected to the Subattendants prime line
- Selecting the speaker key, where the longest waiting Recall call is then automatically connected to the Subattendant prime line
- Selecting the Recall key directly.

For further information on the Recall feature refer to Recall.

Subattendant - Station DND Setup

The Subattendant may set up or cancel Do Not Disturb (DND) for an extension by selecting the Do Not Disturb softkey. Selection of the Do Not Disturb softkey turns the feature on. Selecting the softkey when the Do Not Disturb feature is activated, turns the feature off. The status change will be indicated on the Subattendants display and on the corresponding extension. See Do Not Disturb.

SUPERSET 3DN and SUPERSET 4DN Auto-Answer For Directed Page Calls

This feature enables users to respond handsfree to a directed page. If a directed page from a telephone is broadcast over the user's set, the set microphone is activated automatically allowing the user to speak handsfree to the calling party.

The Auto-Answer for Directed Page Calls feature is only available on SUPERSET 3DN and SUPERSET 4DN telephones. Note that the Handsfree Answerback feature provides a similar type of functionality for SUPERSET 410, SUPERSET 420, SUPERSET430, SUPERSET 4025, SUPERSET 4125, and SUPERSET 4150 telephones.

SUPERSET 3DN and SUPERSET 4DN Option

With LIGHTWARE 17, Release 3.1 and greater software, support for SUPERSET 3DN and SUPERSET 4DN telephones is a purchasable option. To use these sets, you must enable COS Option 98 "Support 3DN and 4DN Set Types" in Form 4, System Options/System Timers. SUPERSET 3DN and SUPERSET 4DN telephones are not supported in SX-200 EL/ML Release 2.0 or Release 3.0 software.

The SUPERSET 3DN telephone has 12 keys with LCD indicators available as Speed Call keys, Feature Access keys or Line Appearances. The lowest key must be the Prime Line appearance. In addition to these 12 keys, there is one red key (hold) and 9 fixed function keys.

The SUPERSET 4DN telephone can have up to 11 speedcall numbers and one line appearance (Prime Line). The set can alternately have up to 12 line appearances (including Prime Line) and no speedcall numbers. In addition to these 12 keys, there is one red key (hold), the SuperKey, four feature keys and six softkeys. The SUPERSET 4DN telephone incorporates a liquid crystal display (LCD) for line status indication, user prompting and displays such as message waiting, time and date.

SUPERSET LCD Display

The SUPERSET 4015, SUPERSET 4025, SUPERSET 4125, SUPERSET 4150, SUPERSET 420, SUPERSET 430, SUPERSET 3DN, and SUPERSET 4DN telephones are equipped with a liquid crystal display (LCD). The display (not to be mistaken for the LCD line appearance indicators) indicates the date and time of day, along with softkey names for the set's softkeys. A redial number is displayed, if applicable. Also, when a SUPERSET display telephone accesses a trunk and establishes a call, the duration of the call is displayed.

Swap (Trade Calls)

This feature permits a SUPERSET telephone user to switch the conversation between two calls. Call Swap places one call on hold while conversation continues with the other call. This feature is similar to the Broker's Call feature available on industry-standard telephones.

Swap Campon

This feature allows the user of a SUPERSET telephone to put the current call on hold and speak with a camped on party. The telephone user can alternate between the two calls as required, form a three-party conference, or release the telephone from the call, leaving the other two parties connected. This also applies to members of hunt groups. The first extension in the hunt group that does not have Do Not Disturb activated and is logged in (UCD agent hunt groups) is able to swap in the first waiting caller on the hunt group.

System Fail Transfer (SFT)

System Fail Transfer (SFT) (or power fail transfer) is provided by the SFT control port, allowing preselected DTMF or rotary telephones to be connected directly to CO trunks in the event of system failure in the PBX.. To provide system fail transfer, the system requires an external SFT unit or SPINE Bay LS/CLASS trunks. SUPERSET telephones and consoles cannot be System Fail Transfer extensions.

System Identifier

A unique one- to three-digit identifier may be assigned to the system. It appears on traffic measurement and SMDR reports to identify the system when central polling equipment is used for Traffic Measurement, Trunk SMDR, ACD, Data SMDR, ACD SMDR, and Analog Networking.

System ID Module

The system ID module enables operation of the features that were purchased. Removal of the system ID module generates a MAJOR alarm and causes an error code on the Main Control Card.

Tandem Operation

The SX-200 EL and SX-200 ML systems support two PBXs connected in tandem using tie trunks to connect the two systems together. See the Analog Networking, Satellite PBX, and Resale Package features.

TAPI Support Over DNIC

This feature allows a PC to control first-party calls. The PC runs a TAPI-compliant software application that communicates with the system via the RS232 serial port in a SUPERSET 4150 or SUPERSET 4125 telephone.

Tenanting

Using the tenanting feature, up to 25 small businesses, or departments of a larger business, can share the services of an SX-200 EL/ML system. Each tenant can be provided with customized features and services.

Toll Control

The Toll Control feature forms part of the Automatic Route Selection (ARS) feature. It allows the system to restrict external calls placed by designated groups of extensions. This may mean denying all outside calls, denying calls to specific locations, denying calls over expensive routes, or any combination of these. See Automatic Route Selection (ARS) and Class Of Restriction (COR).

Tone Demonstration

The tone demonstration feature familiarizes users with the tones the system generates. This feature also allows SUPERSET telephone users to adjust ringer volume and pitch.

Tone Plans

Numerous tones can be generated when dialing telephone numbers. To accommodate these, the system loads the required country tone plan from the PCMCIA card. Separate software loads containing the required tone plans are available. Loading the appropriate software allows the system to operate in countries that do not use the North American tone plan. Available tone plans include: North America, Malaysia, Taiwan, Hong Kong, and Mexico.

Traffic Measurement

Traffic measurements can be made on SX-200 EL and SX-200 ML systems. The results are printed through a printer port (see Printer / Terminal Support). Traffic measurements include totals for

- Console activity
- System activity
- DTMF, pseudo DTMF, and CLASS Receiver activity
- DTRX Calls
- Feature activity
- Guest Room activity
- Hunt Group activity
- Line and Trunk activity
- PCM Channel activity
- Trunk activity
- Trunk group activity.

Information is accumulated during a user-programmed time period, and is then available for output. Programming is done from the Maintenance Terminal or from the Attendant Console.

Transfer

This feature allows a telephone user, on an established call, to put the call on consultation hold, dial a third party, and transfer the second party to the third party. The transfer can be done before the third party answers, after the third party answers, or if the third party is busy.

Transfer Dial Tone

The transfer dial tone feature supplies a tone to indicate that an extension has a call on consultation hold. Transfer dial tone is returned when an extension places an established call on hold to consult with another party or to transfer the call. Transfer dial tone is 350/440 Hz, three bursts of 100 ms on, 100 ms off, followed by continuous tone. Regular dial tone is 350/440 Hz continuous tone.

Transfer Security (Recall)

This feature is designed to prevent the dropping of mishandled calls. If an extension, during transfer, hangs up before completing dialing, or if the transfer is not allowed, the call that was placed on hold by the original extension flashing, automatically calls back to that extension. This also applies to conference calls.

Trunk Answer From Any Station (TAFAS)

This feature allows the user to answer incoming calls appearing at common alerting devices (night bells). The user can answer calls for a single tenant or for all tenants in the system. The answering extension can then invoke any feature associated with the incoming call that is normally available at that extension. TAFAS can also be used to answer certain calls which ring at the console during the day.

Trunk Circuit Descriptor Options

Trunk circuit descriptors specify the programmable hardware parameters of each trunk circuit in the system. Each trunk in the system must have a trunk circuit descriptor number with an associated set of selected options.

Trunk Dial Tone Detection

After accessing a trunk the system tries to detect dial tone on it. If dial tone is detected before time-out, the system begins sending digits. If no dial tone is detected after the time-out period and limited wait is specified, the system automatically begins sending digits.

Trunk Groups

Trunk groups are defined and used in the ARS forms in CDE to control extension access to trunks, to define trunk options, and to apply features to trunk groups.

Trunk Operation - Direct Inward Dial (DID)

DID trunks allow incoming trunk calls to reach extensions without Attendant intervention or assistance. The length of the incoming number, the number of digits to be absorbed, and a

prefix digit, if required, can also be specified through CDE programming. Calls arriving at the system on DID type trunks are assumed to be outside calls. Callers therefore receive different call progress tones. Call handling differs from Tie and DISA trunk type calls, which are assumed to be internal calls.

Trunk Operation - Direct Inward System Access (DISA)

The DISA feature allows an external caller to access the system by dialing the directory number of a special DISA trunk and then dialing a security code. After the code is dialed the system returns Dial Tone to the caller, who may then access any features in the DISA trunk's COS which do not require a Switch Hook Flash. Optionally, the external caller can be required to enter a special account code rather than the standard DISA Access Code. See Account Codes - Verified (Special DISA), DISA trunks can be supported on many different hardware types. See Trunk Support - T1, Trunk Support - DID, Trunk Support - E & M. A trunk can be programmed as DISA at all times, or during night service only.

Trunk Operation - Non-Dial-in CO

CO trunks usually carry calls between the local central office and the PBX. Calls arriving on CO trunks are assumed to be outside callers. Callers therefore receive different call progress tones. Call handling differs from Tie and DISA trunk type calls, which are assumed to be internal calls. CO trunks are assigned an origination point for DAY, NIGHT1, and NIGHT2 service. They can optionally be assigned as a dedicated line on a SUPERSET telephone. The NIGHT1 or NIGHT2 service for CO trunks can be changed directly from the Attendant Console.

Trunk Operation - Tie

Tie trunks allow incoming trunk calls to reach extensions directly, without attendant intervention or assistance. The number of digits expected from the trunk is unknown. Digit absorption and adding prefix digits can be done. Calls coming into the system on Tie type trunks are assumed to be callers from inside the company, similar to DISA trunk type calls. The callers therefore receive the same call progress tones that internal callers hear and may have access to many extension features.

Trunk Recall

The Trunk Recall feature provides an alternate recall point for trunks in the system. The alternate recall point can be specified for each tenant and each NIGHT/DAY service. Under the following conditions, trunks are rerouted to the alternate call point:

- For all trunk types, when an extension with a trunk on Consultation Hold is listening to reorder tones and times out. The trunk is removed from consultation hold and rerouted.
- For DISA and CO trunks, when a trunk recalls from campon or ringing an extension. See Recall.

Trunk Support - CO (LS/GS)

The SX-200 EL and SX-200 ML systems support CO (LS/GS) trunks with the LS/GS Trunk card in digital bays. The SX-200 SPINE supports LS/CLASS trunks with the LS/CLASS trunk module. The SX-200 rackmount cabinet supports LS/CLASS trunks with the LS/CLASS Trunk card.

Trunk Support - Direct Inward Dial (DID)

The DID trunk types supported are Wink Start, Delay Dial and Immediate Dial. DID Trunks support Tie, CO, DID, and DISA operation.

Trunk Support - E&M

E&M trunks are supported with the E&M Trunk module on the Universal Card in digital peripheral bays. The signaling schemes supported include: Type I and Type V, 2-wire or 4-wire. E&M trunks support Tie, CO, DID, and DISA operation.

Trunk Support - T1

T1 trunks are supported using T1/D4 Channel Associated Signaling (CAS), also referred to as DS1. T1 Trunk cards support DID, Tie, CO, and DISA operation on a per circuit basis. For each circuit, the circuit descriptor can be programmed through CDE to alter the signaling scheme to one of: E&M, DID/Loop-Tie, CO (loop and ground start), DISA E&M, DISA DID/Loop-Tie, DISA CO (loop or ground start).

The system provides a Stratum 3 or 4 clock source as an integral part of the Main Control Card. The system can be used in master mode to serve as a clock source for the network, or in slave mode to use the network as its clock source. In slave mode the system prevents data losses due to clock rate differences by adjusting its internal T1 clock module to remain in phase with the incoming frame clock rate.

Uniform Call Distribution (UCD)

Uniform Call Distribution (UCD) concentrates incoming trunk traffic onto one or more special agent hunt groups. Trained operators (Agents) answer the calls. If all Agents are busy, the caller camps on and may be connected to a recording hunt group, where the caller hears recorded announcements. The caller retains his position in the queue. If the Agents are still busy when the recording ends, the system connects the call to Music-on-Hold (if provided). After a pre-determined time, the unanswered call is rerouted to a designated answering point.

Vacant Number Intercept

Calls to unassigned (vacant) access codes can be routed to a given answering point for completion. This point can be an LDN position on the Attendant Console or any valid routing point. Vacant number intercept points can be programmed to be different or the same for DAY, NIGHT1, and NIGHT2 modes of system operation.

Voice Mail Support

The SX-200 EL and SX-200 ML systems support the following Voice Mail functionality:

- Centralized Voice Mail
- Voice Mail on COV Ports
- Voice Mail on DNIC Ports
- Voice Mail on ONS Ports

- Mitel Express Messenger
- NuPoint Messenger - Softkey Support.
- Single Button Transfer to Voice Mail.

Centralized Voice Mail: Centralized voice mail allows one voice mail device to service several interconnected PBXs in a SX-200 system with LIGHTWARE 17 or greater software.

Voice Mail on COV Ports: Voice Mail devices may use the Mitel Networks COV interface.

Voice Mail on DNIC Ports: Voice Mail devices may use the Mitel Networks DNIC interface.

Voice Mail on ONS Ports: This feature integrates an SX-200 EL or SX-200 ML system with an ONS Voice Mail system. The integration is based on the use of system abbreviated dial numbers. This eliminates several dialing steps involved in the sending and retrieving of voice mail messages.

MITEL Express Messenger: MITEL Express Messenger allows a single voice mail card to provide either two, four, six, or eight voice mail ports to a system operating with LIGHTWARE 17 or greater software. The voice mail card sits in a peripheral interface card slot.

NuPoint Messenger - Softkey Support: NuPoint Messenger is a PC-based, voice mail and messaging system. Softkey Support allows users to press a softkey instead of dialing single-digit codes to select features. Some other softkey examples are Keep, Discard, Rewind and Fast Forward. Users of sub-attendant consoles and the SUPERSET 420, SUPERSET 430, SUPERSET 4025, SUPERSET 4125, and SUPERSET 4150 telephone can use this feature. Softkey support is only available when NuPoint Messenger has a DNIC connection.

Single Button Transfer to Voice Mail: The Single Button Transfer to Voice Mail feature provides a voice mail key that transfers a caller to a user's voice mail. The voice mail key can be programmed as a feature key, and in some cases can appear as a softkey. The voice mail key functions under two different modes: in a transfer-recall mode, or in a direct mode (no recall).

Whisper Announce

Allows a party to place a directed page to a busy SUPERSET 4025, SUPERSET 4125, SUPERSET 4150, SUPERSET 420, or SUPERSET 430 telephone. A short burst of ringing precedes the voice announcement, advising the busy party that an announcement is following. The announcement is heard through the handset, only by the paged party. The other party will hear silence.

After initiating a Whisper Announce, if the paged party has COS Option 501, Override Announce, enabled, the paging party hears a short burst of ring-back tone and can talk immediately after the burst of ringing.

After initiating a Whisper Announce, if the paged party has COS Option 501, Override Announce, disabled, the paging party hears a short burst of busy tone and must wait for the paged party to respond.

Feature Levels

The MOSS option, Feature Level, provides controlled access to selected features in new software releases. Customers purchasing new systems and software upgrades will receive this option. Software received for bug fixes will NOT receive this option. The Feature Level allows our customers to access selected features in new software releases. The Feature Level option (option 102 in CDE Form 04) will be incremented for major releases of software. The Feature Level status for LIGHTWARE 18, Release 1.0 was 1. The Feature Level status for LIGHTWARE 18, Release 2.0 was 2. The Feature Levels did not increment for LIGHTWARE 19 Release 1.0. For LIGHTWARE 19 Release 2.0 software the Feature Level is 3.

The following table lists the software features that are dependant on the Feature Level option.

Software Features Dependant On Feature Levels		
Feature Level 1	Feature Level 2	Feature Level 3
Call Blocking - Subattendant	BRI Card Support	Single Button Transfer to Voicemail
Call Forwarding - Multiple Destinations	Internal Number Block	Tenant-based Call Forwarding
Call Forwarding - Toggle Keys	ONS Positive Disconnect	Display Caller ID on Non-Prime Lines
Call Logging	Remote Printing of CDE Forms	Paging for PA and Telephones
Emergency Calls (911) - Detection and Reporting to Display Sets		ONS Ring Groups
Off-Hook Alarm to Display Sets		Display Ringing Extension within a Pickup Group
Privacy Release - Default Setting		Sets Paging Other Paging Groups
Reminders - Multiple		
Wakeups - Multiple and Personal		

Purchasable System Options

The SX-200 LIGHTWARE 19 software package includes all the available features. The System ID module, that comes with the software, plugs onto the Main Control Card and contains a specific system ID number. When options are purchased, the Mitel Networks Order Desk will give the purchaser a new Mitel Networks options password that only works with the specific System ID number. The purchasable options are then set to match those on the MITEL Options Selection Sheet (MOSS). The options password then activates the purchased options. All purchasable system options have a part number.

Purchasable System Options	
Option Number On CDE Form 4	System Options
80	MyAdministrator Access
84	Multiple Guest Suite Phones
85	Speak@Ease Integration
86	PRI Card: Q.SIG
87	Record a Call
88	Max TAPI Desktops (0..50 in increments of 5)
89	CLASS functionality for ONS Sets
90	ACD Real Time Event
91	PRI Card: NFAS
92	PRI Card: D-Channel Backup
93	PRI Card: Remote LAN Access
94	PRI Card: Min/Max
95	PRI Card: Auto Min/Max
96	Number of Links (0-8)
97	Support Softkey Access to Voicemail
98	Support 3DN and 4DN Set Types
99	Fax Tone Detection
102	Feature Level
103	Maximum Devices (the number of user devices enabled)
104	Maximum ACD Agents (the maximum number of ACD agents enabled)
105	MITEL Application Interface
106	Automated Attendant
107	Lodging (Hotel/ Motel)
108	Property Management System
109	Remote Software Download
110	Maximum BNIC Cards
111	Maximum BONS Cards
112	SS 4000 Series Sets
113	Centralized Attendant / Voicemail

MyAdministrator Access: Allows you to use the SX-200 MyAdministrator application. This application supports basic moves, adds, and changes to the telephones on single or multiple SX-200 system sites.

Multiple Guest Suite Phones: Groups a number of telephone lines through interconnected hotel or motel rooms (suites), for the purposes of billing and shared telephone services.

Speak@Ease Integration: Enables you to have access to 6500 Speech-Enabled Applications directly (offhook) or indirectly (softkey). The Speak@Ease softkey is available on SUPERSET 420, SUPERSET 430, SUPERSET 4025, SUPERSET 4125, and SUPERSET 4150 telephones. The 6500 SE Applications system is a speech recognition application that routes incoming calls to a specific destination based on spoken commands.

PRI Card: Q.SIG: Allows you to connect PBXs from different vendors together to form a private network. Q.SIG currently supports incoming calls and incoming Calling Name.

Record a Call: Allows you to record an internal or an external two-party conversation and save the conversation in a voice mailbox.

Max TAPI Desktops (0..50 in increments of 5): Enables a PC to control first-party calls with a SUPERSET 4125 or a SUPERSET 4150 telephone.

CLASS functionality for ONS Sets: Allows analog telephone sets to show the calling party name and number during the ringing state and the talking state (campon).

ACD Real Time Event: Enables text strings to represent call events as they happen in ACD.

PRI Card: NFAS (Non-Facility Associated signaling) NFAS allows you to use a single D-channel to handle the signaling requirements for a group of PRI links that use the same Protocol. This feature eliminates the need to purchase a D-channel for each link. NFAS is mainly for North America.

PRI Card: D-Channel Backup Used for signaling to establish and maintain the circuit, and to send user data. D-channel Backup provides an alternate D-channel for calls related to NFAS. If the active D-channel fails, the system switches to the backup D-channel to support call processing. This functionality is mainly for North America. NFAS is required in order to program D-channel Backup.

PRI Card: Remote LAN Access Provides LAN access to the wide area network (WAN) for both incoming and outgoing calls through LAN servers (for example, routers, bridges) using Mitel's PRI Gateway interface.

PRI Card: Min/Max Controls the number of simultaneous incoming and outgoing calls. The level of control ranges from generic minimums and maximums on all calls to minimums and maximums for particular directory numbers.

PRI Card: Auto Min/Max Works in conjunction with Min/Max, and increases Min/Max configurations by providing time of day programming. Time of day programming allows you to have consistent traffic control without having to frequently reprogram Min/Max. You can program call control for an entire week, and the system will automatically change Min/Max settings based

on the time of day and the day of the week. Min/Max is required in order to program Auto Min/Max.

Number of Links (0-8): Limits the number of T1 type links from the PRI card and BCC III. This option is not required for links provided by the ISDN Network Gateway or a T1 trunk card. The total number of purchasable links and ISDN Network Gateway and T1 links cannot exceed 8.

Support Softkey Access to Voicemail: Enables voicemail softkeys on SUPERSET 4025, SUPERSET 4125, SUPERSET 4150, SUPERSET 420, and SUPERSET 430 telephones. Voicemail softkeys are supported by MITEL Express Messenger and by the DNIC-based NuPoint Messenger system.

Support 3DN and 4DN Set types: Enables the programming for SUPERSET 3DN and SUPERSET 4DN telephones.

Fax Tone Detection: Enables the system to recognize the FAX tone on incoming calls to the Automated Attendant. System Option 106, Automated Attendant, must be enabled as well. **Maximum Devices:** Displays the maximum number of user devices enabled, from 24 through 768, in increments of 24.

Feature Level: Allows our customers to access selected features in the release. The Feature Level option (incremented for each Feature Level) is a purchasable MOSS option, number 102 in the System Options and Timers, CDE Form 04. The Feature Level for LIGHTWARE 19, Release 2.0 is 3. The feature level is obtained with all new installs and software upgrades but not with software fixes.

Maximum Devices: Displays the maximum number of user devices enabled, from 24 through 768.

Maximum ACD Agents: Displays the maximum number of ACD agents enabled, from 0 through 100, in increments of 5. This is the maximum number of agents that can be logged in concurrently.

MITEL Application Interface: Enables the MITEL Application Interface Package (MAI).

Automated Attendant: Enables the Automated Attendant Feature Package which supports FAX Tone Detection.

Lodging (Hotel / Motel): Enables the Hotel / Motel feature package. Lodging and Property Management System are mutually exclusive.

Property Management System: Enables the Property Management System (PMS). Lodging (Hotel/Motel) and Property Management System are mutually exclusive.

Remote Software Download: Allows the user to upgrade the system from a remote site. The PCMCIA Memory Card on the Main Control Card must be the four megabyte variant.

Maximum BNIC Cards: Specifies the quantity of BNIC cards that have been purchased as part of a package. No additional BNIC cards can be purchased separately. The quantity entered must exactly match the quantity on the MOSS sheet.

Maximum BONS Cards: Specifies the quantity of BONS or BONS CLASS cards that have been purchased as part of a package. No additional BONS cards can be purchased separately. The quantity entered must exactly match the quantity on the MOSS sheet.

SS 4000 Series Sets: Allows programming of SUPERSET 4000-series telephone sets.

Centralized Attendant / Voicemail: Allows the system to program and access centralized attendant or voicemail facilities.

Maintenance

Introduction

Reliability is a key factor in the choice of any communications system. The SX-200 system is rugged, designed to operate under a wide range of conditions. No expensive equipment room or air conditioning is required. If problems should arise, built in diagnostics and service aids assist the maintainer in quickly isolating and repairing the fault.

Usability is critical, not only for telephone users, but for system installers and maintainers. The system's modular construction makes installation simple and straightforward. Once the system is installed, the customer data entry features can be carried out through the attendant console, a VT100 compatible terminal, or a personal computer with a VT100 emulator, often without any wiring changes.

Customer Data Entry (CDE)

Customer data entry is accomplished from the VT100 terminal, a PC with a VT100 terminal emulation package, or from the system console. The console LCD guides the installer or maintainer through the data entry procedure by displaying a series of prompts and listing the required steps to be performed. The console displays four lines of 80 characters each. The two top lines display the steps to be taken; the two bottom lines display the prompts that define the 10 function keys on the system console.

All CDE programming is done through a series of English language programming forms, with each form made up of a number of data fields. System features, operation, calling restrictions and toll control are customized to your needs by entering the appropriate data or enabling the appropriate options in the CDE forms. All CDE data is entered using the softkeys on the console, or the keyboard on the terminal and PC.

To ensure the system always meets your changing requirements, authorized personnel can modify the system's CDE entries at any time by altering the entries in the appropriate forms.

```

11:16 AM 28-JUN-00                alarm status = MINOR

FORMS
01 = SYSTEM CONFIGURATION          02 = FEATURE ACCESS CODES
03 = COS DEFINE                    04 = SYSTEM OPTIONS/SYSTEM TIMERS
05 = TENANT INTERCONNECTION TABLE 06 = TENANT NIGHT SWITCHING CONTROL
07 = CONSOLE ASSIGNMENTS          08 = ATTENDANT LDN ASSIGNMENTS
09 = DESKTOP DEVICE ASSIGNMENTS    10 = PICKUP GROUPS
11 = DATA CIRCUIT DESCRIPTOR     12 = DATA ASSIGNMENT
13 = TRUNK CIRCUIT DESCRIPTORS    14 = NON-DIAL-IN TRUNKS
15 = DIAL-IN TRUNKS              16 = TRUNK GROUPS
17 = HUNT GROUPS                 18 = MISCELLANEOUS SYSTEM PORTS
19 = CALL REROUTING TABLE        20 = ARS: COR GROUP DEFINITION
21 = ARS: DAY ZONE DEFINITION      22 = ARS: MODIFIED DIGIT TABLE
23 = ARS: ROUTE DEFINITION        24 = ARS: ROUTE LISTS
25 = ARS: ROUTE PLANS            26 = ARS: DIGIT STRINGS
27 = ARS: MAXIMUM DIALED DIGITS   28 = FORM ACCESS RESTRICTION DEF

ENTER FORM NUMBER: _

6-QUIT      | 7-TOP      | 8-BOTTOM   | 9-         | 0-
    
```

CC0571

Maintenance Terminal CDE Forms Display

Maintenance Functions

The objectives of the maintenance functions are to isolate a fault to a replaceable card or module. Maintenance functions can be performed from either the attendant console or an RS-232 terminal. A connector for a remote maintenance terminal is provided on the rear panel of the cabinet.

Information presented on the maintenance terminal includes

- System date, system time
- Current system alarm level
- System identification number
- Maintenance data display area
- Command entry line
- Softkey labels (softkeys 1 to 5)
- Softkey labels (softkeys 6 to 0).

Information presented on the four-line console LCD display includes

- System date, system time
- Command entry line
- Softkey labels (F1-F5)
- Softkey labels (F6-F0).

When the console is used for maintenance, the maintenance output data is displayed on the LCD.

Alarm Indication

The system has four alarm levels: no alarm, minor, major, and critical. Minor alarms indicate problems affecting a portion of the system, such as failure of a line or trunk circuit. Major alarms indicate problems causing a system-wide degradation of service. Critical alarms indicate serious problems that cause automatic activation of System Fail Transfer. The current alarm status is indicated on the upper right corner of the maintenance terminal, and on the top line of the attendant console LCD display. The system maintainers can adjust the alarm thresholds to suit the customer's requirements. The alarm types are adjustable for different percentages of devices unavailable.

Alarm LEDs

All peripheral cards such as lines, trunks and receivers have one red alarm LED. The system lights the LED if the card fails a diagnostic test, or if the card is installed in a wrong or nonprogrammed card slot.

Alarm Status Display

The maintainer can display current system alarm levels for the entire system or for separate categories. The categories are

- Lines
- Trunks
- DTMF receivers
- PCM channels.

Configuration Report

The configuration report allows the maintainer to display the system configuration showing the location of major devices down to the level of the modules installed on cards in the peripheral bays.

Copy Database

The maintainer can make a backup copy of the system database onto a storage medium on a PC.

Customer Data Entry (CDE) Backup and Restore

This feature allows customer data to be dumped onto a storage medium on a PC, and also allows new generic software to be loaded into the system from a PC.

Device Error Analysis Statistics

The SX-200 EL and the SX-200 ML systems record errors detected during the operation of datasets, HDLC links, and T1 trunks. Maintenance personnel can generate statistical reports based on this data.

Device Status Report

The maintainer can display the status of any peripheral circuit or circuits by entering a command at the maintenance terminal. The information displayed includes: circuit location, circuit type, call processing state and maintenance state.

Diagnostics

The SX-200 EL and SX-200 ML systems have a comprehensive diagnostic package. The diagnostics test the operation of the system hardware. The main control system controls and schedules the diagnostics.

There are three types of diagnostic routines:

- Power-up
- Background
- Directed.

Power-up diagnostic routines consist of the complete set of diagnostics for the system. When enabled, they are executed upon system power-up and may last several minutes. These diagnostics will perform a rigorous check on the response and performance of the hardware and firmware. Any failures will be displayed on the LED display and the RS-232 terminal (when requested), and logged in a file on the NVRAM.

The background diagnostic routines consist of the complete routines which are run during system operation. When enabled they are executed as low priority background routines during system operation.

Directed diagnostics are diagnostic routines that are selected by the maintenance person and then run on specified circuits or devices.

Upon power-up or reset conditions, the diagnostics software (if enabled) has temporary control of the entire system. Once the system has been verified and is operational, the diagnostics run as low priority background tasks.

Modular design and functional packaging of the equipment permits rapid location and replacement of defective components. Circuit malfunctions are detected by diagnostic routines automatically initiated by the Main Control Card. Diagnostic routines direct service personnel to the defective circuit card or assembly, and identify the required field-replaceable unit. Diagnostic routines and maintenance procedures do not interfere with users unaffected by the malfunction.

Remote Maintenance Administration and Test (RMATS) Access

RMATS allows personnel at a central maintenance center to access the SX-200 EL or SX-200 ML system and retrieve maintenance data or make programming changes.

Remote Printing of CDE Reports

CDE reports are generated and captured on the remote terminal so the user can obtain a softcopy of the reports and print them. CDE Form 32, CDE Data Print, has two new softkeys: DISPLAY and DISPLAY ALL. These softkeys are equivalent to the PRINT and PRINT ALL softkeys; causing the selected print option to be executed but with the data reflected back to the terminal. The softkeys are dependant on System Option 102, Feature Level 2 or greater.

Remote Software Download

Remote software download allows a system software upgrade to be performed from a PC connected to a system. System software to be loaded onto the maintenance PC can be obtained by subscribing to the Mitel Networks subscription service. At the system, System Option 109 - Remote Software Download must have been purchased and enabled. The PCMCIA Memory Card on the Main Control Card must be the four megabyte variant for this option.

Remove from Service, Return to Service

The maintainer can remove a line, trunk, or receiver circuit from service for maintenance. Removing a circuit from service makes it inaccessible to call processing; it remains so until the maintainer returns it to service.

Show, Set Date

The maintainer can show and set the system date from the maintenance terminal.

Show, Set System Time

The maintainer can show and set the system time from the maintenance terminal.

SUPERSET Firmware Download

The SUPERSET 4025, SUPERSET 4125, SUPERSET 4090, and the SUPERSET 4150 telephones are outfitted with flash ram that contains firmware. The firmware can be upgraded using the firmware download maintenance commands. This makes it possible to download new firmware in the field to add new functionality to the SUPERSET telephones.

System Logging Facility

The SX-200 EL and SX-200 ML systems keep a system event log. Each time the maintenance state of a device changes, or a major event occurs such as a card installed in the wrong slot, the system generates a log report. These log reports can be read, printed, or deleted from the maintenance terminal or console.

Test Line Function

The test line, in addition to normal extension features, has access to maintenance and testing features. By entering DTMF digits, service personnel can perform the following maintenance functions

- Busy out any channel on the system
- Busy out any peripheral device in the system except consoles and the test line circuit
- Print the system maintenance log on to the system printer
- Select any trunk in the system from the test line
- Return to service any channel on the system
- Stop print the system maintenance log on to the system printer
- Return to service any peripheral device that was previously removed from service via maintenance
- Stop testing the printers on the system
- Test any channel on the system
- Test any peripheral circuit in the digital bays
- Test any printer on the system, other than the system printer using the physical location number of the printer port
- Test any printer on the system (except the system printer) using the extension number of the printer port
- Test the system printer.

Maintenance Diagnostics

This section briefly describes the maintenance diagnostics for the system. These diagnostics test the operation of the system hardware. The main control system controls and schedules the diagnostics.

Upon power-up or reset conditions, the diagnostics software (if enabled) has temporary control of the entire system. Once the system has been verified and is operational, the diagnostics run as low priority background tasks.

Background diagnostics, a complete routine test that runs during system operation, runs once a day at 4 a.m , if enabled.

Modular design and functional packaging of the equipment permits rapid location and replacement of defective components. Circuit malfunctions are detected by diagnostic routines automatically initiated by the Main Control Card. Diagnostic routines, detailed in the General Maintenance Information section, and the Troubleshooting section of the SX-200 Technical Documentation, direct service personnel to the defective circuit card or assembly, and identify the required field-replaceable unit. Diagnostic routines and maintenance procedures do not interfere with users unaffected by the malfunction.

Maintenance Objectives

The objectives of the maintenance routines are to isolate a fault to a replaceable card or module. Maintenance functions can be performed from either the attendant console or a RS-232 VT-100 maintenance terminal.

RS-232 Maintenance Terminal

The main control system interfaces to an RS-232 VT-100 maintenance terminal and to the Attendant Console to enable the user to access the diagnostic menu. The diagnostic menu will direct the user through the required procedures in order to interrogate the status of the diagnostic subsystem. The user can initiate maintenance routines with specific parameters via the terminal. Refer to the RS-232 Maintenance Terminal section in the SX-200 Technical Documentation. Results can be routed to the appropriate device (printer or terminal) according to the user's instructions.

Diagnostic Log Files

A file of the major occurrences in the diagnostic system is maintained in NVRAM. This file can be directed to the RS-232 maintenance terminal, the attendant console, or a printer.

Types of Diagnostics

There are three types of diagnostic routines:

- Power-up
- Background
- Directed.

Power-up diagnostic routines consist of the complete set of diagnostics for the system. When enabled, they are executed upon system power-up and may last several minutes. These diagnostics will perform a rigorous check on the response and performance of the hardware and firmware. Any failures will be displayed on the LED display and the RS-232 terminal (when requested), and logged in a file on the NVRAM.

The background diagnostic routines consist of the complete routines which are run during system operation. When enabled, the background diagnostics runs once a day at 4 a.m. By default, the background diagnostics are disabled.

Directed diagnostics are diagnostic routines that are selected by the maintenance person and then run on specified circuits or devices.

Database Installation and Updates

The database can be installed or updated from a maintenance terminal or PC with terminal emulation connected to the SX-200 EL or SX-200 ML Maintenance connector. Backup copies of the database can be stored on a PC or on one of the PC's floppy disks. There are no storage devices on an SX-200 EL or SX-200 ML system.

Database Storage on Loss of Power

The customer data entry database is stored on RAM and backed up onto a non-volatile RAM (for up to 68 hours during loss of power) on the MCC. Upon system power-up, the database is transferred from NVRAM to the MCC RAM. Customer data entry information can also be kept on a remote PC for retrieval in case of major system failures. Other system information such as switchhook flash timing, trunk timings, and rotary digit translation for different countries, is routed to the peripheral control systems for processing.

Specifications

By offering a balanced set of features and system configurations, the SX-200 EL/ML system becomes an ideal communications center for installations of up to 650 telephones. This translates into a system with the power and flexibility to meet today's needs that is easily expanded to accommodate tomorrow's changing requirements.

Nonblocking digital bays, busy hour call attempts (BHCA) to 2765, and traffic capacity exceeding 3400 CCS make sure that the SX-200 EL/ML system is available when you need it.

Environment

The SX-200 EL or SX-200 ML system should be located in an area that is dry, clean, well ventilated, well lit, and readily accessible.

Shipping

The equipment is designed to withstand shipping by truck, rail, air, or sea without damage, when packaged in conventional shipping containers supplied by the manufacturer.

Storage

The following table lists the range of environmental conditions that the equipment is capable of withstanding in storage.

Storage Conditions	
Specification	Range
SX-200 EL/ML System	
Temperature Range	-20° C to 66° C (-4° F to 150° F) for the SX-200 system -40° C to 66° C (-40° F to 150° F) for the SX-200 SPINE bay and modules -20° C to 60° C (-4° F to 140° F) for the console
Relative Humidity	5 % to 95% RH at 18° C (64.4° F) non-condensing 10% to 70% RH for the console
Vibration	0.5 g (4.903 m/s ²) (sinusoidal) 5 to 100 Hz 1.5 g (14.7 m/s ²) (sinusoidal) 100 to 500 Hz
Shock	Up to 75 cm (30 in.) drop depending upon package
Mechanical Shock	Up to 61 cm (24 in.) drop on any face or corner Up to 75 cm (30 in.) drop of SPINE bay and modules
Low Pressure	87 mm Hg 15,152 m (50,000 ft)
Temperature Shock	-40° C to 21° C (-40° F to 70° F) in 5 minutes 66° C to 21° C (150° F to 70° F) in 5 minutes
Page 1 of 2	

Storage Conditions (continued)	
SX-200 IP Node	
Temperature	0° C to 40° C (32° F to 104° F)
Humidity	15 to 95% Relative Humidity, non-condensing
Vibration	0.5 g, 5 to 100 Hz, any orthogonal axis 1.5 g, 100 to 500 Hz, any orthogonal axis
Mechanical Stress	One 15.3 cm (6 in.) drop, each edge and corner adjacent to the rest face – unpackaged One 76.2 cm (30 in.) drop, each edge and corner packaged in cardboard & foam.
Page 2 of 2	

Site

Site Conditions		
SX-200 EL/ML System		
Operating Temperature	0 to 40° C	32 to 104° F
Relative Humidity (Operating) (non-condensing)	20 to 80%	20 to 80%
Heat Dissipation (approximate)	500 BTUs / hr	
Maximum Altitude	4000 m	13,000 ft.
SX-200 IP Node		
Operating Temperature	15° to 35° C	59° to 95° F
Relative Humidity (Operating) (non-condensing)	40 to 90%	
Heat Dissipation - fully loaded*	724 BTUs/hr	
Air Flow		150 cubic feet per minute at maximum output of the fans
Acoustic Emission		Maximum 50 dBA continuous, 75 dB intermittent (<10% duty cycle)
* Conversion factors: 1 watt is equal to 3.412 BTUs per hour, 1 ton of refrigeration is equal to 12,000 BTUs per hour or 3.516 Kilowatts, and 3/4 Kilowatt-hour is equal to 1 ton of refrigeration		

Feature Capacities

The SX-200 EL and SX-200 ML systems offer a wide range of features through software packages. These are outlined in the Features Description section of this guide. A full description appears in the SX-200 Technical Documentation under Program Features. Maximum capacities that apply to system features are listed in the following table.

Feature Capacities	
Feature	SX-200 EL/ML Limitations
Maximum number of simultaneous calls - 2 cabinet configuration - 7 cabinet configuration	90 248
Maximum number of speech paths or channels used by any call any call with DTMF	2 3
Maximum number of simultaneous consultations	5
Maximum number of simultaneous add-on (3-way) calls	5
Maximum number of simultaneous station-controlled conference calls	5
Maximum number of parties in conference at one time	5
Maximum number of calls that can simultaneously be camped on to a station, trunk group, or hunt group	247
Maximum number of simultaneous callbacks that can be enabled	100
Maximum number of simultaneous call forwards that can be enabled	650
Maximum number of simultaneous "Dial 0" calls	48
Maximum number of ONS telephones ringing simultaneously per bay	32
Maximum number of messages queued in the system	750
Maximum number of hunt groups	99
Maximum number of hunt groups in ACD	99
Maximum number of ACD agents that may be defined	999
Maximum number of active agents in ACD per bay	25
Maximum number of calls that can be simultaneously connected to Music-on-Hold	unlimited
Maximum number of stations in a station hunt group	50
Maximum number of stations in a call pickup group	50
Maximum number of dial call pickup groups	50
Maximum number of trunks assignable to night stations	200
Maximum number of trunks in a trunk group	50
Maximum number of trunk groups	50
Maximum number of calls that can override a given extension	1
Maximum number of attendant consoles	11
Maximum number of attendant consoles on a Digital Line Card	4
Maximum number of calls that can be simultaneously held by one attendant	8
Maximum number of incoming calls that can be separately identified at the attendant console	8
Maximum number of LDNs that can be identified at the attendant console	9

SX-200 General Information Guide

Feature Capacities (continued)	
Maximum number of LDNs	100
Maximum Number of Night Bells	25
Maximum number of calls waiting that can be displayed at console	99
Maximum number of calls that can be waiting at console	200
Maximum number of abbreviated dial numbers	1000
Maximum number SUPERSET Speed Dial numbers	2212
Maximum number of trunk buffers for SMDR	200
Maximum number of DATA SMDR buffers	128
Maximum number of stations of SUPERSET 4001, SUPERSET 4015, SUPERSET 4025, SUPERSET 4125, SUPERSET 4090, SUPERSET 4150, SUPERSET 401+, SUPERSET 410, SUPERSET 420, SUPERSET 430, SUPERSET 3DN and 4DN telephones, DSS /BLF Interface Units, and ONS ports.	650
Maximum number of user devices (all sets, stations, trunks, consoles, stand alone datasets, and DMP units)	768
Maximum number of TAPI desktops running simultaneously per system	50
Maximum number of telephone sets using TAPI running simultaneously per bay	24
Maximum number of telephone sets using TAPI per Digital Line card	3
Maximum number of lines:	
SX-200 EL Control cabinet	96
SX-200 ML (RM) Control cabinet	96
SX-200 ML (FD) Control cabinet	96
SX-200 ML (FD) Control cabinet with Control FIM Carrier	84
SX-200 ML SPINE bay	48
SX-200 Peripheral cabinet	96
Maximum number of ISDN bays	6
Maximum number of BRI cards in a cabinet	2
Maximum number of T1 links including analog, ISDN Gateway, and ISDN PRI card links	8
Maximum number of T1 links per system	8
SX-200 EL	8
SX-200 ML	4
Maximum Number of Page Groups	50
Maximum Number of Paging Zones	9
Maximum Number of Stations in a Page Group	unlimited
Maximum Number of Sub-attendants	25
Maximum Number of LDN Appearances	16
Maximum Number of Line Appearances	32
Maximum Number of Physical Ports	
SX-200 EL	672
SX-200 ML	192
Page 2 of 2	

System Parameters

The sale and installation of any communications equipment is subject to various local and national regulations covering a number of parameters including electrical characteristics, tone plans, and loss and level plans. In addition, the traffic capacity of the system must be considered - will the system handle the expected traffic at cut over and can it be expanded to cover expected growth in the future?

This section of the guide lists many of these system parameters that can be used for preliminary planning. For additional SX-200 EL/ML planning information, refer to Engineering Information on the SX-200 EL/ML Technical Documentation CD-ROM.

Tone Plan Support

The SX-200 system supports tone plans for the following countries:

- North America
- Mexico
- Hong Kong/Taiwan
- Malaysia.

Traffic and Performance

Traffic Parameters

Traffic engineering is a statistical method used to ensure that you have provisioned your system to give the level of service to which your users are accustomed. Understanding these traffic engineering concepts is important when purchasing or configuring your system.

Early analog PBXs usually had a large number of voice ports contending for a low number of speech paths. Once all the speech paths were in use, anyone trying to place a new call was forced to wait for the next free path. To reduce the chance of being unable to complete a call, customers with high traffic could give users enough speech paths by installing large PBXs with more ports and thus more speech paths.

The introduction of digital systems replaced speech paths with call connections and channels. Using time division multiplexing, a single piece of wire could now carry up to 32 simultaneous conversations. The result was a system that was physically smaller but able to carry many more calls. These systems were often referred to as non-blocking, implying that all users of the system could be placing calls at the same time, and a lack of system resources would not prevent any of these calls from being completed.

To improve system efficiency, PBXs are normally engineered so callers are competing for limited system resources such as trunks. This contention allows the system to make better use of trunks by scheduling callers on each trunk. Most users are unaffected by this as a higher percentage of traffic in a system is traditionally with inside parties. Key Systems force users to manually select outgoing lines as most of their traffic is external calls.

Another factor which must be considered is traffic peaks. Although most system analysis is done using average traffic, maximum peaks must also be identified. If traffic in any period exceeds these specified maximums, system performance will likely degrade, and over-competition for resources may result. Once traffic drops below this peak, the system will provide normal performance. When purchasing a system, ratings for system peak capacities should be determined for your configuration rather than using the average figures for the product line.

Here are some facts about the SX-200 EL/ML system relating to traffic.

- (a) The systems provide for at least 200 simultaneous call connections. This means that 200 stations can talk to 200 other stations or trunks before call connections could create blocking.
- (b) In peripheral digital bays the concentration of ports to channels is 96:90. This means that if only 90 devices are installed in a digital bay there is no possibility of blocking on channels. Adding Datasets could increase the number of devices to the point where some blocking for channels could occur. Statistically, however, there should be limited performance impact.
- (c) To withstand peaks in traffic, Mitel Networks rates its switches according to line size using the very heavy traffic patterns stipulated in ATT0048.

Mitel Networks also tests the systems to ensure that they can withstand twice the traffic specified for the line-size of the switch. This is to ensure that peak traffic will not impact system performance under normal conditions.

The SX-200 EL/ML system also contains a traffic measurement package to help monitor actual traffic patterns. This traffic information must be considered when additional lines and trunks are added to an existing system. For example, information on dial tone delays may indicate a need for additional receiver modules. Console pegs can indicate the need for additional console positions. Trunk usage reports can indicate the need for additional trunks.

Use the traffic report figures as guidelines. Specific departments or trunks may not follow the averages of the rest of the system. This should be understood and analyzed to ensure that your system can meet the needs of all users.

To aid in configuring your system, the following chart can help you in determining the number of trunks required. For this chart to be effective certain assumptions have been made. If your system does not fit with these assumptions, then consult your dealer or sales representative.

Assumptions:

- (a) Traffic patterns are approximately
 - 33% internal
 - 33% outgoing
 - 33% incoming.
- (b) Trunks are both-way, as these are most efficient for carrying traffic.
- (c) An adequate number of receivers are present. Rule of thumb is 4 receivers per 60 telephones.
- (d) Target grade of service is P.01 or the same as the level which most telephone companies provide.

To use the chart you must determine your average traffic levels for the busiest hour of the day. Divide the number of calls for this hour by the number of telephones on your system.

- 1 call per hour = light traffic
- 2 calls per hour = medium traffic
- 3 or more calls = heavy traffic

On the bottom axis of the chart select the number of telephones in your installation. Choose the line on the graph that represents your traffic level. The left axis indicates the recommended number of trunks.

Special applications (such as ACD) should be highlighted to your dealer or sales representative.

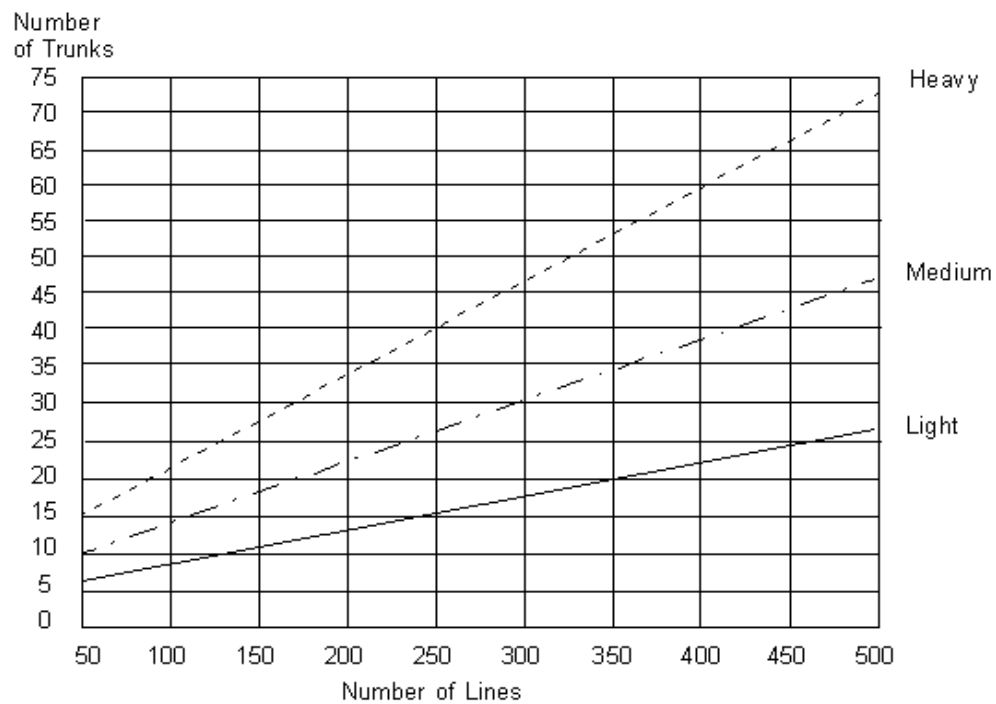

Grade of Service

The SX-200 EL/ML Grade Of Service (GOS) in terms of blocking is outlined below.

SX-200 EL/ML Grade Of Service (GOS)	
Link/Resource Blocking	Blocking Probability
Link Blocking	
Peripheral to Network	< 0.1%
Network to Network	0.0%
Resource Blocking	
Software	< 0.01%
DTMF Receivers, Trunks	provisioning-dependent

Traffic Limitations

Traffic capacities are specified on a per line basis in terms of calls per hour and Erlangs.

The tabulated voice traffic call rates defined in the tables below are based on actual laboratory traffic tests with SUPERSET 430 telephone sets originating and terminating calls. Set type, trunk/ARS programming, and maintenance reporting options all affect overall system performance. Therefore, system performance will vary depending on customer selected options.

Voice Reference Call Rates (per hour)		
Configuration	Rated	Peak
Single cabinet with 96 ports and 19 E&M trunks	730	1222
Single cabinet with SPINE Peripheral Bay 132 ports and 23 LS/CLASS trunks	852	1350
Dual cabinet with 180 ports and 29 trunks	1422	2087
Five cabinets with 480 ports and 63 E&M trunks	3206	4177

Bothway Traffic Capacity			
Configuration	Mean Calls/Hour	Peak Calls/Hour	Erlang (mean)
Dual cabinet ACD with 50 lines and 48 trunks (24 per cabinet)	1226	1848	63.17
Dual cabinet ACD with 100 lines and 96 trunks (24 per cabinet)	2790	3697	103.22

Typical configured system quantities as per ATT 48002 are:

Light - 10 %		Medium - 50 %		Heavy - 90 %	
Lines	Trunks	Lines	Trunks	Lines	Trunks
75	8	75	12	75	19
50	6	50	10	50	15
25	5	25	7	25	10

Receiver Provisioning

This section provides receiver requirements for DTMF and CLASS receivers. DTMF receivers are a shared system resource with provisioning done on a system level. CLASS receivers are dedicated to the modules on their associated SX-200 SPINE.

The MCC contains seven receivers which can be programmed as DTMF receivers or as DSP circuits in System Option 68, DSP DTMF Receiver Channels (0...7 default = 7) to optimize performance.

Seven SX-200 SPINE CLASS/DTMF receivers can be allocated as CLASS or DTMF, with a maximum of five CLASS receivers (default is three CLASS and four DTMF). System Options 61-67 can be selected to optimize performance based on the proportions of ONS to LS/CLASS modules in each SX-200 SPINE Bay.

DTMF receivers can also be provided by adding DTMF Receiver/Relay modules to a Universal Card. Each module contains four DTMF receivers.

Calculate receiver provisioning requirements for an SX-200 EL or SX-200 ML system using the following table.

Calculating Receiver Requirements		
Step	Calculation	Result
1.	Calculate the total number of ports that may require access to a DTMF receiver. Ports include: <ul style="list-style-type: none"> • analog DID trunks • digital DID trunks • digital E&M trunks • ONS ports • OPS ports • COV ports 	Total ports = _____
2.	Determine the expected traffic level for your system and select the appropriate divisor: <ul style="list-style-type: none"> • very heavy traffic (ACD / internal auto attendant)15 • heavy traffic 20 • medium traffic 25 • light traffic 30 	Divisor = _____

Calculating Receiver Requirements (continued)		
3.	Divide the total ports from step 1 by the divisor in step 2. Round the answer up to the next whole number. This is the total number of DTMF receivers required.	Total DTMF receivers required = _____
4.	If SPINE bays are present, determine the number of available DTMF (non-CLASS) receivers (set by System Options 61 - 67) on the SPINE Control Modules.	Available SPINE DTMF receivers = _____
5.	Add the number of available SPINE DTMF receivers (step 4) to the number of receivers on an SX-200 EL or SX-200 ML MCC (set by System Option 68) to determine the total number of already available receivers.	Total available DTMF receivers = _____
6.	Subtract the total available DTMF receivers (step 5) from the total DTMF receivers required (step 3) to determine the quantity of additional DTMF receivers required.	Additional DTMF receivers required = _____
7.	Divide the additional receiver requirement (step 6) by 4 (round up to the next whole number) to determine the number of receiver modules required.	DTMF modules required = _____ Note: Receiver modules require a Universal Card which holds up to 4 modules.
Page 2 of 2		

SX-200 SPINE CLASS Receivers

The table below can be used as a guideline to determine CLASS receiver requirements. This receiver provisioning is based at the SX-200 SPINE level.

If a CLASS receiver is not available, the call is not dropped, although the calling line information is lost. Users may determine their own level of urgency on this calling line information when determining their receiver requirements.

Assumptions made for this example of receiver requirements

- CLASS hold time = 4.51 seconds average for incoming traffic
- For ACD applications the 100% of total traffic is assumed for the incoming traffic
- For heavy traffic conditions p.999 is recommended.

CLASS Receiver Requirements for Heavy Traffic					
LS/CLASS Circuits	Total Calls per hour	Incoming Percentage of total traffic	CLASS rcvr Traffic Load Erlangs	Required CLASS receivers for ERLANG B Grade of Service	
				P.99	P.999
4	50	35%	0.02	2	2
	50	100%	0.06	2	3
8	99	35%	0.04	2	2
	99	100%	0.12	2	3
12	144	35%	0.06	2	3
	144	100%	0.18	3	3
16	251	33%	0.10	2	3
	251	100%	0.31	3	4
20	360	31%	0.14	2	3
	360	100%	0.45	3	5
24	478	31%	0.19	3	3
	478	100%	0.60	4	5
28	594	30%	0.22	3	4
	594	100%	0.74	4	5
32	730	29%	0.27	3	4
	730	100%	0.91	5	6
36	829	29%	0.30	3	4
	829	100%	1.04	5	6
40	962	28%	0.34	3	4
	962	100%	1.21	5	7
44	1095	28%	0.38	3	4
	1095	100%	1.37	6	7
48	1226	28%	0.43	3	4
	1226	100%	1.54	6	7

Note: Shaded configurations exceed number of system allowable receivers (5)

The table below describes receiver combinations that are available in a SPINE Bay.

SX-200 SPINE Maximum Receiver Combinations Available	
CLASS Receivers	DTMF Receivers
0	7
1	6
2	5
3	4
4	3
5	1

Physical Characteristics

Physical Characteristics		
SX-200 EL/ML Universal Cabinet		
Cabinet Height	28 cm	11 inches
Cabinet Width	43 cm	17 inches
Cabinet Depth	43 cm	17 inches
Cabinet Weight (cards installed)	21 kg	47 pounds
SX-200 ML (FD) Cabinet and SX-200 LIGHT Peripheral Cabinet		
Cabinet Height	48.0 cm	19.0 inches
Cabinet Width	22.9 cm	9.0 inches
Cabinet Depth	42.0 cm	16.5 inches
Cabinet Weight (cards installed)	19 kg	42 pounds
SX-200 SPINE Peripheral Bay		
Height	18.0 cm	7.0 inches
Width (12 modules plus Control Module)	55.0 cm	21.5 inches
Depth	27.0 cm	10.5 inches
SX-200 IP Node		
Height	7 cm	2.75 inches
Width	48.3 cm	19.0 inches
Depth	39.4 cm	15.5 inches
Weight	7.35 kg	16.19 lb

Electrical Characteristics

All power is derived from either a commercial ac source or an uninterruptible power supply (UPS). All reserve power in the peripheral cabinet can have its own standard reserve power in the base of the SX-200 system or can also be supported by an additional UPS. The UPS assembly is not manufactured by Mitel Networks.

Shelf-Mounted AC Power Supply	
Characteristic	Details
Input Voltage	102 Vac to 135 Vac (pn 9109-008-000-SA) 204 Vac to 270 Vac (pn 9109-008-003-NA)
Frequency	47 Hz to 63 Hz
Holdover Time	Minimum of: 40 ms at 120 Vac or 20 ms at 102 Vac delivering full rated load Maximum 16 ms at 115 Vac input at full load (SX-200 EL/ML)
Input Current	Maximum of: 2.0 Amps at 120 Vac or 1.1 Amps at 240 Vac

Reserve Power Characteristics	
Characteristic	Details
Rating	1.5 kVA minimum
Input Voltage	120 Vrms +10%,-15%, 60 Hz 15%
Output Voltage	120 Vrms +10%,-15%, 60 Hz 5%
Output Waveform	Sine wave or quasi-square wave (not square wave)
Transfer Time	Less than 30 ms (includes fail detection and transfer time)
Output Receptacle	NEMA 15-A three-pin grounded
Holdup/Recharge Times	Per customer requirements

Power and Grounding

The system requires a single-phase, 115 Vac, 15 A circuit. A separate ground wire (size 6 AWG) must be installed between the equipment cabinets and the building ground. The ground wire should be a separate ground wire from the hydro.

In addition to proper grounding, an AC surge suppressor is recommended between the SX-200 system and the 115 Vac outlet for each cabinet. This will protect the equipment from power surges.

All trunks and off-premises extensions should be protected against lightning by gas tubes.

SX-200 IP Node

Output Power	
Output Voltage	Max Current
+3.3 +/- 1.5%	30.0A
+5.0V +/- 1%	8.0A (Total power of 3.3V and 5.0V not to exceed 100W)
+12.0V +/- 7%	3.0A (Hard Disk Drive)

Cabling

The SX-200 EL and SX-200 ML systems use standard male Amphenol 25-pair connectors for cabling between the system and the main distribution frame (MDF). Cables to all industry-standard telephones, SUPERSET telephones, and consoles are either 2- or 4-wire with standard modular connectors.

Cable Lengths

The following rules must be followed for cable lengths between the system and the telephone. Bridge taps are not permitted.

Cable	Maximum Length
Twisted-pair cable (24 or 26 AWG)	1000 m (3200 ft.)
Quad cable (22 AWG)	50 m (160 ft.)
Modular line cord	3 m (10 ft.)
T1 trunk card	200.5 m (655 ft.)

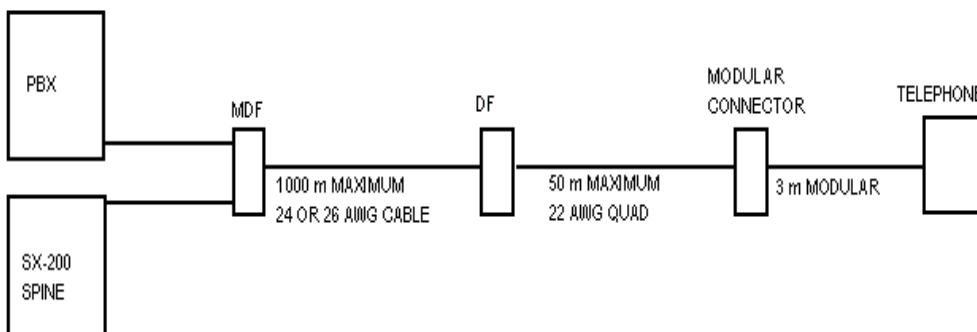

Cable Lengths Between the PBX and the Telephone

Loop Lengths

Loop lengths for various cards are given below:

Card Type	Wire Gauge (AWG)	Loop Length	
DNIC Line Card or DNIC Module (Connected to Digital Telephone)	24	1006 m (3300 ft)	
	26	1006 m (3300 ft)	
	(Connected to DNIC Console)	24	1006 m (3300 ft)
		26	1006 m (3300 ft)
ONS Card	22	3560 m (11700 ft)	
	24	2250 m (7400 ft)	
	26	1400 m (4600 ft)	
ONS Module (SX-200 SPINE)	22	1784 m (5850 ft)	
	24	1128 m (3700 ft)	
	26	700 m (2300 ft)	
OPS Card	22	18290 m (60000 ft)	
	24	11520 m (37800 ft)	
	26	7225 m (23700 ft)	

Card Type	Wire Gauge (AWG)	Loop Length
COV Card	22	2000 m (6600 ft)
	24	1500 m (5000 ft)
	26	1000 m (3300 ft)
E & M Trunk	22	2715 m (8900 ft)
	24	1708 m (5600 ft)
	26	1068 m (3500 ft)
DID Trunk Card - CO Trunk resistance	na	2240 ohms
LS/GS Trunk Card - CO Trunk resistance	na	1600 ohms
LS/CLASS II Module - CO Trunk resistance	na	1600 ohms
T1 Trunk (cable lengths not loop lengths for 22 gauge wire) S1 only closed: 0 - 45.8 m (0 - 150 ft) S2, S3, S4 closed: 45.8 - 137.3 m (150 - 450 ft) S5, S6, S7 closed: 137.3 - 200 m (450 - 655 ft)	22	These are cable lengths, not loop lengths. Set DIP switches on T1 Trunk card for correct equalization depending on cable length between the T1 Trunk and the Channel Service Unit (CSU).
Page 2 of 2		

Regulatory Compliance

The SX-200 EL/ML system meets the following regulatory requirements:

EMC -	United States:	FCC part 15 subpart B - Class "A"
EMC -	Canada:	IC ICES-003 - Class "A"
Safety -	United States	ANSI/UL1459
Safety -	Canada	CAN/CSA-C22 No. 225
Network -	United States	FCC part 68
Network -	Canada	IC CS-03

The FCC Registration Number for the PABX equipment is: BN259C-16891-MF-E, and the SX-200 SPINE is BN2CAN-21456-MF-T. REN is 2.3B.

Glossary of Terms

ABH

See Average Busy Hour, page 231.

ABSBH

See Average Busy Season Busy Hour, page 231.

A/D

See Analog/Digital, page 230.

ADL

See Associated Data Line, page 230.

ASCII

American Standard Code for Information Interchange. It was developed by the American Standards Association for both synchronous and asynchronous data transmission between DTEs. Characters consist of an 8-bit binary code and incorporated parity bits.

Abbreviated Dialing

Abbreviated dial gives users the ability to dial abbreviated speed call codes, which substitute for a system wide list of frequently-called numbers. These numbers can be displayed or programmed at the attendant console or the maintenance terminal.

Absorbed Digits

In certain call processing functions performed by the SX-200 EL/ML system, it may be necessary to suppress the onward transmission of certain digits received in a dialed sequence of digits. This digit absorption is required for applications such as DID calls and ARS purposes. See also digit modification.

Alarms

There are three categories of urgency of fault condition on the SX-200 EL/ML system: minor, major, and critical.

Minor alarms indicate problems affecting a portion of the system, such as failure of a line or trunk circuit. Major alarms indicate problems causing a system-wide degradation of service. Critical alarms indicate serious problems that cause automatic activation of system fail transfer.

Analog/Digital (A/D)

Implies the transformation of analog signals (such as normal telephone speech signals) into their equivalent digital data signals. The device in general use that performs this transformation is called an A/D converter. The device that converts digital signals into their analog form (if required), is called a D/A Converter.

Analog Transmission

The transmission of a continuously varying signal. For example, in the transmission of speech the magnitude of the signal at any instant in the transmission path is proportional to the magnitude of the original input. This type of transmission is distinct from digital transmission in which the original input is encoded (for example, CODEC) and the resulting line signal is in digital form.

Answering Point

A device to which an incoming call is directed. It usually consists of an industry-standard telephone or an attendant console. Under certain conditions an answering point may be a hunt group, a trunk, an ACD path or a device such as a night bell, an answering machine or a recorder/announcer machine.

Application Processor

A processor containing one or more application programs which meet a customer's particular needs; for example, a hospital, a governmental agency or a university environment. The processor is usually arranged to be accessed directly by an input/output device. However, it can be connected to the SX-200 EL/ML system by means of suitable interface arrangements, and therefore be capable of access by suitable input/output devices which are also connected to the SX-200 EL/ML system.

Application Program

See Application Processor.

Associated Data Line

A DTE connection to an SX-200 EL/ML system by means of a dataset which has an associated telephone set. The user sets up a data call by dialing an access code and destination dataset number.

Asynchronous Mode

In asynchronous data transmission the time between bytes (characters) is indeterminate and depends upon external factors. The transmitted data has its own start and stop elements, and thus controls the receiving device. See also Synchronous Mode.

Attendant

The person assigned to handle calls appearing at the attendant console.

Authorized Access Codes

The SX-200 EL/ML system can only be accessed for programming, maintenance or administration purposes by first entering an authorized access code (user name and password).

Autobaud Detection

Some data communication equipment can determine, on receipt of one or more characters, the baud rate of the transmitting source. It then sets its own receive circuits to accommodate this baud rate. In the SX-200 EL/ML system this feature is applicable to datasets and to the maintenance/CDE port which automatically adjusts its baud rate to match that of the terminal during the initial setting up procedure.

Automatic Route Selection

Automatic route selection software automatically selects the optimum trunk route when a user makes a call. This selection is based on many factors, including cost, user priority, the day, and time of day.

Average Busy Hour (ABH)

The clock hour that has the highest average business day traffic (see Busy Hour, page 232.).

Average Busy Season Busy Hour (ABSBH)

This is the hour calculated to have the highest average business day traffic load during the three highest traffic months of the year.

B Channel

The B channel is the 64-K bit channel of a DNIC device. It can carry digitized voice or ASCII characters at a maximum rate of 19.2 Kb/s.

Battery and Ground Pulsing

A method of signaling used on long lines, in which both wires use battery and ground at each end of the circuit. When signaling to the remote end of the trunk, the battery and ground connections are reversed, opposing the potentials at the remote end and increasing the current supply to the trunk.

Blocking

The condition existing in a switching system when the immediate establishment of a call is impossible due to insufficient switching connections being available in the system at that time.

BRI Card

The Basic Rate Interface (BRI) card allows the SX-200 to communicate to Central Offices and devices that support BRI. The SX-200 supports the termination and the origination of ISDN voice and data calls for trunk side and line side U interfaces. The trunk side provides Basic Call and Incoming Calling Name. The line side provides data and voice calls from BRI devices, and voice calls from sets. The BRI card provides up to 12 ISDN BRI U interfaces.

Busy Hour

The hour when a system carries the most traffic (the busiest hour of the busiest day of a normal week).

CCS

A unit used in traffic analysis to denote the traffic occupancy of a switched circuit in a PBX exchange. One CCS represents 100 call-seconds.

CDE

See Customer Data Entry (CDE).

CIM

The CIM (Copper Interface Module) provides a copper communications link between the control cabinet and a peripheral cabinet or a PRI card bay.

COV

See Control Over Voice, page 233.

CP

See Call Processing, page 232.

CLASS

See Custom Local Area Signaling Service, page 234

Call Processing

The software package which handles all aspects of the setting up of connections within the system.

Circuit Switch (CS)

The SX-200 EL/ML system circuit switch provides a matrix of bidirectional switch links. Each circuit switch link accommodates 32 channels. Each channel can be used for a voice or data transmission. Through the circuit switch, any device can be connected to any other device in the system. It is located on the DX Module on the main control card.

The number of links in the matrix depends upon the system configuration.

Circular Hunting

Circular hunting starts at the extension after the last extension in the hunt group to which a call was completed (the extension rung), and hunts overall extensions in the hunt group in the sequence programmed. Hunting stops at the first idle extension found.

Class of Restriction (COR)

A class of restriction controls station and trunk access to trunk circuits. It performs functions similar to toll control and is programmable on a station (or trunk) basis.

Class of Service (COS)

A class of service has a number of different feature options assigned to it. A class of service can be allotted to one or many stations, and enables these stations to have, or be denied, features which are available within the SX-200 EL/ML system. Up to 50 classes of service are available which allow a large number of different groups of station users to be programmed, each with differing feature characteristics.

CODEC

The COder-DECoder is a device used in digital switching and transmission systems, for coding analog signals (voice signals) into a digital format for onward transmission, and decoding a digital transmission to recover the original analog signal.

CODEC/Filter

The CODEC/Filter chip used in the SX-200 EL/ML system consists of a CODEC, a filter and other elements. It forms part of the peripheral card, with the CODEC portion performing the necessary A/D and D/A functions and the filter portion providing low-pass filtering for the line transmission.

Consultation Hold (Soft Hold)

A form of temporary hold. It is used to put a second party on hold while the first party is speaking (consulting) with a third party, or wants to temporarily isolate the second party from conversation.

Control Dual FIM Carrier Card

The card supports up to two Fiber Interfaces Module and connects them to the backplane. It has a 1 km FIM onboard and a connector to plug in a second optional FIM (either a 1 km FIM or an extended FIM).

Control Triple FIM Carrier Card

The card supports up to three Fiber Interface Modules and connects them to the backplane. It has two 1 km FIMs onboard and a connector to plug in a third optional FIM (either a 1 km FIM or an extended FIM).

Control Over Voice

Control over voice is used by the voice mail system to perform most of its signaling functions. A 32 kHz carrier signal is modulated according to the control function, and is transmitted to or from the voice mail system on the same pair of wires used for the audio connection. The carrier frequency lies above the normal audio range of the voice mail system and is therefore inaudible to the user.

Critical Alarm

For each alarm category, the thresholds represent the alarm level trip points; that is, the precise divisions between the alarm levels. The thresholds are simple percentages, indicating availability: the number of working devices is compared to the number of programmed devices. The Critical Alarm threshold is not a percentage, but is a precise numerical value. When the number of available devices falls below this number, a critical alarm is raised.

Cross-Connect Field

See Main Distribution Frame, page 238.

Custom Local Area Signaling Service

An SX-200 EL/ML system permits advanced voice features such as Calling Line ID digits and CLASS Name to accompany or precede the telephone call across multiple switches.

Customer Data Entry (CDE)

Customer data entry (CDE) is the process employed when data particular to a specific customer installation is entered into the SX-200 EL/ML system. This data includes such things as numbering plan, ARS routings, and trunk descriptors. CDE is entered into the SX-200 EL/ML system by the maintenance/CDE terminal.

D Channel

The D Channel is the 16 K bit/s control channel of a DNIC device.

DCE

See Data Communication Equipment, page 235.

DID

Direct inward dialing.

DIL

Direct-in line.

DOD

Direct outward dialing.

DSP

Digital Signal Processor.

DTE

See Data Terminal Equipment, page 235.

DTMF

Dual tone multifrequency signaling.

DTR

Data terminal ready RS-232 pin.

DTRX

Data transceiver.

DX

An abbreviation of the term digital crosspoint, the fundamental switching element of the SX-200 EL/ML circuit switch. The circuit switch is composed of a large number of digital crosspoint switch elements in the form of DX chips.

Data Communication Equipment

Data communication equipment (DCE) interfaces a communications line or data device to data terminal equipment (DTE) over an RS-232 line. A modem and the local maintenance port on the SX-200 EL/ML system are examples of a DCE.

Data Terminal Equipment

Data terminal equipment (DTE) is terminal equipment, usually consisting of a keyboard and video screen or printer, which is used to communicate with a variety of other equipment (i.e. another DTE or a computer).

Default

The value assigned to a particular function which most nearly represents the normal or standard value of the function. A typical default value used in the SX-200 EL/ML system, for example, is a value of 2 minutes allowed before an unanswered ringing extension times out. However this value can be changed in CDE programming from the default value to a value which lies between 1 and 30 minutes.

Digit Modification

The process of restructuring a dialed sequence of digits received by the SX-200 EL/ML system to effectively result in a different sequence of digits. The revised sequence can have new digits added and/or digits deleted (absorbed); or certain digits in the original sequence can be repeated. This process is performed automatically by the SX-200 EL/ML system and is transparent to the user. Digit modification is used in speed calling, tandeming of trunk circuits, processing incoming DID calls, processing calls in ARS, and other applications.

Digital/Analog

A term used in connection with the conversion of digital signals to equivalent analog signals. The original signals are usually in analog form and are converted from analog to digital signals for transmission (see also Analog/Digital, page 230,).

DTRX Messages

DTRX message code used to standardize messages between Mitel Networks PBXs as well as different language text. Intelligent devices can interpret these codes.

E and M

A type of tie trunk. Also the signaling method used for this and for other types of trunks. The term is derived from the use of the E and M leads forming part of the trunk equipment, and taken respectively to denote the receive and transmit leads. The two leads are used to pass supervisory conditions over the trunk.

End Node

A network node that supplies information to the network but does not receive information from the network.

Fiber Interface Module (FIM)

The Fiber Interface Module supports the transmission of voice and data signals over fiber optic cables. The FIM plugs into the Control FIM Carrier.

Forced Account Code

When the forced account code feature is entered in a station's class of service, the user at that station must dial a valid account code each time an outgoing trunk call is made. If it is not entered in a user's COS, the user is denied access to the trunk. The account code appears as part of the SMDR record.

Full Duplex

A method of operation which allows simultaneous transmission from both ends of a communications link.

Ground Button

See Recall Button, page 240.

Ground Start

A particular type of trunk circuit on which a ground condition is applied to the ring lead of the trunk when an outgoing call seizes the trunk.

Hard Hold

A station user, or an attendant, puts another party on hold, and can perform any of the functions which are normally available at the station (as opposed to consultation hold, which restricts the functions which can be performed).

Hot Repair

A system can allow maintenance or repair action to be performed without power being removed from the system first.

Hunt Group

A hunt group is a group of stations to which incoming calls are directed by dialing a master number. Two types of hunting are provided by the system, circular and terminal:

- Circular hunting starts at the extension after the last extension in the hunt group to which a call was completed (the extension rung), and hunts overall extensions in the hunt group in the sequence programmed. Hunting stops at the first idle extension found.
- Terminal hunting starts at the first extension in the hunt group and terminates at the first idle extension found. Hunting takes place in the order in which the extensions were programmed into the hunt group.

Interconnection Restrictions

Certain interconnections between stations and trunks, and between trunk and trunk circuits, are not allowed for various reasons. These interconnections are prevented by setting appropriate parameters in the device interconnection table which is programmed as part of the SX-200 EL/ML CDE procedures. Calls made with trunk circuits are subject to the parameters in the table.

ISDN

The Integrated Services Digital Network (ISDN) accurately transmits voice, data, and video at high speeds without a modem. The SX-200 system with LIGHTWARE 17 Release 4.0 or greater software supports voice with 3.1 kHz audio.

Least Cost Routing

One of the functions of automatic route selection and refers to the economical aspects of the ARS facility. In least cost routing, the trunk circuits are programmed with regard to the effects of the costs of the possible alternative trunk routings. In practice the customer may require the economical aspects to be subordinate to the overall traffic efficiency requirements of the System. For example, less costly trunk routes may be available, but offer too low a traffic grade of service for the customer's needs. Actual requirements may be subject to traffic analysis of the customer's needs.

Link

A link is the system connection that contains 32 channels. Each channel is a digital "speech path". In the SX-200 EL/ML system, there are three links per fibre connection or Bay (Node). Therefore each peripheral node has the equivalent of 3 x 32 or 96 "speech paths" available.

Loop Start

A form of signaling used by a certain type of CO trunk which designates that type of trunk. It denotes an outgoing trunk circuit which is seized by the system placing a loop condition on the trunk.

Loop Tie Trunk

A tie trunk between PBXs which is seized by the application of a loop condition on the trunk. Subsequent supervisory conditions can be determined by the presence/absence of the loop or by battery-reversal conditions.

MCC

Main Control Card.

MDF

See Main Distribution Frame, page 238.

MODEM

A MODulator-DEModulator is a piece of Data Communications Equipment (DCE) that accepts data signals from a piece of Data Terminal Equipment (DTE) and converts them into modulated tone signals suitable for transmission over telephone lines. The DCE at the far end converts the tone signals back into data signals and sends them to its DTE. The data circuit is commonly a duplex circuit; it is capable of operation in both directions simultaneously.

MPU

Main processing unit. In the SX-200 EL/ML system, this refers to the 68000 CPU on the main control card.

Main Distribution Frame

The main distribution frame (MDF) forms the interconnection point between the in-house PBX (for example the SX-200 EL/ML system, and the internal and external cabling to the PBX. The MDF provides a convenient and flexible means of interfacing the cabling to the system. The MDF is also known as the cross-connect field.

Message Subsystem

The message subsystem is one of the subsystem blocks of the SX-200 EL/ML system. Its function is to act as the main message collection and distribution facility for the system, and links the main controller with the intelligent entities at the peripheral level or below. In effect it is the "nervous system" of the SX-200 EL/ML system, in that it passes messages and commands between the lowest and highest levels of the system.

Mixed Station Dialing

The SX-200 EL/ML system caters to the use of both rotary dial and DTMF types of industry-standard telephones installed on the system.

Multiple Consoles

More than one attendant console can be installed on an SX-200 EL/ML system. The trunk groups can be arranged to terminate such that they can be accessed from all of the consoles, and any call can be answered from any console.

ONS

See On-Premises Stations, page 239.

OPS

See Off-Premises Stations.

Off-Premises Stations

Stations which are located at a considerable distance from the parent communication system, and require special circuit terminating arrangements at the system.

On-Premises Stations

Stations which are installed on the same premises as the PBX, or which can operate satisfactorily with the system when installed in adjacent premises without special circuit arrangements

Overlap Outpulsing

A feature used in the SX-200 EL/ML system when making trunk calls. It results in dial pulses (or tones) being outpulsed prior to the receipt of all required digits from the user, the purpose being to reduce the time needed to process the call.

PCB

Printed Circuit Board.

PCM

Pulse Code Modulation.

PKM

Programmable Key Module

Peripheral Equipment

All those external equipments which are connected to the SX-200 EL/ML system, such as stations, telephones, trunks, attendant consoles, and maintenance terminals.

Peripheral Interface Card

A card which provides the interface facilities between the external peripheral equipments, such as stations, trunks and attendant consoles. A prime function is to convert the external analog inputs to the internal digital PCM signals (and conversely convert digital PCM to analog output).

Power Fail Transfer (PFT)

See System Fail Transfer, page 241.

PRI card

The PRI (Primary Rate Interface) card provides SX-200 systems with two links of Primary Rate Access (PRA) to the ISDN service provider. This PRI connection supports the simultaneous transmission of voice and data. Each channel is capable of transmitting voice or data calls at 64 kbps. By interfacing the SX-200 switch with the ISDN service provider, it allows SX-200 users to access ISDN services, such as Direct Dial In (DDI), Calling Line Identification (CLID), and Call By Call Service Selection (CBC).

PRI Gateway

The PRI Gateway is an interface that can include the ISDN Network Gateway, the PRI cards and the Ipera 2000 interfaces.

RS-232C

A North American data interchange standard, issued by the Electronics Industries Association (EIA). The equivalent European standard is the V.24 specification.

Recall Button

This refers to the push-button installed on certain types of industry-standard telephones, for the purpose of providing a ground condition to the line when the button is pressed. When used in conjunction with the SX-200 EL/ML system, pressing the Recall button corresponds to a switch hook flash; for example, when a party is being placed on hold. The button is sometimes referred to as the ground button.

Ring Lead

The second wire of a telephone pair, originally named because it was connected to the "ring" of a telephone plug. The first wire (called the tip lead) was connected to the tip of the plug.

SMDR

See Station Message Detail Recording, page 241.

Second Dial Tone

A user making a trunk call through a system usually receives dial tone after the handset is removed, and then dial tone from the CO after the trunk access code has been dialed. However, the ARS feature of the SX-200 EL/ML system would mask the CO dial tone, because the outpulsing sequences are isolated from the user. To prevent confusion a second dial tone can be provided to the user by the SX-200 EL/ML system (as a programmable option) at the appropriate point in the outpulsing sequence.

Soft Hold

See Consultation Hold, page 233.

Station Message Detail Recording (SMDR)

Station message detail recording (SMDR) records and prints out the details of incoming and outgoing trunk calls in the SX-200 EL/ML system. Such details include the numbers of all parties involved in the call, the time and duration of each call, account codes and other pertinent details.

Store and Forward Dialing

See Overlap Outpulsing, page 239.

SX-200 EL/ML System

The SX-200 EL or SX-200 ML system is a microprocessor-controlled telephone system that handles both voice and data switching. The system hardware is electrically compatible with most single line telephones, MITEL® proprietary sets, key telephone systems, telephone systems, and central office exchanges.

Synchronous Mode

This term is associated with data which is transmitted in a continuous stream at a fixed rate, with the receiving terminal synchronized to the transmitting terminal by means of elements transmitted on a regular basis. See also Asynchronous Mode, page 230.

System Configuration

The particular hardware and software initially installed for the system. Any subsequent additions, deletions and any other changes which occur result in a new system configuration being created. The listing of hardware and software items which comprise the current system configuration can be obtained on command from the maintenance terminal.

System Fail Transfer (SFT)

The system fail transfer feature allows selected stations of the system (or portions of the system, according to the type of outage), to be transferred to certain trunks. Such transfer action is automatic in the event of a failure of the main power supply.

Tandem Trunking

Tandem trunking describes the facility of transparently switching co-located trunks together at the SX-200 EL/ML system. This type of switching is subject to digit modification, and the parameters programmed during CDE for the interconnection restrictions table.

Telco

An abbreviation of tel(ephone) co(mpany).

Terminal Hunting

Terminal hunting starts at the first extension in the hunt group and terminates at the first idle extension found. Hunting takes place in the order in which the extensions were programmed into the hunt group.

Tie Trunks

Tie trunks directly interconnect two systems together. This enables a station, terminated on one of the systems, to be interconnected to any other station, terminated on the other system. With tandem trunking the calling party can be extended through more than one node of the network.

Tip Lead

The first wire of a telephone pair, originally named because it was the lead connected to the tip of a telephone plug. The second wire of the pair (called the ring lead) was connected to the ring of the plug.

Toll Control

Toll control restricts the users to certain trunk routes and denies the use of specific directory numbers. It is part of the ARS feature. Each user is assigned a COR which is associated with the trunk route tables in ARS and determines what degree of access the particular station has to the trunk network.

Traveling Class Marks

In a private network, the caller's class of service can be passed to the destination node to control access to services.

UPS

Uninterruptible power supply.

Via Net Loss (VNL)

The VNL plan automatically applies gain or attenuation (loss) in a predetermined manner to network trunk and toll connections at the switching node points. This results in an acceptable transmission grade of service to subscribers. This term is used in the transmission loss and level plans which are employed within the North American public and private telephone networks.

Wink Start

The wink start feature applies generally to tie trunk circuit operation. When an incoming trunk is seized it may be necessary to prevent the transmission of any digit sequences, until the incoming trunk equipment is ready to receive these digits. When the incoming trunk equipment is ready to receive the digits, a wink start condition is sent from the incoming end to the originating end of the trunk. The distant termination can now send digit sequences over the trunk.